

LOCATING AND ESTIMATING  
AIR EMISSIONS  
FROM SOURCES OF  
DIOXINS AND FURANS

Office of Air Quality Planning And Standards  
Office of Air And Radiation  
U.S. Environmental Protection Agency  
Research Triangle Park, North Carolina 27711

May 1997

## Disclaimer

This report has been reviewed by the Office Of Air Quality Planning And Standards, U.S. Environmental Protection Agency, and has been approved for publication. Any mention of trade names or commercial products is not intended to constitute endorsement or recommendation for use.

EPA-454/R-97-003

## EXECUTIVE SUMMARY

The 1990 Clean Air Act Amendments contain a list of 189 hazardous air pollutants (HAPs) which the U.S. Environmental Protection Agency (EPA) must study, identify sources of, and determine if regulations are warranted.<sup>a</sup> Two of these HAPs, chlorinated dibenzo-p-dioxins (CDD) and chlorinated dibenzofurans (CDF), are the subject of this document. This document describes the properties of dioxins and furans as air pollutants, defines their origin, identifies source categories of air emissions, and provides dioxin and furan emissions data in terms of emission factors and national emissions estimates. This document is a part of an ongoing EPA series designed to assist the general public at large, but primarily to assist State/local air regulatory agencies in identifying sources of HAPs and determining emission estimates.

A dioxin is any compound that contains the dibenzo-p-dioxin nucleus, and a furan is any compound that contains the dibenzofuran nucleus. The term isomers refers to compounds with the same empirical formulas. The term homologues refers to compounds within the same series (e.g., CDD or CDF), but with a different number of chlorine atoms (tetra-CDD, penta-CDF, etc.). The 2,3,7,8-TCDD and 2,3,7,8-TCDF compounds represent the most toxic compounds of their respective families. The nationwide emissions estimate of dioxins and furans presented in this document are based on the two 2,3,7,8 compounds and, to the extent practicable, the base year 1990. In a limited number of cases where more recent data were available (e.g., on-road mobile sources), a different base year was used (1991 or 1992) for estimating nationwide emissions.

CDD and CDF have no known technical use and are not intentionally produced. They are formed as unwanted byproducts of certain chemical processes during the manufacture of chlorinated intermediates and in the combustion of chlorinated materials. Dioxins and furans are emitted into the atmosphere from a wide variety of processes such as waste incineration,

---

<sup>a</sup> Caprolactam was delisted from the list of HAPs (Federal Register Volume 61, page 30816, June 18, 1996).

combustion of solid and liquid fuels in stationary sources for heat and power generation, crematories, iron and steel foundries/scrap metal melting, combustion-aided metal recovery, kraft pulp and paper production/black liquor combustion, internal combustion engines, carbon regeneration, forest fires, organic chemical manufacture and use, and Portland cement manufacture.

The toxicity equivalency factor (TEF) method is an interim procedure for assessing the risks associated with exposures to complex mixtures of CDD/CDF. This method relates the toxicity of the 210 structurally related pollutants (135 CDF and 75 CDD), and the toxicity of the most highly studied dibenzo-p-dioxin, 2,3,7,8-TCDD. The TEF method is used as a reference in relating the toxicity of the other 209 compounds (i.e., in terms of equivalent amounts of 2,3,7,8-TCDD). This approach simplifies risk assessments, including assessments of exposure to mixtures of CDD and CDF such as incinerator flyash, hazardous wastes, contaminated soils, and biological media. In 1989, as a result of the active involvement of EPA in an international effort aimed at adopting a common set of TEFs, a set of TEFs were agreed upon and implemented and were called International TEFs/89 (I-TEFs/89). Toxicity estimates, expressed in terms of toxic equivalents (TEQs), or equivalent amounts of 2,3,7,8-TCDD, are generated by using the TEF to convert the concentration of a given CDD/CDF into an equivalent concentration of 2,3,7,8-TCDD. The I-TEQs/89 are obtained by applying the I-TEFs/89 to the congener-specific data and summing the results. Some emission factors and the national emission totals in this document are presented as TEQs.

Table ES-1 presents national emissions estimates of 2,3,7,8-TCDD, 2,3,7,8-TCDF, and 2,3,7,8-TCDD toxic equivalent (TEQs). As shown in the table, national emissions for 2,3,7,8-TCDD, 2,3,7,8-TCDF, and 2,3,7,8-TCDD TEQ are estimated to be 0.085 pounds, 1.01 pounds, and 4.30 pounds, respectively.

TABLE ES-1. NATIONAL DIOXIN AND FURAN EMISSIONS<sup>a</sup>

Source Category <sup>b</sup>	U.S. Emissions (lb/yr) <sup>c</sup>			Base Year of Estimate <sup>d</sup>
	2,3,7,8-TCDD	2,3,7,8-TCDF	2,3,7,8-TCDD TEQ	
Municipal Waste Combustion	NA	NA	1.61	1995
Residential Coal Combustion	1.16x10 <sup>-2</sup>	3.05x10 <sup>-1</sup>	4.68x10 <sup>-1</sup>	1990
Secondary Aluminum Smelters	NA	NA	3.8x10 <sup>-1</sup>	1990
Medical Waste Incineration	NA	NA	3.32x10 <sup>-1</sup>	1995
Utility Coal Combustion <sup>e</sup>	2.8x10 <sup>-2</sup>	6.8x10 <sup>-2</sup>	3.0x10 <sup>-1</sup>	1990
Industrial Wood Combustion	6.65x10 <sup>-3</sup>	9.51x10 <sup>-3</sup>	2.25x10 <sup>-1</sup>	1990
On-road Mobile Sources	8.06x10 <sup>-3</sup>	1.27x10 <sup>-1</sup>	1.98x10 <sup>-1</sup>	1992
Forest Fires	NA	NA	1.90x10 <sup>-1</sup>	1989
Portland Cement: Hazardous Waste	NA	NA	1.3x10 <sup>-1</sup>	1996
Portland Cement: Non-Hazardous Waste Fired Kilns	NA	NA	1.2x10 <sup>-1</sup>	1990
Wood Treatment	NA	NA	7.62x10 <sup>-2</sup>	1988
Residential Wood Combustion	8.62x10 <sup>-4</sup>	3.01x10 <sup>-2</sup>	6.76x10 <sup>-2</sup>	1990
Sewage Sludge Incineration	9.5x10 <sup>-4</sup>	3.42x10 <sup>-1</sup>	5.29x10 <sup>-2</sup>	1992
Hazardous Waste Incineration	2.40x10 <sup>-4</sup>	2.73x10 <sup>-2</sup>	4.9x10 <sup>-2</sup>	1992
Iron and Steel Foundries	2.52x10 <sup>-3</sup>	8.08x10 <sup>-2</sup>	3.75x10 <sup>-2</sup>	1990
Utility Residual Oil Combustion <sup>e</sup>	8.00x10 <sup>-3</sup>	5.80x10 <sup>-3</sup>	2.2x10 <sup>-2</sup>	1990
Secondary Copper Smelters	1.36x10 <sup>-2</sup>	e	1.36x10 <sup>-2</sup>	1990
Secondary Lead Smelters	1.95x10 <sup>-3</sup>	1.20x10 <sup>-2</sup>	8.49x10 <sup>-3</sup>	1990
Residential Distillate Fuel Combustion	2.82x10 <sup>-3</sup>	2.67x10 <sup>-3</sup>	7.57x10 <sup>-3</sup>	1990
Lightweight Aggregate Kilns (Hazardous waste-fired)	NA	NA	6.92x10 <sup>-3</sup>	1996
Pulp and Paper- Kraft Recovery Furnaces	NA	NA	6.84x10 <sup>-4</sup>	1990
Waste Tire Incineration	1.19x10 <sup>-5</sup>	2.98x10 <sup>-5</sup>	5.94x10 <sup>-4</sup>	1990
Drum and Barrel Reclamation/Incineration	2.12x10 <sup>-5</sup>	3.70x10 <sup>-4</sup>	5.01x10 <sup>-4</sup>	1990
Carbon Regeneration/ Reactivation	1.51x10 <sup>-5</sup>	9.77x10 <sup>-5</sup>	2.49x10 <sup>-4</sup>	1990
Crematories	1.83x10 <sup>-8</sup>	1.33x10 <sup>-7</sup>	NA	
Industrial Waste Incineration	NA	NA	NA	
Municipal Solid Waste Landfills	NA	NA	NA	
Organic Chemical Manufacturing	NA	NA	NA	
PCB Fires	NA	NA	NA	
Scrap Metal Incineration	NA	NA	NA	
Total	8.53x10 <sup>-2</sup>	1.01	4.30	

<sup>a</sup> Estimates presented here are those that were available at the time this document was published. Ongoing efforts and studies by the U.S. EPA will most likely generate new estimates and the reader should contact the Environmental Protection Agency for the most recent estimates.

<sup>b</sup> Source categories are ranked in the order of their contribution to total 2,3,7,8-TCDD TEQ emissions.

<sup>c</sup> Emission estimates are in pounds per year. To convert to kilograms per year, multiply by 0.454.

<sup>d</sup> This is the year that the emissions estimate represents.

<sup>e</sup> The value presented for this source category is a draft estimate and has not yet been finalized by the EPA.

NA = Not Available

Some of the estimates for the non-fuel combustion sources were obtained from reports submitted under the Superfund Amendment and Reauthorization Act (SARA), Title III, Section 313. Other estimates were either calculated from national activity data and the best available emission factor, or taken from other existing EPA inventories such as those prepared under a Maximum Achievable Control Technology (MACT) standard development program (e.g., the national emissions estimate for municipal waste combustors).

In addition to dioxin and furan source and emissions information, several sampling and analytical methods are provided that have been employed for determining CDD and CDF emissions.

## TABLE OF CONTENTS

<u>Section</u>	<u>Page</u>
List of Tables . . . . .	xii
List of Figures . . . . .	xvi
1.0 PURPOSE OF DOCUMENT . . . . .	1-1
2.0 OVERVIEW OF DOCUMENT CONTENTS . . . . .	2-1
3.0 BACKGROUND . . . . .	3-1
3.1 NATURE OF POLLUTANT . . . . .	3-1
3.2 FORMATION OF CHLORINATED DIBENZO-p-DIOXINS AND CHLORINATED DIBENZOFURANS . . . . .	3-6
3.2.1 Combustion Factors Affecting Dioxin/Furan Emissions . . . . .	3-7
Incomplete Destruction of CDD/CDF in Fuel . . . . .	3-8
In-Furnace Formation . . . . .	3-8
Downstream Formation . . . . .	3-9
3.3 TOXIC EQUIVALENCY CONCEPTS AND METHODOLOGY . . . . .	3-9
3.4 OVERVIEW OF EMISSIONS . . . . .	3-11
4.0 EMISSIONS SOURCES . . . . .	4-1
4.1 WASTE INCINERATION . . . . .	4-1
4.1.1 Municipal Waste Combustion . . . . .	4-2
Process Descriptions . . . . .	4-2
Emission Control Techniques . . . . .	4-14
Emission Factors . . . . .	4-17
Source Locations . . . . .	4-17
4.1.2 Medical Waste Incineration . . . . .	4-21
Process Descriptions . . . . .	4-21
Emission Control Techniques . . . . .	4-26
Emission Factors . . . . .	4-28
Source Locations . . . . .	4-28
4.1.3 Sewage Sludge Incineration . . . . .	4-33
Process Description . . . . .	4-34
Emission Control Techniques . . . . .	4-39

TABLE OF CONTENTS, continued

<u>Section</u>	<u>Page</u>
	Emission Factors . . . . . 4-40
	Source Locations . . . . . 4-41
4.1.4	Hazardous Waste Incineration . . . . . 4-41
	Process Descriptions . . . . . 4-47
	Emission Control Techniques . . . . . 4-50
	Emission Factors . . . . . 4-50
	Source Locations . . . . . 4-52
4.1.5	Industrial Waste Incineration . . . . . 4-54
	Process Description . . . . . 4-54
	Emission Control Techniques . . . . . 4-55
	Emission Factors . . . . . 4-55
	Source Locations . . . . . 4-56
4.2	<b>COMBUSTION OF SOLID AND LIQUID FUELS IN STATIONARY SOURCES FOR HEAT AND POWER GENERATION . . . . . 4-56</b>
4.2.1	Utility Sector . . . . . 4-58
	Process Description . . . . . 4-58
	Emission Control Techniques . . . . . 4-59
	Emission Factors . . . . . 4-59
	Source Locations . . . . . 4-59
4.2.2	Industrial Sector . . . . . 4-62
	Process Description . . . . . 4-62
	Emission Control Techniques . . . . . 4-67
	Emission Factors . . . . . 4-68
	Bleached Kraft Mill Sludge Burning in Wood-Fired Boilers . . . . . 4-71
	Source Locations . . . . . 4-72
4.2.3	Residential Sector . . . . . 4-72
	Process Description . . . . . 4-73
	Emission Control Techniques . . . . . 4-74
	Emission Factors . . . . . 4-76
	Source Locations . . . . . 4-81
4.2.4	Waste Tire Incineration . . . . . 4-81
	Process Description . . . . . 4-82
	Emission Control Techniques . . . . . 4-82
	Emission Factors . . . . . 4-82
	Source Locations . . . . . 4-83



TABLE OF CONTENTS, continued

<u>Section</u>	<u>Page</u>
4.3	CREMATORIES . . . . . 4-83
	4.3.1 Process Description . . . . . 4-83
	4.3.2 Emission Factors . . . . . 4-84
	4.3.3 Source Location . . . . . 4-87
4.4	IRON AND STEEL FOUNDRIES/SCRAP METAL MELTING . . . . . 4-87
	4.4.1 Process Description . . . . . 4-87
	4.4.2 Emission Control Techniques . . . . . 4-91
	4.4.3 Emission Factors . . . . . 4-92
	4.4.4 Source Location . . . . . 4-94
4.5	COMBUSTION-AIDED METAL RECOVERY . . . . . 4-94
	4.5.1 Secondary Copper Smelters . . . . . 4-95
	Process Description . . . . . 4-95
	Emission Control Techniques . . . . . 4-98
	Emission Factors . . . . . 4-98
	4.5.2 Secondary Aluminum Production . . . . . 4-99
	Process Description . . . . . 4-101
	Emissions . . . . . 4-107
	4.5.3 Secondary Lead Production . . . . . 4-110
	Process Description . . . . . 4-110
	Emission Control Techniques . . . . . 4-122
	Emission Factors . . . . . 4-124
	4.5.4 Scrap Metal Incinerators . . . . . 4-125
	Process Description . . . . . 4-127
	Emission Control Techniques . . . . . 4-129
	Emission Factors . . . . . 4-129
	4.5.5 Drum and Barrel Reclamation Furnaces . . . . . 4-130
	Process Description . . . . . 4-130
	Emission Control Techniques . . . . . 4-133
	Emission Factors . . . . . 4-133
	Source Locations . . . . . 4-133
4.6	PULP AND PAPER PRODUCTION - KRAFT RECOVERY BOILERS . . 4-135
	4.6.1 Process Description . . . . . 4-135
	4.6.2 Emission Control Techniques . . . . . 4-141
	4.6.3 Emission Factors . . . . . 4-141
	4.6.4 Source Locations . . . . . 4-142
4.7	ON-ROAD MOBILE SOURCES . . . . . 4-142
	4.7.1 Process Description . . . . . 4-144
	4.7.2 Emission Control Techniques . . . . . 4-147

TABLE OF CONTENTS, continued

<u>Section</u>	<u>Page</u>
4.7.3	Emission Factors . . . . . 4-147
4.7.4	Source Locations . . . . . 4-148
4.8	<b>CARBON REGENERATION . . . . . 4-149</b>
4.8.1	Process Description . . . . . 4-150
4.8.2	Emission Control Techniques . . . . . 4-154
4.8.3	Emissions and Emission Factors . . . . . 4-155
4.8.4	Source Locations . . . . . 4-160
4.9	<b>OPEN BURNING AND ACCIDENTAL FIRES . . . . . 4-160</b>
4.9.1	Forest Fires and Agricultural Burning . . . . . 4-160
	Process Description . . . . . 4-160
	Emission Factors . . . . . 4-161
	Source Locations . . . . . 4-162
4.9.2	Miscellaneous Open Refuse Burning and Structure Fires . . . . . 4-163
	Process Description . . . . . 4-163
	Emission Factors . . . . . 4-164
4.9.3	Polychlorinated Biphenyls Fires . . . . . 4-164
	Process Description . . . . . 4-164
	Emissions Data . . . . . 4-165
	Source Locations . . . . . 4-166
4.10	<b>MUNICIPAL SOLID WASTE LANDFILLS . . . . . 4-166</b>
4.10.1	Process Description . . . . . 4-167
4.10.2	Emission Control Techniques . . . . . 4-168
4.10.3	Emission Factors . . . . . 4-169
4.11	<b>ORGANIC CHEMICALS MANUFACTURE AND USE . . . . . 4-169</b>
4.11.1	General Chemical Formation Mechanisms . . . . . 4-169
4.11.2	Chlorophenols . . . . . 4-172
	Chlorophenol Use . . . . . 4-174
	Dioxin and Furan Contamination in the Manufacture and Use of Chlorophenols . . . . . 4-174
4.11.3	Brominated Compounds . . . . . 4-179
4.12	<b>PORTLAND CEMENT PRODUCTION . . . . . 4-180</b>
4.12.1	Process Description . . . . . 4-180
4.12.2	Emission Control Techniques . . . . . 4-185
4.12.3	Emission Factors . . . . . 4-187
4.12.4	Source Locations . . . . . 4-187

TABLE OF CONTENTS, continued

<u>Section</u>	<u>Page</u>
5.0 SOURCE TEST PROCEDURES .....	5-1
5.1 SAMPLE COLLECTION .....	5-1
5.2 SAMPLE RECOVERY AND PREPARATION .....	5-6
5.3 QUANTITATIVE ANALYSIS .....	5-8
6.0 REFERENCES .....	6-1
APPENDIX A METHODS FOR ESTIMATING NATIONAL CDD/CDF EMISSIONS	

## LIST OF TABLES

<u>Table</u>	<u>Page</u>
3-1 Possible CDD and CDF Isomers . . . . .	3-3
3-2 Physical and Chemical Properties of Selected Dioxins and Furans . . . . .	3-4
3-3 International Toxicity Equivalency Factors/89 (I-TEFs/89) . . . . .	3-12
3-4 National 2,3,7,8-TCDD Emissions . . . . .	3-14
3-5 National 2,3,7,8-TCDF Emissions . . . . .	3-15
3-6 National 2,3,7,8-TCDD TEQ Emissions . . . . .	3-16
4-1 Average CDD/CDF Emission Factors for Municipal Waste Combustors . . . . .	4-18
4-2 Summary of Geographical Distribution of MWC Facilities . . . . .	4-20
4-3 CDD Emission Factors for Controlled-Air Medical Waste Incinerators . . . . .	4-29
4-4 CDF Emission Factors for Controlled-Air Medical Waste Incinerators . . . . .	4-31
4-5 CDD and CDF Emission Factors for Rotary Kiln Medical Waste Incinerators . . . . .	4-33
4-6 CDD and CDF Emission Factors for Multiple-Hearth Sewage Sludge Incinerators . .	4-42
4-7 CDD and CDF Emission Factors for Fluidized-Bed Sewage Sludge Incinerators . . .	4-46
4-8 Summary of Total CDD/CDF Concentrations Measured at Hazardous Waste Thermal Destruction Facilities . . . . .	4-51
4-9 CDD/CDF Emission Factors for a Hazardous Waste Incinerator Burning PCB-Contaminated Sediments . . . . .	4-53
4-10 CDD/CDF Emission Factors for an Industrial Waste Incinerator . . . . .	4-57

LIST OF TABLES, continued

<u>Table</u>	<u>Page</u>
4-11 Draft Summary of CDD/CDF Emissions from Composite Coal-Fired Utility Boilers .....	4-60
4-12 Draft Summary of CDD/CDF Emissions from Composite Oil-Fired Utility Boilers ..	4-61
4-13 Total CDD/CDF Emission Factors from Wood Waste Combustion .....	4-68
4-14 Summary of Total CDD/CDF Emissions from Industrial Wood Residue-Fired Boilers .....	4-70
4-15 Total CDD/CDF Emissions from a Wood-Fired Boiler while Burning Bleached Kraft Mill Sludge .....	4-71
4-16 CDD/CDF Emission Factors for Coal-Fired Residential Furnaces .....	4-77
4-17 CDD/CDF Emission Factors for Oil-Fired Residential Furnaces .....	4-78
4-18 Average CDD/CDF Emission Factors for Wood-Fired Residential Combustors .....	4-79
4-19 CDD/CDF Emission Factors from Waste Tire Incineration .....	4-83
4-20 CDD/CDF Emission Factors from a Crematory .....	4-85
4-21 1991 U.S. Crematory Locations by State .....	4-88
4-22 CDD/CDF Emission Factors from a Cupola Furnace .....	4-93
4-23 CDD/CDF Emission Concentrations and Emission Factors for Secondary Copper Smelting - Copper Recovery Cupola Furnace .....	4-100
4-24 CDD/CDF Emission Factors for Secondary Aluminum Shredding and Delacquering System - Scrubber Outlet Control Device - Venturi Scrubber .....	4-108
4-25 CDD/CDF Emission Factors for Secondary Aluminum Shredding and Delacquering System Control Device - Multiple Cyclones .....	4-109
4-26 U.S. Secondary Lead Smelters .....	4-111

LIST OF TABLES, continued

<u>Table</u>	<u>Page</u>
4-27 CDD/CDF Emission Factors for Secondary Lead Smelting . . . . .	4-126
4-28 CDD/CDF Flue Gas Concentrations and Emission Factors for a Scrap Wire and Transformer Incinerator . . . . .	4-131
4-29 CDD/CDF Emission Concentrations and Emission Factors for a Drum and Barrel Reclamation Facility . . . . .	4-134
4-30 Summary of Total CDD/CDF Emissions and Emission Factors from Kraft Recovery Furnaces . . . . .	4-143
4-31 Distribution of Kraft Pulp Mills in the United States (1997) . . . . .	4-144
4-32 Emission Factors for On-Road Mobile Sources . . . . .	4-149
4-33 Types of Equipment Used for Activated Carbon Regeneration . . . . .	4-152
4-34 CDD/CDF Concentrations in the Flue Gas and Ash from a Fluidized-bed Carbon Regeneration Furnace . . . . .	4-156
4-35 CDD/CDF Concentrations and Emission Factors for a Horizontal Infrared Carbon Regeneration Furnace . . . . .	4-157
4-36 CDD/CDF Emissions Data from a Multiple-Hearth Carbon Regeneration Furnace .	4-158
4-37 Carbon Regeneration Furnace Emission Factors . . . . .	4-159
4-38 Estimates of the Number and Type of PCB-Containing Electrical Equipment in the United States (1988) . . . . .	4-167
4-39 Emission Factors from a Landfill Gas Combustion System . . . . .	4-170
4-40 Some Commercial Chlorophenol Products and Derivatives that may be Contaminated with Dioxins or Furans . . . . .	4-175
4-41 Dioxin Contaminants Associated with Chlorobenzenes . . . . .	4-179
4-42 Industrial Brominated Compounds . . . . .	4-181

LIST OF TABLES, continued

<u>Table</u>		<u>Page</u>
4-43	Brominated Compounds with the Potential for BDD/BDF Formation . . . . .	4-183
4-44	CDD/CDF Emission Factors for Dry Process Portland Cement Kilns . . . . .	4-188
4-45	CDD/CDF Emission Factors for Wet Process Portland Cement Kilns . . . . .	4-191
4-46	Summary of Portland Cement Plant Capacity Information . . . . .	4-193
5-1	Comparison of MM5 and SASS Characteristics . . . . .	5-4

## LIST OF FIGURES

<u>Figure</u>	<u>Page</u>
4-1 Typical Mass Burn Waterwall Combustor . . . . .	4-4
4-2 Typical Mass Burn Rotary Waterwall Combustor . . . . .	4-6
4-3 Typical Modular Starved-Air Combustor with Transfer Rams . . . . .	4-9
4-4 Typical Modular Excess-Air Combustor . . . . .	4-10
4-5 Typical RDF-Fired Spreader Stoker Boiler . . . . .	4-12
4-6 Fluidized-Bed Combustor . . . . .	4-15
4-7 Controlled-Air Incinerator . . . . .	4-22
4-8 Excess-Air Incinerator . . . . .	4-24
4-9 Rotary Kiln Incinerator . . . . .	4-27
4-10 Cross Section of a Typical Multiple Hearth Furnace . . . . .	4-35
4-11 Cross Section of an Electric Infrared Furnace . . . . .	4-38
4-12 One-Cell Dutch Oven-Type Boiler . . . . .	4-64
4-13 Schematic Process Flow Diagram for a Dutch Oven Boiler . . . . .	4-65
4-14 Simplified Diagram of a Freestanding Noncatalytic Woodstove . . . . .	4-75
4-15 Process Flow Diagram for a Typical Sand-Cast Iron and Steel Foundry . . . . .	4-89
4-16 Emission Points in a Typical Iron and Steel Foundry . . . . .	4-90
4-17 Secondary Copper Recovery Process Flow Diagram . . . . .	4-96
4-18a Process Diagram for a Typical Secondary Aluminum Processing Industry . . . . .	4-102
4-18b Process for a Typical Secondary Aluminum Processing Industry . . . . .	4-103
4-19 APROS Delacquering and Preheating Process . . . . .	4-105



LIST OF FIGURES, continued

<u>Figure</u>	<u>Page</u>
4-20 Simplified Process Flow Diagram for Secondary Lead Smelting . . . . .	4-113
4-21 Cross-sectional View of a Typical Stationary Reverberatory Furnace . . . . .	4-115
4-22 Cross-section of a Typical Blast Furnace . . . . .	4-118
4-23 Side-view of a Typical Rotary Reverberatory Furnace . . . . .	4-120
4-24 Cross-sectional View of an Electric Furnace for Processing Slag . . . . .	4-123
4-25 Scrap Metal Incinerator Process Flow Diagram . . . . .	4-128
4-26 Drum and Barrel Incinerator Process Flow Diagram . . . . .	4-132
4-27 Typical Kraft Pulping and Recovery Process . . . . .	4-136
4-28 Direct Contact Evaporator Recovery Furnace . . . . .	4-138
4-29 Nondirect Contact Evaporator Recovery Furnace . . . . .	4-139
4-30 Cross-Section of a Typical Multiple-Hearth Furnace . . . . .	4-151
4-31 Process Flow Diagram of Carbon Regeneration Process . . . . .	4-153
4-32 Mechanisms for Halogenated Dioxin and Furan Production . . . . .	4-171
4-33 Dioxin Concentration Versus Temperature . . . . .	4-173
4-34 Schematic Drawing of a Pressure Treating Plant . . . . .	4-178
4-35 Process Diagram of Portland Cement Manufacturing by Dry Process with Preheater . . . . .	4-186
5-1 Modified Method 5 Sampling Train Configuration . . . . .	5-2
5-2 Schematic of a SASS Train . . . . .	5-3

SECTION 1.0  
PURPOSE OF DOCUMENT

The Environmental Protection Agency (EPA) and State and local air pollution control agencies are becoming increasingly aware of the presence of substances in the ambient air that may be toxic at certain concentrations. This awareness has led to attempts to identify source/receptor relationships for these substances and to develop control programs to regulate toxic emissions. Unfortunately, very little information is available on the ambient air concentrations of these substances or on the sources that may be discharging them to the atmosphere.

To assist groups interested in inventorying air emissions of various potentially toxic substances, EPA is preparing a series of documents that compiles available information on sources and emissions. Existing documents in the series are listed below. In addition, new documents currently under development will address lead and lead compounds, and arsenic.

<u>Substance or Source Category</u>	<u>EPA Publication Number</u>
Acrylonitrile	EPA-450/4-84-007a
Benzene (under revision)	EPA-450/4-84-007q
1,3-Butadiene	EPA-454/R-96-008
Cadmium	EPA-454/R-93-040
Carbon Tetrachloride	EPA-450/4-84-007b
Chlorobenzenes (revised)	EPA-454/R-93-044
Chloroform	EPA-450/4-84-007c

<u>Substance or Source Category</u>	<u>EPA Publication Number</u>
Chromium	EPA-450/4-84-007g
Chromium (supplement)	EPA-450/2-89-002
Coal and Oil Combustion Sources	EPA-450/2-89-001
Cyanide Compounds	EPA-454/R-93-041
Epichlorohydrin	EPA-450/4-84-007j
Ethylene Oxide	EPA-450/4-84-007l
Ethylene Dichloride	EPA-450/4-84-007d
Formaldehyde	EPA-450/2-91-012
Manganese	EPA-450/4-84-007h
Medical Waste Incinerators	EPA-454/R-93-053
Mercury and Mercury Compounds	EPA-453/R-93-023
Methyl Chloroform	EPA-454/R-93-045
Methyl Ethyl Ketone	EPA-454/R-93-046
Methylene Chloride	EPA-454/R-93-006
Municipal Waste Combustors	EPA-450/2-89-006
Nickel	EPA-450/4-84-007f
Organic Liquid Storage Tanks	EPA-450/4-88-004
Perchloroethylene and Trichloroethylene	EPA-450/2-90-013
Phosgene	EPA-450/4-84-007i
Polychlorinated Biphenyls (PCB)	EPA-450/4-84-007n
Polycyclic Organic Matter (POM) (under revision)	EPA-450/4-84-007p
Sewage Sludge Incineration	EPA-450/2-90-009
Styrene	EPA-454/R-93-011
Toluene	EPA-454/R-93-047
Vinylidene Chloride	EPA-450/4-84-007k
Xylenes	EPA-454/R-93-048

This document deals specifically with chlorinated dibenzo-p-dioxins (CDD) and chlorinated dibenzofurans (CDF). Its intended audience includes federal, state and local air pollution personnel and others who are interested in locating potential emitters of dioxins and/or furans and in making gross emissions estimates.

The available data on some potential sources of CDD/CDF emissions are limited and the configurations of many sources will not be the same as those described here. Therefore, this document is best used as a primer to inform air pollution personnel about: (1) the types of sources that may emit CDD/CDF, (2) process variations that may be expected within these sources, and (3) available emissions information that indicates the potential for CDD/CDF to be released into the air from each operation.

The reader is strongly cautioned against using the emissions information contained in this document to try to develop an exact assessment of emissions from any particular facility. Available data are insufficient to develop statistical estimates of the accuracy of these emission factors, so no estimate can be made of the error that could result when these factors are used to calculate emissions from any given facility. It is possible, in some cases, that order-of-magnitude differences could result between actual and calculated emissions, depending on differences in source configurations, control equipment, and operating practices. Thus, in situations where an accurate assessment of CDD/CDF emissions is necessary, source-specific information should be obtained to confirm the existence of particular emitting operations, the types and effectiveness of control measures, and the impact of operating practices. A source test should be considered as the best means to determine air emissions directly from a facility or operation.

An effort was made during the development of this report to compare information and data with recently published reports, collectively referred to as the *Dioxin Reassessment Reports* by the Office of Health and Environmental Assessment ([OHEA]; this office is now named the National Center for Environmental Assessment), U.S. Environmental Protection Agency, Washington, DC. The data presented in this document were, for the most part,

developed from the same information sources and are consistent between the two reports as well as with the most recent version of EPA's *Compilation of Air Pollutant Emission Factors* (AP-42).<sup>1</sup>

As standard procedure, L&E documents are sent to government, industry, and environmental groups wherever EPA is aware of expertise. These groups are given the opportunity to review a document, comment, and provide additional data where applicable. Although this document has undergone extensive review, there may still be shortcomings. Comments subsequent to publication are welcome and will be addressed in future revisions and in related products based on available time and resources. In addition, any comments on the contents or usefulness of this document are welcome, as is any information on process descriptions, operating practices, control measures, and emissions information that would enable EPA to update and improve the document's contents. All comments should be sent to:

Dallas Safriet  
Emission Factor and Inventory Group (MD-14)  
Office of Air Quality Planning and Standards  
U. S. Environmental Protection Agency  
Research Triangle Park, North Carolina 27711

## SECTION 2.0 OVERVIEW OF DOCUMENT CONTENTS

As noted in Section 1.0, the purpose of this document is to assist federal, state, and local air pollution agencies and others who are interested in locating potential air emitters of CDD/CDF and making preliminary estimates of air emissions therefrom. Because of the limited background data available, the information summarized in this document does not and should not be assumed to represent the source configuration or emissions associated with any particular facility.

This section provides an overview of the contents of this document. It briefly outlines the nature, extent, and format of the material presented in the remaining sections.

Section 3.0 of this document provides a brief summary of the physical and chemical characteristics of CDD/CDF, their basic formation mechanisms, a brief discussion of toxic equivalency (TEQ) concepts and methodology, and a summary of national CDD/CDF emissions expressed as TEQs.

Section 4.0 focuses on major sources of CDD/CDF air emissions. The following groups of emission sources are presented: waste incineration; combustion of solid and liquid fuels in stationary sources for heat and power generation; crematories; iron and steel foundries; combustion-aided metal recovery; kraft pulp and paper production - black liquor combustion; internal combustion engines; carbon regeneration; open burning and accidental fires; municipal solid waste landfills; organic chemicals manufacture and use; and Portland cement production.

Within each group, there may be several unique but related sources. For each air emission source described in Section 4.0, a discussion of the process, potential emission control techniques, available emission factor information, and source location information are summarized. Because of limited information, emission factors could not be developed for all the air emission sources presented. Further, those emission factors presented vary in their representativeness of the air emission source they describe. Each section should be read carefully to ensure an understanding of the basis for the emission factors presented.

Section 5.0 summarizes available procedures for source sampling and analysis of CDD/CDF. EPA does not prescribe nor endorse any non-EPA sampling or analytical procedure presented in Section 5.0. Consequently, this document merely provides an overview of applicable source sampling procedures, citing references for those interested in conducting source tests. References are listed in Section 6.0.

Appendix A provides a brief description of the basis for the national emission estimates appearing in Section 3.0. For each source, the emission estimation technique is described and an example calculation, if applicable, is included.

Each emission factor listed in Section 4.0 was assigned an emission factor quality rating (A, B, C, D, E, or U) based on the criteria for assigning data quality ratings and emission factor ratings as required in the document *Technical Procedures for Developing AP-42 Emission Factors and Preparing AP-42 Sections*.<sup>2</sup> The criteria for assigning the quality ratings to source test data are as follows:

A - Rated. Test(s) was performed by a sound methodology and reported in enough detail for adequate validation. These tests are not necessarily EPA reference test methods, although such reference methods are certainly to be used as a guide.

B - Rated. Test(s) was performed by a generally sound methodology but lacked enough detail for adequate validation.

C - Rated. Test(s) was based on a nonvalidated or draft methodology or lacked a significant amount of background data.

D - Rated. Test(s) was based on a generally unacceptable method but may provide an order-of-magnitude value for the source.

Once the (data) quality ratings for the source tests had been assigned, these ratings along with the number of source tests available for a given emission point were evaluated. Because of the almost impossible task of assigning a meaningful confidence limit to industry-specific variables (e.g., sample size versus sample population, industry and facility variability, method of measurement), the use of a statistical confidence interval for establishing a representative emission factor for each source category was not practical. Therefore, some subjective quality rating was necessary. The following rating system was used to describe the quality of emission factors in this document.

A - Excellent. The emission factor was developed only from A-rated test data taken from many randomly chosen facilities in the industry population. The source category is specific enough to minimize variability within the source category population.

B - Above average. The emission factor was developed only from A-rated test data from a reasonable number of facilities. Although no specific bias is evident, it is not clear if the facilities tested represent a random sample of the industry. As with the A rating, the source category is specific enough to minimize variability within the source category population.

C - Average. The emission factor was developed only from A- and B-rated test data from a reasonable number of facilities. Although no specific bias is evident, it is not clear if the facilities tested represent a random sample of the industry. As with the A rating, the source category is specific enough to minimize variability within the source category population.

D - Below average. The emission factor was developed only from A- and B-rated test data from a small number of facilities, and there may be reason to suspect that these facilities do not represent a random sample of the industry. There also may be evidence of variability within the source category population.



E - Poor. The emission factor was developed from C- and D-rated test data, and there may be reason to suspect that the facilities tested do not represent a random sample of the industry. There also may be evidence of variability within the source category population.

U - Unrated or Unratable. The emission factor was developed from suspect data with no supporting documentation to accurately apply an A through E rating. A "U" rating may be applied in the following circumstances:<sup>3</sup>

- U1 = Mass Balance (for example, estimating air emissions based on raw material input, product recovery efficiency, and percent control).
- U2 = Source test deficiencies (such as inadequate quality assurance/quality control, questionable source test methods, only one source test).
- U3 = Technology transfer.
- U4 = Engineering judgement.
- U5 = Lack of supporting documentation.

This document does not contain any discussion of health or other environmental effects of CDD/CDF emissions, nor does it include any discussion of ambient air levels of CDD/CDF.

## SECTION 3.0 BACKGROUND

This section discusses the nature of dioxins and furans, their formation mechanisms, and toxic equivalency concepts and methodology. A summary of national emissions levels, expressed as TEQs, is also included in this section.

### 3.1 NATURE OF POLLUTANT

A dioxin is any compound that contains the dibenzo-p-dioxin nucleus. A furan is any compound that contains the dibenzofuran nucleus. The general formulas are shown below:

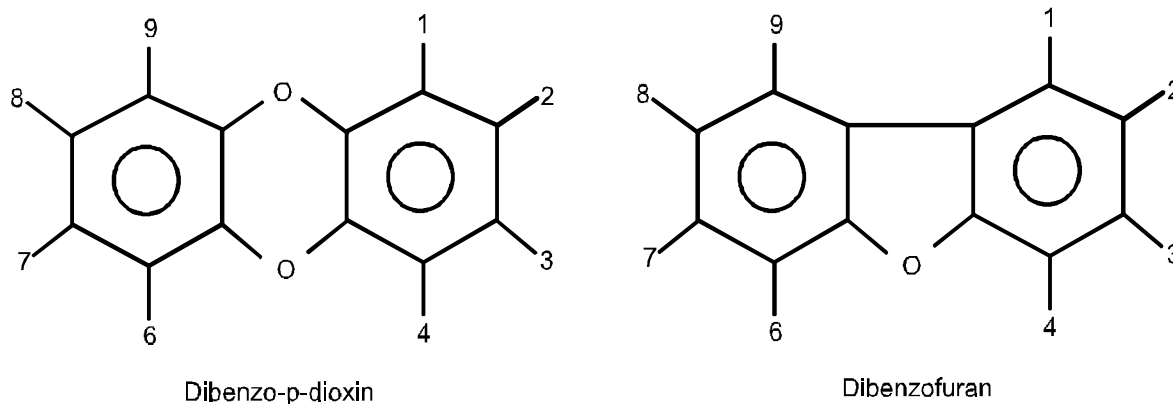

Each of the positions numbered 1 through 4 and 6 through 9 can be substituted with a chlorine or other halogen atom, an organic radical, or, if no other substituent is indicated in the formula or in its chemical name, a hydrogen atom.

The only differences between members within a dioxin or a furan family are in the nature and position of substituents. Most environmental interest is with the chlorinated species of dioxins and furans which have very similar chemical properties.<sup>4</sup>

The term isomers refers to compounds with the same empirical formulas. The term homologues refers to compounds within the same series (e.g., CDD or CDF), but with a different number of chlorine atoms (i.e., tetra-CDD, penta-CDF, etc.). In all, there are 75 possible CDD and 135 possible CDF. The number of possible isomers per number of chlorine atoms is given in Table 3-1.

Throughout this document the various homologues of CDD and CDF are abbreviated as follows:

T	=	tetra
Pe	=	penta
Hx	=	hexa
Hp	=	hepta
O	=	octa

For example, hexa-CDD is abbreviated as HxCDD.

The CDD/CDF represent a series of homologues with volatility decreasing as the number of chlorine atoms incorporated into the molecules increases. Because of the general lack of solubility in water and overall low volatility, the CDD/CDF are far more likely to be found in soil or as condensed on particulate matter than as gaseous pollutants in the air. If the CDD/CDF originate from a stationary source where elevated temperatures are encountered, the members of the series containing four or more chlorine atoms tend to occur mostly as condensable particulate matter, while the more volatile members of the series may exist in the gaseous state, depending upon the exact conditions of temperature and particulate loading.

TABLE 3-1. POSSIBLE CDD AND CDF ISOMERS

Number of Chlorine Atoms	Number of Possible CDD Isomers	Number of Possible CDF Isomers
1	2	4
2	10	16
3	14	28
4	22	38
5	14	28
6	10	16
7	2	4
8	<u>1</u>	<u>1</u>
	75	135

Source: Reference 4.

Table 3-2 lists the chemical and physical properties of some dioxins and furans. As indicated within the table, the physical properties of substituted dibenzofurans have not been well investigated.

CDD are white solids. The most toxic and, consequently, the most extensively studied of the CDD, is 2,3,7,8-tetrachlorodibenzo-p-dioxin (TCDD).<sup>4</sup> This compound is extremely lipophilic, exhibiting a high degree of solubility in fats, oils, and relatively nonpolar solvents. 2,3,7,8-TCDD is only sparingly soluble in water.

Most CDD are rather stable toward heat, acids, and alkalis, although heat treatment with an alkali (under conditions similar to alkaline extraction of tissue) completely destroys OCDD. CDD begin to decompose at about 930°F (500°C), and at about 1470°F (800°C) virtually complete degradation of 2,3,7,8-TCDD occurs within 21 seconds. CDD are susceptible to photodegradation in the presence of ultraviolet light, and undergo photoreductive dechlorination in the presence of an effective hydrogen donor.<sup>6</sup>

TABLE 3-2. PHYSICAL AND CHEMICAL PROPERTIES OF SELECTED DIOXINS AND FURANS

Compound	CAS Reg. No.	Molecular Formula	Molecular Weight	Description	Melting Point (°C)	Boiling Point at 760 mmHg (°C)	Vapor Pressure (mmHg at 25°C)
Dibenzo-p-dioxin	262-12-4	C <sub>12</sub> H <sub>8</sub> O <sub>2</sub>	184.20	NA	122-123	NA	4.125x10 <sup>-4</sup>
2,3,7,8-TCDD	1746-01-6	C <sub>12</sub> H <sub>4</sub> Cl <sub>4</sub> O <sub>2</sub>	321.9	colorless needles	305-306	NA	7.4x10 <sup>-10</sup>
1,2,3,7,8-PeCDD	40321-76-4	C <sub>12</sub> H <sub>3</sub> Cl <sub>5</sub> O <sub>2</sub>	356.5	NA	240-241	NA	NA
1,2,3,6,7,8-HxCDD	57653-85-7	C <sub>12</sub> H <sub>2</sub> Cl <sub>6</sub> O <sub>2</sub>	390.9	NA	285-286	NA	3.6x10 <sup>11</sup>
1,2,3,7,8,9-HxCDD	19408-74-3	C <sub>12</sub> H <sub>2</sub> Cl <sub>6</sub> O <sub>2</sub>	390.9	NA	243-244	NA	NA
OCDD	3268-87-9	C <sub>12</sub> Cl <sub>8</sub> O <sub>2</sub>	459.8	NA	330	NA	NA
Dibenzofuran	132-64-9	C <sub>12</sub> H <sub>8</sub> O	168.2	(1) crystalline solid (2) white crystals (3) leaf or needles from alcohol	86-87	287	4.41x10 <sup>-3</sup>
2,3,7,8-TCDF	51207-31-9	C <sub>12</sub> H <sub>4</sub> Cl <sub>4</sub> O	306.0	NA	226-228	NA	2.0x10 <sup>-6 a</sup>
2,4,6,8-TCDF	NA	C <sub>12</sub> H <sub>4</sub> Cl <sub>4</sub> O	306.0	NA	198-200	NA	2.5x10 <sup>-6 a</sup>
OCDF	39001-02-0	C <sub>12</sub> Cl <sub>8</sub> O	443.8	NA	253-254 <sup>b</sup>	NA	0.19x10 <sup>-6 a</sup>

Source: References 4 and 5

TABLE 3-2. PHYSICAL AND CHEMICAL PROPERTIES OF SELECTED DIOXINS AND FURANS (CONTINUED)

Compound	Vapor Density	Density (g/mL)	$\lambda_{\text{max}}^{\text{c}}$ (chloroform) (nm)	$1/E^{\text{c}}\lambda$	Solubilities	Other Chemical/Physical Properties
Dibenzo-p-dioxin	NA	NA	293	199.8	1 ppm at 25°C	NA
2,3,7,8-TCDD	NA	NA	310	173.6	1.4 g/L in o-dichlorobenzene 0.72 g/L in chlorobenzene 0.57 g/L in benzene 0.37 g/L in chloroform 0.11 g/L in acetone 0.048 g/L in n-Octanol 0.01 g/L in methanol $2 \times 10^{-7}$ g/L in water	TCDD can be formed by pyrolysis at 500°C for 5 hr of sodium alpha-(2,4,5-trichlorophenoxy) propionate
1,2,3,7,8-PeCDD	NA	NA	308	171.4	NA	NA
1,2,3,6,7,8-HxCDD	NA	NA	316	152	NA	NA
1,2,3,7,8,9-HxCDD	NA	NA	317	104	NA	NA
OCDD	NA	NA	NA	NA	1.83 g/L in o-dichlorobenzene 0.56 g/L in chloroform 0.38 g/L in dioxane	NA
Dibenzofuran	5.8	1.0886 (at 99°C)	217 (alcohol)	4.5 (log E)	10 ppm in H <sub>2</sub> O (25°C) Soluble in hot benzene, alcohol, acetone, ether, acetic acid	NA
2,3,7,8-TCDF	NA	NA	257,294,310,323	NA	$4.38 \mu\text{g/L}(\text{H}_2\text{O})^{\text{e}}$	2,3,7,8-TCDF (in trichloromethane soln.) exhibits ultraviolet absorption maxs at 309 and 316 nm
2,4,6,8-TCDF	NA	NA	259,309,316	NA	NA	NA
OCDF	NA	NA	NA	NA	NA	NA

Source: References 4 and 5

<sup>a</sup> Calculated value.

<sup>b</sup> Experimental value.

<sup>c</sup> This is the wavelength of maximum absorption.

<sup>d</sup> This is the absorption coefficient for a 1% chloroform solution of substrate in 1 cm cell at the  $\lambda_{\text{max}}$ . To convert this to the molar absorption coefficient ( $\text{M}^{-1} \text{cm}^{-1}$ ), multiply by one-tenth of the molecular weight.

<sup>e</sup> Estimated value.

NA = Not Available

Dibenzofuran is relatively stable toward alkalis and acids. The pyrolysis of this compound for 1.4 seconds in nitrogen at 0.6 atmosphere and 1536°F (830°C) caused only 4.5 percent decomposition, and no decomposition is observed below 1536°F (830°C).<sup>5</sup> The products of decomposition are toluene, styrene, indene, durene, naphthalene, water, hydrogen, carbon, o-ethylphenol and polyphenyl ether. Alkyl- or halogen-substituted dibenzofurans are expected to be less soluble in water and more soluble in organic solvents than dibenzofuran because these compounds are less polar than dibenzofuran.

### 3.2 FORMATION OF CHLORINATED DIBENZO-p-DIOXINS AND CHLORINATED DIBENZOFURANS

CDD and CDF have no known technical use and are not intentionally produced. They are formed as unwanted byproducts of certain chemical processes during the manufacture of chlorinated intermediates and in the combustion of chlorinated materials.<sup>7</sup> The chlorinated precursors include polychlorinated biphenyls (PCB), polychlorinated phenols, and polyvinyl chloride (PVC).

The manufacture of chlorophenols and the reaction of chlorophenols with chlorobenzenes yield CDD as byproducts. Polyvinyl chloride is known to give a small yield of chlorobenzene on pyrolysis, and chlorobenzenes themselves pyrolyze in the presence of air to yield CDD and CDF. Polychlorinated phenols give CDD at high temperatures, and PCB produce CDF on laboratory pyrolysis in the presence of air.<sup>8</sup> Possible routes of formation of CDD and CDF are illustrated in the diagram on the next page.

In the case of pyrolysis or combustion of chlorinated phenols, the absence of oxygen stimulates the production of CDD, indicating that the yield of CDD is the net result of thermal decomposition of polychlorinated phenols to water, carbon dioxide, etc., and the thermal formation of CDD precursors.<sup>8</sup>

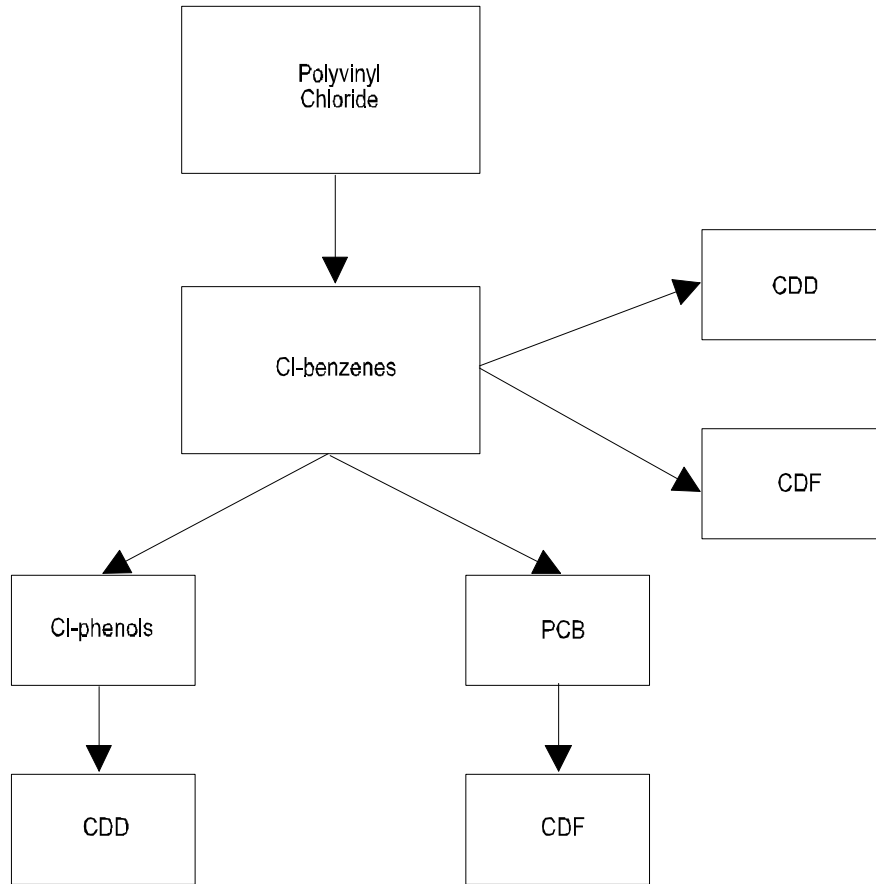

There is no evidence to suggest that dioxins and furans are formed biosynthetically by living organisms.

### 3.2.1 Combustion Factors Affecting Dioxin/Furan Emissions

There are three general mechanisms that can result in emissions of CDD/CDF from combustion systems: (1) incomplete destruction of CDD/CDF present in the fuel source during the combustion process, (2) in-furnace formation of CDD/CDF from "precursor" materials, and (3) low temperature downstream formation in the flue gas ductwork or across the air pollution control device. An overview of the combustion factors affecting CDD/CDF emissions is presented below.



## Incomplete Destruction of CDD/CDF in Fuel

CDD/CDF have been detected in several materials (fuels) during combustion. If the combustion process is inefficient, a portion of the CDD/CDF in these materials can escape from the combustion system and be emitted into the atmosphere. However, the fuel-and-air mixing processes and temperatures in most combustion systems are sufficient to destroy most of the CDD/CDF that may be in the original material. Exceptions to this are structural fires in which CDD/CDF contaminated building materials exist, or small combustors (e.g., wood stoves or fire places) where combustion conditions may be non-ideal. Based on the operating characteristics of most combustion systems and the low levels of CDD/CDF in most materials, emissions of CDD/CDF due to incomplete destruction during combustion are expected to be small compared to the other two mechanisms.

## In-Furnace Formation

In-furnace formation refers to the formation of CDD/CDF during the combustion process. During combustion, various ring-structure hydrocarbon species (referred to as "precursors") are formed as intermediate reaction products. If chlorine is also present, these species can react with each other to form CDD/CDF. The most frequently identified precursors are chlorobenzenes, chlorophenols, and chlorinated biphenyls.<sup>9</sup> CDD/CDF may also be formed from the reaction of complex organic molecules and chlorine. Several studies have identified strong correlations between chlorine content and CDD/CDF emissions during combustion tests.<sup>9</sup>

In-furnace formation of CDD/CDF is also related to combustion practices. CDD/CDF are generally formed in greater quantities during combustion upsets or when mixing of air and combustible hydrocarbon is poor, since higher levels of organics can escape the furnace at these times. Good correlations exist between CO and CDD/CDF when CO emissions are high, as CO generally indicates poor combustion. Insufficient mixing among air, fuel, and combustion products has been identified as an important cause of increased CDD/CDF formation. The

potential for release of CDD/CDF from the combustion chamber is minimized by operating the furnace to achieve low CO levels.<sup>9,10</sup>

### Downstream Formation

Recent studies have shown that CDD/CDF also forms downstream of the furnace in ductwork or in air pollution control devices. Available data indicate that aromatic structures associated with carbon in the fly ash can be converted to CDD/CDF through reactions with inorganic chlorine. This process is referred to as "de novo" synthesis. CDD/CDF are generally formed through de novo synthesis at temperatures ranging from 392°F to 932°F (200°C to 500°C), with maximum formation rates occurring near 572°F (300°C). Several studies have been conducted on CDD/CDF downstream formation in MWCs and are discussed in greater detail in Section 4.1 of this report.

### 3.3 TOXIC EQUIVALENCY CONCEPTS AND METHODOLOGY

The toxicity equivalency factor (TEF) method is an interim procedure for assessing the risks associated with exposures to complex mixtures of CDD/CDF. This method relates the toxicity of the 210 structurally related chemical pollutants (135 CDF and 75 CDD) and is based on limited data available from *in vivo* and *in vitro* toxicity testing. The toxicity of the most highly studied dibenzo-p-dioxin, 2,3,7,8-TCDD, is used as a reference in relating the toxicity of the other 209 compounds (i.e., in terms of equivalent amounts of 2,3,7,8-TCDD). This approach simplifies risk assessments, including assessments of exposure to mixtures of CDD and CDF such as incinerator flyash, hazardous wastes, contaminated soils, and biological media.<sup>11</sup> In 1989, as a result of the active involvement of EPA in an international effort aimed at adopting a common set of TEFs, International TEFs/89, or I-TEFs/89, were implemented.<sup>11</sup> The concepts and methodologies are presented in this document only because some emission factors and national emission totals were found in the literature as TEQs.

A strong structure-activity relationship exists between the chemical structure of a particular CDD/CDF homologue and its ability to elicit a biological/toxic response in various *in vivo* and *in vitro* test systems. Congeners in which the 2,3,7, and 8 lateral positions are occupied with chlorines (the "2,3,7,8-substituted homologues") are much more active than the other homologues (the "non-2,3,7,8-substituted homologues").<sup>11</sup>

Available data on short-term *in vitro* toxicity studies for CDD/CDF are used to supplement the lack of long-term *in vivo* results for these compounds. These toxicity estimates, expressed in terms of toxic equivalents (TEQs), or equivalent amounts of 2,3,7,8-TCDD, are generated by using the TEF to convert the concentration of a given CDD/CDF into an equivalent concentration of 2,3,7,8-TCDD. The I-TEQs/89 are obtained by applying the I-TEFs/89 to the congener-specific data and summing the results. In assigning TEFs, priority is normally given to the results from long-term studies followed by the results from short-term, whole-animal studies. Among the remaining short-term *in vivo* and *in vitro* data, the results of enzyme induction studies take high priority because a good correlation has generally been observed between enzyme induction activity and short-term, whole-animal results.<sup>11</sup>

The I-TEF/89 approach expresses the TEFs as a rounded order of magnitude because, with the exception of the I-TEF/89 for PeCDF, the I-TEFs/89s are only crude approximations of relative toxicities. A value of 0.5 is assigned to 2,3,4,7,8-PeCDF; 1,2,3,7,8-PeCDF is assigned a value of 0.05. This higher value for the 2,3,4,7,8-PeCDF is supported by data from *in vivo* and *in vitro* studies and is the only instance in which the I-TEFs/89s depart from the guiding principle of simplicity in which TEFs are expressed as rounded orders of magnitude. The I-TEF/89 scheme assigns a value of zero to non-2,3,7,8-substituted homologues.

In general, an assessment of the human health risk of a mixture of CDD and CDF using the TEF approach involves the following steps:<sup>11</sup>

1. Analytical determination of the CDD and CDF in the sample.

2. Multiplication of homologue concentrations in the sample by TEFs to express the concentration in terms of 2,3,7,8-TCDD equivalents.
3. Summation of the products in Step 2 to obtain the total 2,3,7,8-TCDD equivalents in the sample.
4. Determination of human exposure to the mixture in question, expressed in terms of 2,3,7,8-TCDD equivalents.
5. Combination of exposure from Step 4 with toxicity information on 2,3,7,8-TCDD (usually carcinogenicity and/or reproductive effects) to estimate risks associated with the mixture.

In cases where the concentrations of homologues are known:

$$\begin{aligned}
 \text{2,3,7,8-TCDD Equivalents} &= \sum (\text{TEF of each 2,3,7,8-CDD/CDF homologue}) \\
 &\quad \times \text{the concentration of the respective homologue} \\
 &+ \sum (\text{TEF of each non-2,3,7,8-CDD/CDF homologue}) \\
 &\quad \times \text{the concentration of the respective homologue}
 \end{aligned}$$

Table 3-3 lists I-TEFs/89s for some CDD and CDF.

### 3.4 OVERVIEW OF EMISSIONS

CDD and CDF are not chemically manufactured but are byproducts of certain chemical processes during the manufacture of chlorinated intermediates and in the combustion of chlorinated materials. Sources of CDD/CDF emissions include waste incineration, stationary fuel combustion, crematories, metal foundries and recovery facilities, kraft pulp and paper production, internal combustion engines, carbon regeneration, biomass burning, organic chemical manufacture, and Portland cement manufacture. These sources of CDD/CDF emissions are described in Section 4.0 of this document.

TABLE 3-3. INTERNATIONAL TOXICITY EQUIVALENCY FACTORS/89  
(I-TEFs/89)

Homologue	I-TEFs/89
2,3,7,8-TCDD	1
1,2,3,7,8-PeCDD	0.5
1,2,3,4,7,8-HxCDD	0.1
1,2,3,7,8,9-HxCDD	0.1
1,2,3,6,7,8-HxCDD	0.1
1,2,3,4,6,7,8-HpCDD	0.01
OCDD	0.001
2,3,7,8-TCDF	0.1
2,3,4,7,8-PeCDF	0.5
1,2,3,7,8-PeCDF	0.05
1,2,3,4,7,8-HxCDF	0.1
1,2,3,6,7,8-HxCDF	0.1
1,2,3,7,8,9-HxCDF	0.1
2,3,4,6,7,8-HxCDF	0.1
1,2,3,4,6,7,8-HpCDF	0.01
1,2,3,4,7,8,9-HpCDF	0.01
OCDF	0.001

Source: Reference 11.

National emission estimates for each category/subcategory were developed using one of two basic approaches. The first, and preferred approach was to utilize emission estimates developed by the Emission Standards Division (ESD)/ Office of Air Quality Planning and Standards (OAQPS) project teams responsible for developing Maximum Achievable Control Technology (MACT) standards, or other EPA projects where in-depth evaluation and characterization of the source categories were conducted (e.g., Secondary Lead Smelting NESHAP Program). The second approach was to use category-specific national activity data (throughput, production, fuel use, etc.), emission factors, and available information on industry characteristics and control levels to develop a national emission estimate. The availability and overall quality of national activity data varies by category. Preferred sources of national activity data are trade associations and statistics compiled by various government entities (the EPA, Department of Energy, Energy Information Administration [EIA]). Emission factors derived from actual source test data were used wherever possible. An attempt was made to utilize emission factors that reflect the standard emission control methods used by each source category. In addition, supplemental information on three source categories was included based on findings in a recent OHEA (now named the National Center for Environmental Assessment) study.

Several national emission estimates were taken from recent studies by the Office of Air Quality Planning and Standards, and some of the results are expressed in units of EPA-TEQs. The EPA adopted the International Methodology in 1989; thus, any data presented as an EPA-TEQ should be equivalent to an International (I)-TEQ value.

Estimates of national CDD/CDF emissions are shown in Tables 3-4 through 3-6. Tables 3-4 through 3-6 present the national emissions of 2,3,7,8-TCDD, 2,3,7,8-TCDF, and 2,3,7,8-TCDD TEQ for each source category, respectively. The source categories are presented in the order of their relative contributions to the total pollutant emissions. Appendix A describes the basis for the estimates. For some source categories discussed in this document, data were not available to estimate national emissions, and are so noted within Tables 3-4 through 3-6 and in Appendix A.

TABLE 3-4. NATIONAL 2,3,7,8-TCDD EMISSIONS<sup>a</sup>

Source Category <sup>b</sup>	2,3,7,8-TCDD Emissions (lb/yr) <sup>c</sup>	Base Year of Estimated <sup>d</sup>
Utility Coal Combustion <sup>e</sup>	2.8x10 <sup>-2</sup>	1990
Secondary Copper Smelters	1.36x10 <sup>-2</sup>	1990
Residential Coal Combustion	1.16x10 <sup>-2</sup>	1990
On-road Mobile Sources	8.06x10 <sup>-3</sup>	1992
Utility Residual Oil Combustion <sup>e</sup>	8.00x10 <sup>-3</sup>	1990
Industrial Wood Combustion	6.65x10 <sup>-3</sup>	1990
Residential Distillate Fuel Combustion	2.82x10 <sup>-3</sup>	1990
Iron and Steel Foundries	2.52x10 <sup>-3</sup>	1990
Secondary Lead Smelters	1.95x10 <sup>-3</sup>	1990
Sewage Sludge Incineration	9.5E x 10 <sup>-4</sup>	1992
Residential Wood Combustion	8.62x10 <sup>-4</sup>	1990
Hazardous Waste Incineration	2.40x10 <sup>-4</sup>	1992
Drum and Barrel	2.12x10 <sup>-5</sup>	1990
Carbon Regeneration /Reactivation	1.51x10 <sup>-5</sup>	1990
Waste Tire Incineration	1.19x10 <sup>-5</sup>	1990
Crematories	1.83x10 <sup>-8</sup>	1991
Forest Fires	NA	
Lightweight Aggregate Kilns	NA	
Medical Waste Incineration	NA	
Municipal Waste Combustion	NA	
Portland Cement: Non-Hazardous	NA	
Portland Cement: Hazardous Waste	NA	
Pulp and Paper- Kraft Recovery	NA	
Secondary Aluminum Smelters	NA	
Wood Treatment	NA	
Industrial Waste Incineration	NA	
Municipal Solid Waste Landfills	NA	
Organic Chemical Manufacturing	NA	
PCB Fires	NA	
Scrap Metal Incineration	NA	
<b>Total</b>	<b>8.53x10<sup>-2</sup></b>	

<sup>a</sup> Estimates presented here are those that were available at the time this document was published. Ongoing efforts and studies by the U.S. EPA will most likely generate new estimates and the reader should contact the Environmental Protection Agency for the most recent estimates.

<sup>b</sup> Source categories are ranked in the order of their contribution to total 2,3,7,8-TCDD emissions.

<sup>c</sup> Emission estimates are in pounds per year. To convert to kilograms per year, multiply by 0.454.

<sup>d</sup> This is the year that the emissions estimate represents.

<sup>e</sup> The value presented for this source category is a draft estimate and has not yet been finalized by the EPA.

NA = Not Available.

TABLE 3-5. NATIONAL 2,3,7,8-TCDF EMISSIONS<sup>a</sup>

Source Category <sup>b</sup>	2,3,7,8-TCDF Emissions (lb/yr) <sup>c</sup>	Base Year of Estimated <sup>d</sup>
Sewage Sludge Incineration	3.42x10 <sup>-1</sup>	1992
Residential Coal Combustion	3.05x10 <sup>-1</sup>	1990
On-road Mobile Sources	1.27x10 <sup>-1</sup>	1992
Iron and Steel Foundries	8.08x10 <sup>-2</sup>	1990
Utility Coal Combustion <sup>e</sup>	6.80x10 <sup>-2</sup>	1990
Residential Wood Combustion	3.01x10 <sup>-2</sup>	1990
Hazardous Waste Incineration	2.73x10 <sup>-2</sup>	1992
Secondary Lead Smelters	1.20x10 <sup>-2</sup>	1990
Industrial Wood Combustion	9.51x10 <sup>-3</sup>	1990
Utility Residual Oil Combustion <sup>e</sup>	5.80x10 <sup>-3</sup>	1990
Residential Distillate Fuel Combustion	2.68x10 <sup>-3</sup>	1990
Drum and Barrel Reclamation/Incineration	3.70x10 <sup>-4</sup>	1990
Carbon Regeneration /Reactivation	9.78x10 <sup>-5</sup>	1990
Waste Tire Incineration	2.98x10 <sup>-5</sup>	1990
Crematories	1.33x10 <sup>-7</sup>	1991
Forest Fires	NA	
Lightweight Aggregate Kilns (Hazardous)	NA	
Medical Waste Incineration	NA	
Municipal Waste Combustion	NA	
Portland Cement: Hazardous Waste Fired	NA	
Portland Cement: Non-Hazardous Waste	NA	
Pulp and Paper- Kraft Recovery Furnaces	NA	
Secondary Aluminum Smelters	NA	
Secondary Copper Smelters	NA	
Wood Treatment	NA	
Industrial Waste Incineration	NA	
Municipal Solid Waste Landfills	NA	
Organic Chemical Manufacturing	NA	
PCB Fires	NA	
Scrap Metal Incineration	NA	
<b>Total</b>	<b>1.01</b>	

<sup>a</sup> Estimates presented here are those that were available at the time this document was published. Ongoing efforts and studies by the U.S. EPA will most likely generate new estimates and the reader should contact the Environmental Protection Agency for the most recent estimates.

<sup>b</sup> Source categories are ranked in the order of their contribution to total 2,3,7,8-TCDF emissions.

<sup>c</sup> Emission estimates are in pounds per year. To convert to kilograms per year, multiply by 0.454.

<sup>d</sup> This is the year that the emissions estimate represents.

<sup>e</sup> The value presented for this source category is a draft estimate and has not yet been finalized by the EPA.

NA = Not Available.



TABLE 3-6. NATIONAL 2,3,7,8-TCDD TEQ EMISSIONS<sup>a</sup>

Source Category <sup>b</sup>	2,3,7,8-TCDD TEQ Emissions (lb/yr) <sup>c</sup>	Base Year of Estimated <sup>d</sup>
Municipal Waste Combustion	1.61	1995
Residential Coal Combustion	4.68x10 <sup>-1</sup>	1990
Secondary Aluminum Smelters	3.8x10 <sup>-1</sup>	1990
Medical Waste Incineration	3.32x10 <sup>-1</sup>	1995
Utility Coal Combustion <sup>e</sup>	3.0x10 <sup>-1</sup>	1990
Industrial Wood Combustion	2.25x10 <sup>-1</sup>	1990
On-road Mobile Sources	1.98x10 <sup>-1</sup>	1992
Forst Fires	1.90x10 <sup>-1</sup>	1989
Portland Cement: Hazardous Waste Fired	1.3x10 <sup>-1</sup>	1996
Portland Cement: Non-Hazardous Waste	1.2x10 <sup>-1</sup>	1990
Wood Treatment	7.62x10 <sup>-2</sup>	1988
Residential Wood Combustion	6.76x10 <sup>-2</sup>	1990
Sewage Sludge Incineration	5.29x10 <sup>-2</sup>	1992
Hazardous Waste Incineration	4.9x10 <sup>-2</sup>	1992
Iron and Steel Foundries	3.75x10 <sup>-2</sup>	1990
Utility Residual Oil Combustion <sup>e</sup>	2.2x10 <sup>-2</sup>	1990
Secondary Copper Smelters	1.36x10 <sup>-2</sup>	1990
Secondary Lead Smelters-fired)	8.49x10 <sup>-3</sup>	1990
Residential Distillate Fuel Combustion	7.57x10 <sup>-3</sup>	1990
Lightweight Aggregate Kilns (Hazardous	6.92x10 <sup>-3</sup>	1996
Pulp and Paper-Kraft Recovery Furnaces	6.84x10 <sup>-4</sup>	1990
Waste Tire Incineration Recovery Furnaces	5.94x10 <sup>-4</sup>	1990
Drum and Barrel Reclamation/Incineration	5.01x10 <sup>-4</sup>	1990
Carbon Regeneration/Reactivation	2.49x10 <sup>-4</sup>	1990
Crematories	NA	
Industrial Waste Incineration	NA	
Municipal Solid Waste Landfills	NA	
Organic Chemical Manufacturing	NA	
PCB Fires	NA	
Scrap Metal Incineration	NA	
<b>Total</b>	<b>4.30</b>	

<sup>a</sup> Estimates presented here are those that were available at the time this document was published. Ongoing efforts and studies by the U.S. EPA will most likely generate new estimates and the reader should contact the Environmental Protection Agency for the most recent estimates.

<sup>b</sup> Source categories are ranked in the order of their contribution to total 2,3,7,8-TCDD TEQ emissions.

<sup>c</sup> Emission estimates are in pounds per year. To convert to kilograms per year, multiply by 0.454.

<sup>d</sup> This is the year that the emissions estimate represents.

<sup>e</sup> The value presented for this source category is a draft estimate and has not yet been finalized by the EPA.

NA = Not Available.

It should also be noted that estimates for some source categories were available for 2,3,7,8-TCDD TEQ only (see Tables 3-4, 3-5, and 3-6) due to the limited amount of information (such as activity data or an emission factor in non-TEQ units) available at the time this document was prepared.

For the municipal waste combustion and medical waste incineration categories, results from recent EPA MACT standard development studies are presented. The new estimates identify a baseline dioxin level for estimated dioxin emissions for 1995. The new estimates for these categories are based on an extensive database and are considered by EPA to be the most accurate estimates available at this time.<sup>12,13</sup>

EPA's Office of Research and Development (ORD) has received emissions data for on-road mobile sources that are more current than the data presented in this document and is in the process of developing emission factors from the data. When ORD completes their evaluation of the data, the emission factors will be publicly available.

## SECTION 4.0

### EMISSIONS SOURCES

Sources of atmospheric emissions of CDD/CDF are described in this section. Many of the source categories discussed in this section emit CDD/CDF from a fuel combustion process. Process descriptions and flow diagrams are included in the discussions as appropriate. Emission factors for the processes are presented when available, and control technologies and source locations are described.

There are few emission control techniques that are dedicated solely to reducing CDD/CDF emissions, and therefore data on the effectiveness of control strategies in reducing CDD/CDF emissions are limited. In many cases, the emission factor data available are for both controlled and uncontrolled processes and/or units, and are presented within this section, where available.

#### 4.1 WASTE INCINERATION

This section discusses CDD/CDF emissions from waste incineration. Types of waste incineration that are potential sources of CDD/CDF emissions include (1) municipal waste combustion, (2) medical waste incineration, (3) sewage sludge incineration, (4) hazardous waste incineration, and (5) industrial waste incineration. The following sections provide descriptions of these processes and present associated emission factors.

#### 4.1.1 Municipal Waste Combustion

Municipal wastes are combusted primarily to reduce waste volume before disposal. Municipal waste combustion is used as an alternative to landfilling; heat energy recovery may also be associated with the process. The wastes burned in municipal waste combustors (MWCs) come primarily from residential sources; however, in some areas, commercial and industrial sources contribute significant quantities to the total waste load.<sup>14</sup>

There are approximately 160 MWC facilities with capacities greater than 35 megagrams per day (Mg/day) [39 tons per day (tpd)].<sup>15</sup> Smaller facilities serve specialized needs such as prisons and remote communities where conditions are unsuitable for landfills. This section focuses on MWCs with capacities greater than or equal to 35 Mg/day (39 tpd) of municipal solid waste (MSW) because this population represents the majority of MWC facilities in the United States. Also, emission information on the smaller facilities is limited.

##### Process Descriptions

The majority of MWCs can be grouped under three main design types: mass burn, modular, and refuse-derived fuel (RDF)-fired. Some MWCs fire only RDF, but RDF may also be co-fired with other fuels. A fourth type of MWC, fluidized-bed, is less common and can be considered a subset of the RDF technology. Within the three major combustor categories, there are a number of different designs. The more common designs and their associated processes are described in this section.

Mass Burn Combustors--Mass burn combustors use gravity or mechanical ram systems to feed MSW onto a moving grate where the waste is combusted. Historically, mass burn combustors have been used to combust MSW that has not been preprocessed except to remove items too large to go through the feed system. Waste that has been processed to remove

recyclable materials can also be combusted in these units. Mass burn combustors range in size from 46 to 900 Mg/day (50 to 1000 tpd) and are assembled in the field.<sup>16</sup>

Mass burn combustors can be divided into mass burn/waterwall (MB/WW), mass burn rotary waterwall combustors (MB/RC), and mass burn/refractory-wall (MB/REF) designs. Newer units are mainly waterwall designs, which are used to recover heat for production of steam and/or electricity.

*Mass Burn Waterwall Combustors:* A typical MB/WW combustor is shown in Figure 4-1. Waste is delivered by an overhead crane to a feed hopper, which feeds the waste into the combustion chamber. Most modern MB/WW facilities have reciprocating or roller grates that move the waste through the combustion chamber. The primary purpose of all types of grates is to agitate the waste bed to ensure good mixing of the waste with undergrate air and to move the waste uniformly through the combustor.

Combustion air is added to the waste from beneath each grate section through underfire air plenums. As the waste bed burns, overfire air is introduced through rows of high-pressure nozzles located in the side walls of the combustor to oxidize hydrocarbon-rich gases and complete the combustion process. Properly designed and operated overfire air systems are essential for good mixing and burnout of organics in the flue gas.

The combustor walls are constructed of metal tubes that contain pressurized water and recover radiant heat from the combustion chamber. Flue gases exiting the combustor pass through additional heat recovery sections (i.e., superheater, economizer) and are then routed to one or more air pollution control devices such as an electrostatic precipitator (ESP).

Typically, MB/WW MWCs are operated with 80 to 100 percent excess air, with 25 to 40 percent of the total air supplied as overfire air and 60 to 75 percent as underfire air.

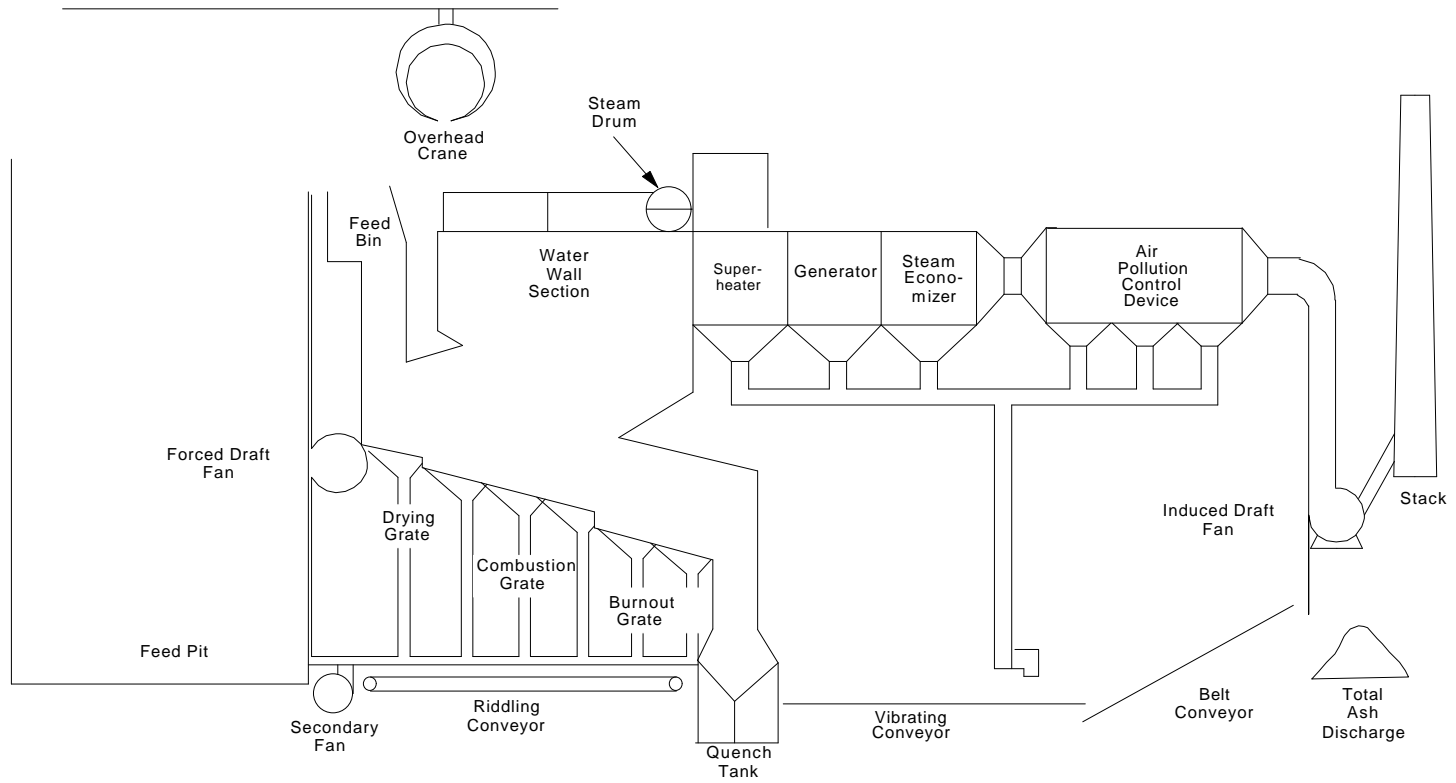

Figure 4-1. Typical Mass Burn Waterwall Combustor

Source: Reference 16.

*Mass Burn Rotary Waterwall Combustor:* Figure 4-2 shows a typical MB/RC combustor. Waste is conveyed to a feed chute and fed to the rotary combustion chamber. The rotary combustion chamber sits at a slight angle and rotates at about 10 revolutions per hour, causing the waste to advance and tumble as it burns. The combustion cylinder consists of alternating watertubes and perforated steel plates.<sup>17</sup>

Preheated combustion air enters the combustor through the perforated plates. As the combustor cylinder rotates, combustion air is introduced both through and above the waste bed. Combustion air is also supplied to the afterburning grate and through the overfire air jets located above the rotary combustor outlet in the boiler chamber. An MB/RC combustor normally operates at about 50 percent excess air.

Heat recovery occurs in the rotary chamber water tubes, the boiler waterwall, the superheater, and in the economizer. From the economizer, the flue gas is routed to one or more air pollution control devices.

*Mass Burn Refractory-Wall Combustors:* Numerous MB/REF combustors were in operation prior to 1970.<sup>16</sup> The goal of these units was to achieve waste reduction; energy recovery mechanisms were generally not incorporated into their design. By today's standards, these units were frequently poorly designed and operated and, as a result, had significant emissions of particulate matter (PM) and other pollutants. Because of environmental restrictions imposed on large combustion devices by the EPA in the early 1970s, most MB/REF facilities closed. Most of the approximately 25 MB/REF plants that still operate or that were built in the 1970s and 1980s have installed ESPs to reduce PM emissions, and several have installed heat recovery boilers.<sup>17</sup>

MB/REF combustors have several designs. One design involves a batch-fed upright combustor that may be cylindrical or rectangular in shape.

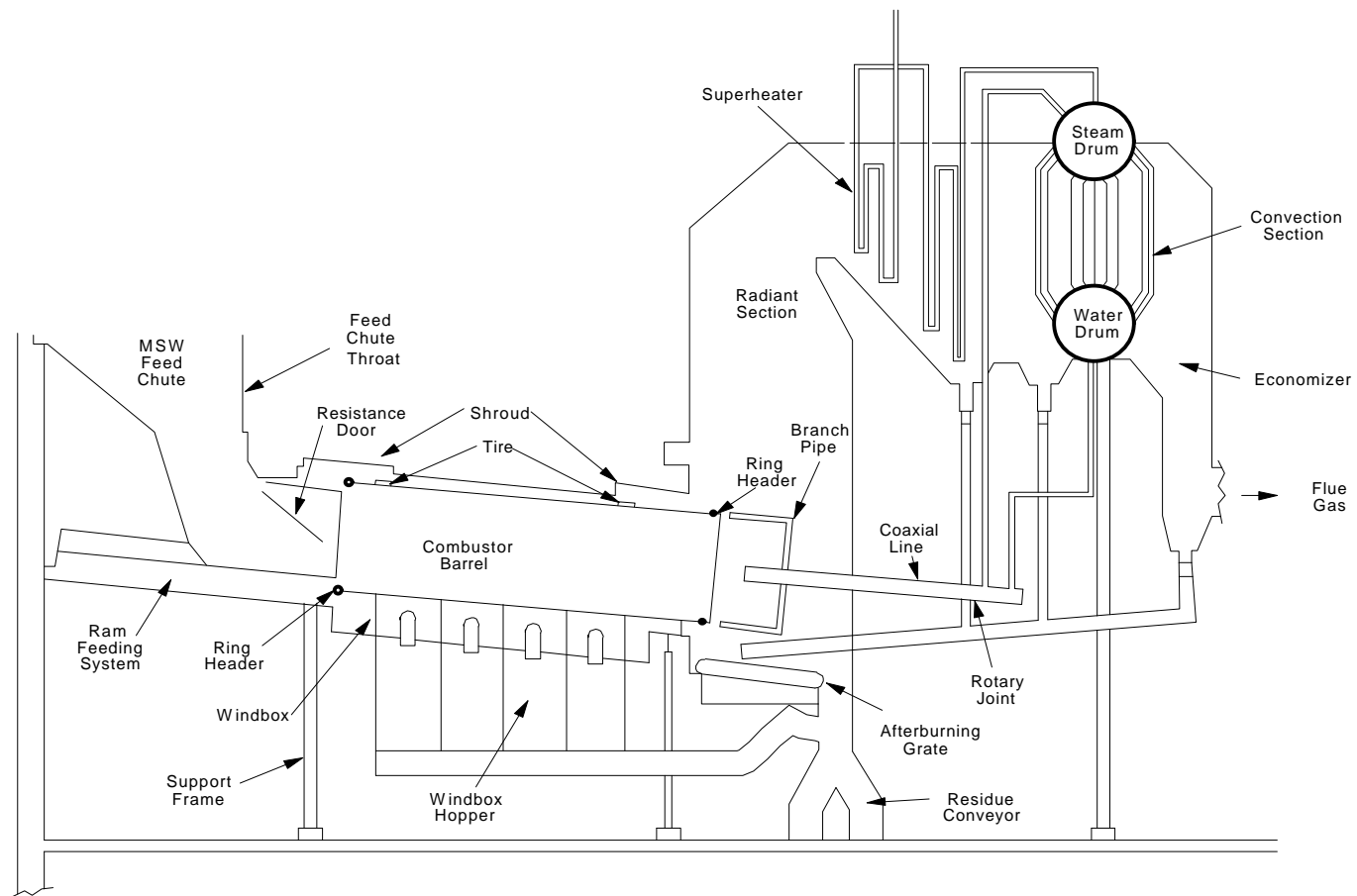

Figure 4-2. Typical Mass Burn Rotary Waterwall Combustor

Source: Reference 16.



This design does not provide for agitation or mixing of the waste. This type of combustor was prevalent in the 1950s, but only three units were reported to be in operation in 1989.<sup>17</sup>

A second, more common design consists of rectangular combustion chambers with traveling, rocking, or reciprocating grates. The traveling grate moves on a set of sprockets and provides agitation to the waste bed as it advances through the combustor. Waste burnout is inhibited by fuel-bed thickness and there is considerable potential for unburned waste to be discharged into the bottom ash pit unless fuel feeding, grate speeds, and combustion air flows and distributions are well controlled. Some designs incorporate rocking or reciprocating grates that agitate and aerate the waste bed as it advances through the combustor chamber, thereby improving contact between the waste and combustion air and increasing the burnout of combustibles. A rotary kiln may be added to the end of the grate system to complete combustion.

MB/REF combustors typically operate at higher excess air rates than do MB/WW combustors. This is because MB/REF combustors do not contain a heat transfer medium such as the waterwalls, thus requiring high excess air levels to prevent excessive temperatures and damage to the combustor.

One adverse effect of higher excess air levels is the potential for increased carryover of PM from the combustion chamber and, therefore, increased stack emission rates. It is hypothesized that high PM carryover may also contribute to increased CDD/CDF emissions by providing increased surface area for downstream catalytic formation. Also, there is a potential for higher excess air levels to quench the combustion reactions, thus reducing destruction of organic species.

Modular Combustors--Modular combustors are similar to mass burn combustors in that the waste burned has not been preprocessed, but modular combustors are generally smaller in size (4.5 to 103 Mg/day [5 to 140 tpd]) and are shop-fabricated. The most common type of modular combustor is the starved-air or controlled-air type (MOD/SA). Another type, which is

similar from a combustion standpoint to the larger MB/WW systems, is referred to as an excess-air combustor (MOD/EA).

*Modular Starved-Air Combustors:* A typical MOD/SA combustor is shown in Figure 4-3. The basic design includes two separate combustion chambers, referred to as the primary and secondary chambers. Waste is batch-fed to the primary chamber by a hydraulically activated ram and is moved through the chamber by either hydraulic transfer rams or reciprocating grates. Waste retention times in the primary chamber are long, lasting up to 12 hours.

Combustion air is introduced into the primary chamber at substoichiometric levels, corresponding to about 40 to 60 percent theoretical air and resulting in a flue gas rich in unburned hydrocarbons. As the hot, hydrocarbon-rich gases flow to the secondary combustion chamber, they mix with excess air to complete the burning process. Additional combustion air is introduced as secondary air and results in excess air levels for the complete system of 80 to 150 percent.

The walls of both the primary and secondary combustion chambers are refractory-lined. Early MOD/SA combustors did not include heat recovery, but a waste heat boiler is common in newer units, with two or more combustion modules sometimes manifolded to a shared boiler.

The high combustion temperatures and mixing of flue gas with additional air in the secondary combustion chamber provide good combustion, resulting in relatively low organic emissions. Because of the limited amount of combustion air introduced through the primary chamber, gas velocities in the primary chamber and the amount of entrained particulate are low. Thus, uncontrolled PM emissions from MOD/SA units are relatively low. As a result, many existing MOD/SA, especially the smaller ones, do not have air pollution controls.

*Modular Excess-Air Combustors:* A typical MOD/EA MWC is shown in Figure 4-4. The basic design is similar to that of MOD/SA units and includes refractory-lined

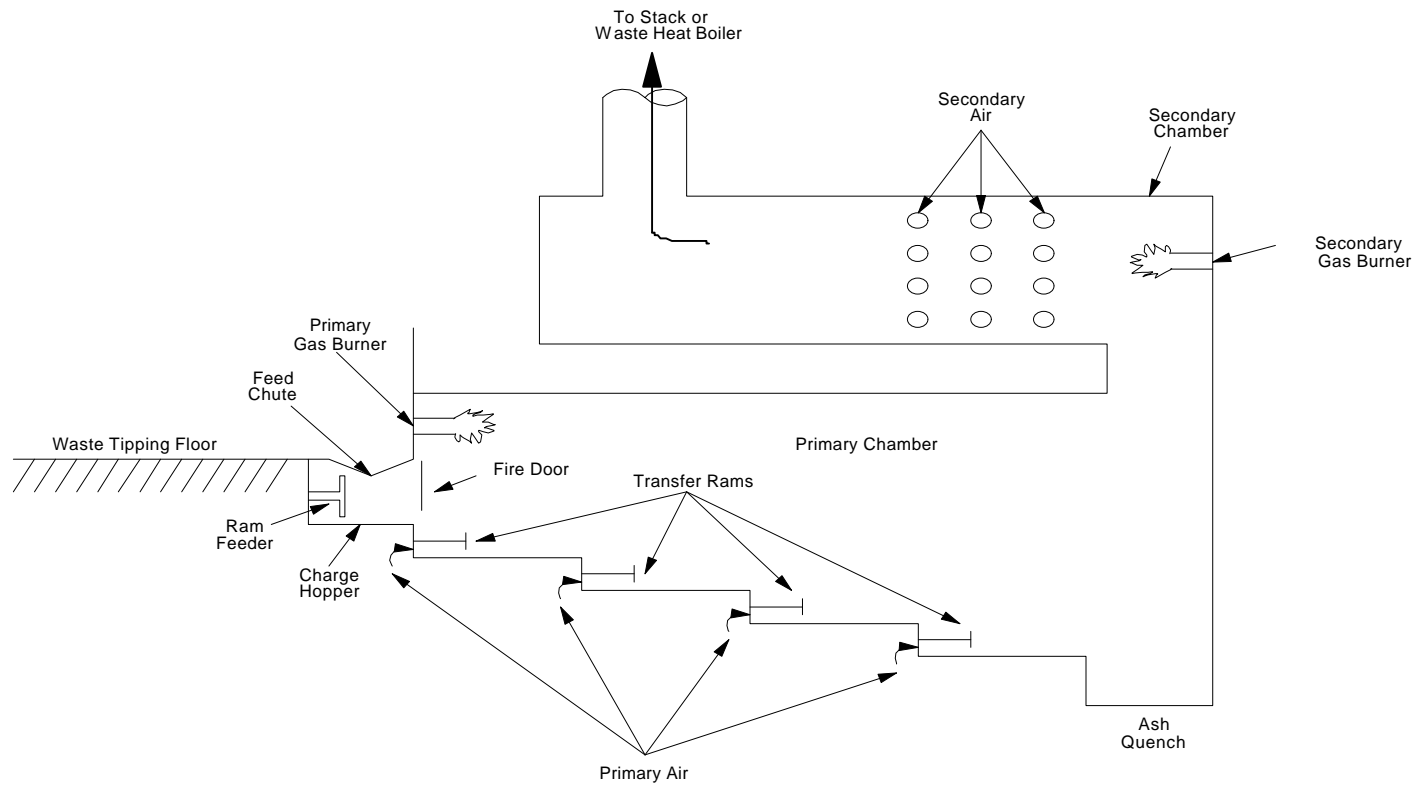

Figure 4-3. Typical Modular Starved-Air Combustor with Transfer Rams

Source: Reference 16.

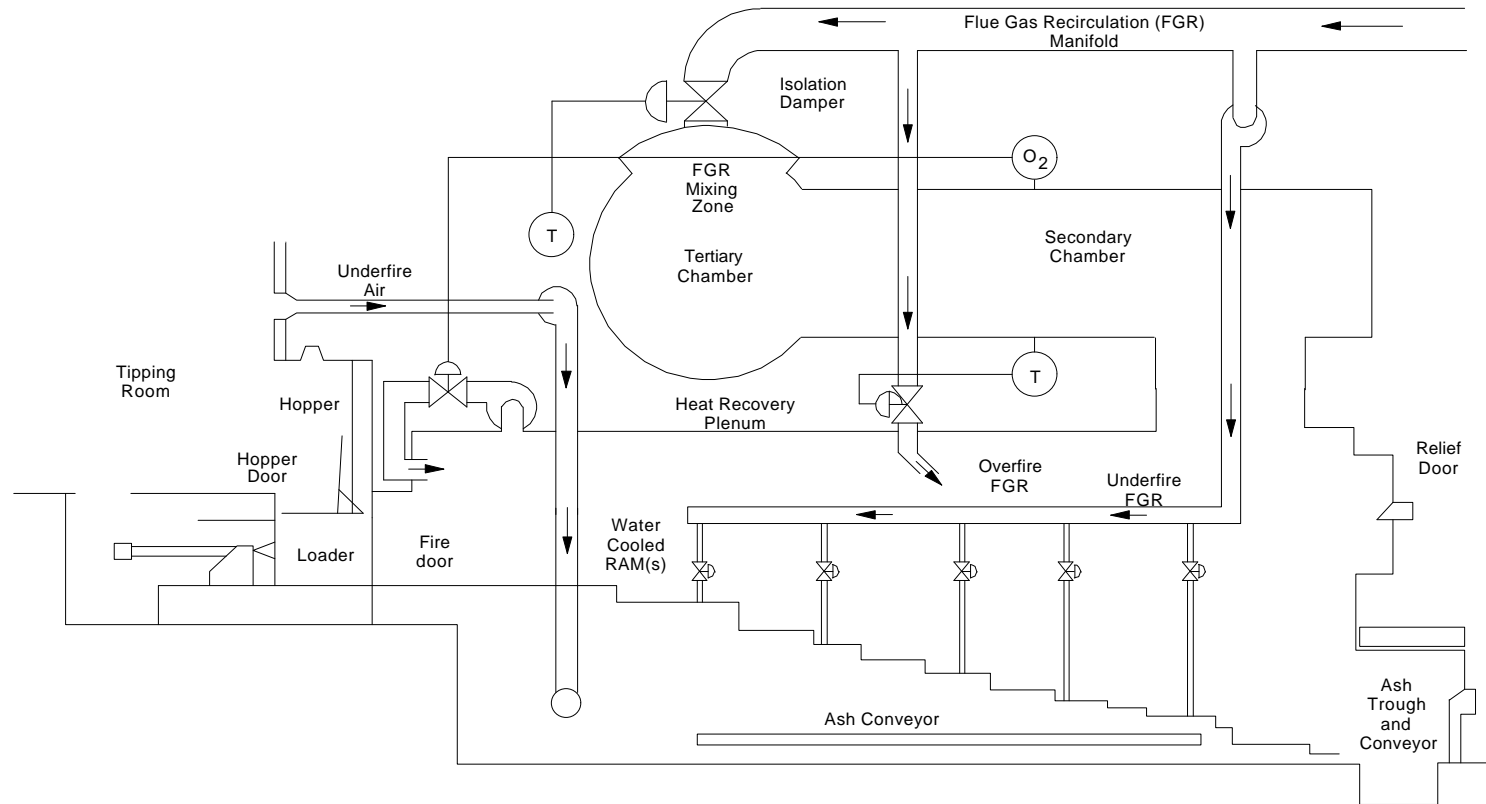

Figure 4-4. Typical Modular Excess-Air Combustor

Source: Reference 16.

primary and secondary combustion chambers and a boiler to recover waste heat. Facilities with multiple combustors may have a tertiary chamber where flue gases from each combustor are mixed prior to entering the heat recovery boiler.

Unlike MOD/SA combustors, MOD/EA combustors typically operate at about 100 percent excess air in the primary chamber, but may vary between 50 and 250 percent excess air. MOD/EA combustors also use recirculated flue gas for combustion air to maintain desired temperatures in the combustion chambers. Because of higher air velocities, PM emissions from MOD/EA combustors are higher than those from MOD/SA combustors.

*Refuse-Derived Fuel-Fired Combustors:* RDF is MSW that has been processed to varying degrees, from simple removal of bulky and noncombustible items accompanied by shredding, to extensive processing to produce a finely divided fuel suitable for co-firing in pulverized coal-fired boilers. Processing MSW to RDF generally raises the heating value of the waste slightly because many of the noncombustible items have been removed.

Individual RDF combustors range from about 290 to 1,270 Mg/day (320 to 1,400 tpd) and they are field-erected.<sup>16</sup> There are three major types of RDF-fired combustors: dedicated RDF combustors, coal/RDF co-fired combustors, and fluidized-bed combustors (FBCs). Each type is discussed in the following paragraphs.

*Dedicated Refuse-Derived Fuel-Fired Combustors:* Most combustors that are designed to burn RDF as a primary fuel are boilers that use spreader-stokers and fire RDF in a semisuspension mode. A typical RDF spreader-stoker boiler is shown in Figure 4-5. RDF is fed into the combustor through a feed chute using air-swept distributors, which allows a portion of the feed to burn in suspension and the remainder to burn out after falling on a horizontal

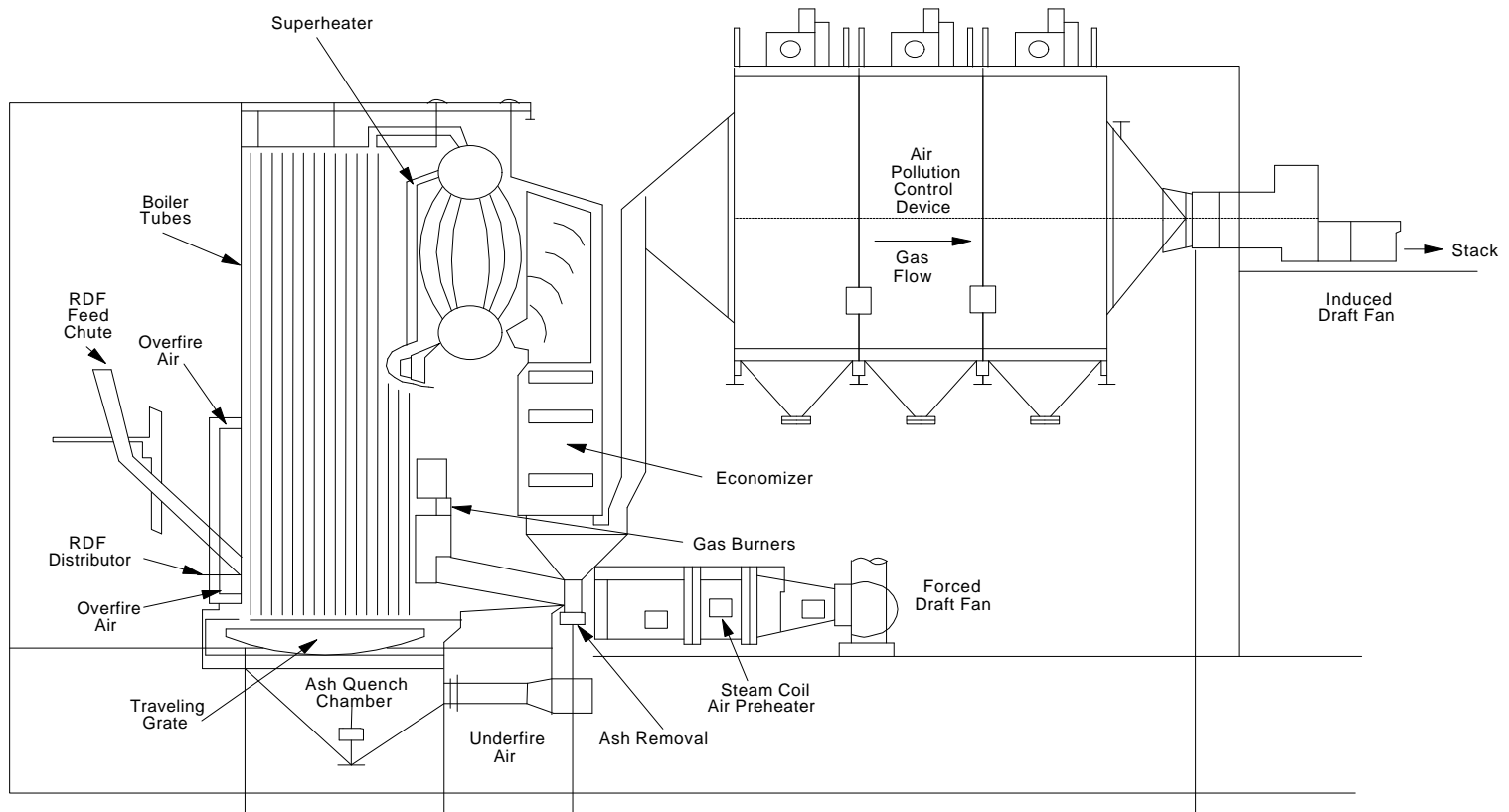

Figure 4-5. Typical RDF-Fired Spreader Stoker Boiler

Source: Reference 16.

traveling grate. The traveling grate moves from the rear to the front of the furnace and distributor settings are adjusted so that most of the waste lands on the rear two-thirds of the grate. This allows more time for combustion to be completed on the grate. Underfire air and overfire air are introduced to enhance combustion, and these combustors typically operate at 80 to 100 percent excess air. Waterwall tubes, a superheater, and an economizer are used to recover heat for production of steam and/or electricity.

*Co-fired Combustors:* RDF can be co-fired in various types of coal-fired boilers, including pulverized coal-fired and cyclone-fired boilers. In a pulverized coal-fired system, coal is pulverized into a powder and injected into the combustor through burners located on the combustor walls. RDF with a particle size of 5 cm (2 in.) or less in diameter is introduced into the combustor by air transport injectors that are located above or even with the coal injectors. A significant portion of the larger, partially burned particles become disengaged from the gas flow and fall onto grates at the bottom of the furnace where combustion is completed. Most RDF/pulverized coal-fired units operate with 50 percent excess air, in contrast to units firing coal alone, which may use as little as 25 percent excess air. Furnace exit temperatures are generally in excess of 1,095 °C (2,000 °F), which is higher than in other MWCs.<sup>16</sup>

In an RDF/coal-fired, cyclone-fired combustor, crushed coal is injected into one end of a horizontal combustion cylinder. Primary air (about 20 percent of the total combustion air) is introduced tangentially to the burner, which causes the coal to move in a swirling pattern. The RDF is injected into the combustion chamber along with the secondary air in the same tangential direction through ports in the top of the cylinder. The cyclone operates at temperatures exceeding 1,370 °C (2,500 °F), which melts the coal and RDF ash into a liquid slag. Because of the swirling motion, most of the incoming coal and RDF gets caught in the slag layer on the combustor walls, where it burns rapidly.

*Fluidized-Bed Combustors:* In an FBC, waste is combusted in a turbulent bed of noncombustible material such as limestone, sand, silica, or aluminum. The RDF may be injected into or above the bed through ports in the combustor wall. Other wastes and supplemental fuel may be blended with the RDF outside the combustor or added through separate openings. The combustion bed is suspended or "fluidized" through the introduction of underfire air at a high flow rate. Overfire air is used to complete the combustion process. Waste-fired FBCs typically operate at 30 to 100 percent excess air levels and at bed temperatures around 815°C (1,500°F). A typical FBC is presented in Figure 4-6.

### Emission Control Techniques

Emissions of CDD/CDF and other organics from MWCs are most effectively controlled first by following good combustion practices (GCP) and, secondly by proper operation of an effective air pollution control system. GCP minimizes in-furnace dioxin generation, minimizes PM carryover, and minimizes low-temperature secondary formation of CDD/CDF. Minimizing in-furnace generation of CDD/CDF is accomplished by optimizing waste feeding procedures, achieving adequate combustion temperatures, providing the proper amount and distribution of combustion air, and optimizing the mixing process. Following these practices will promote complete combustion of the waste and destruction of CDD/CDF and other organics.

Organics, including CDD/CDF, can exist in the vapor phase or can be condensed or absorbed onto fine particulate and exist as PM; therefore, minimization of PM carryover from the combustion chamber into the flue gas can result in a decrease in CDD/CDF emissions. PM carryover can be minimized by maintaining appropriate operating load, combustion air flow rates, and air distributions. For a given combustor design, total air flows are directly related to operating load because each combustor is designed to maintain a relatively constant excess air level. As operating load increases above design limits, air flows increase proportionally and the potential for PM entrainment and carryover increases. Therefore, a limit on maximum operating load can assist in minimizing CDD/CDF emissions.<sup>17</sup>



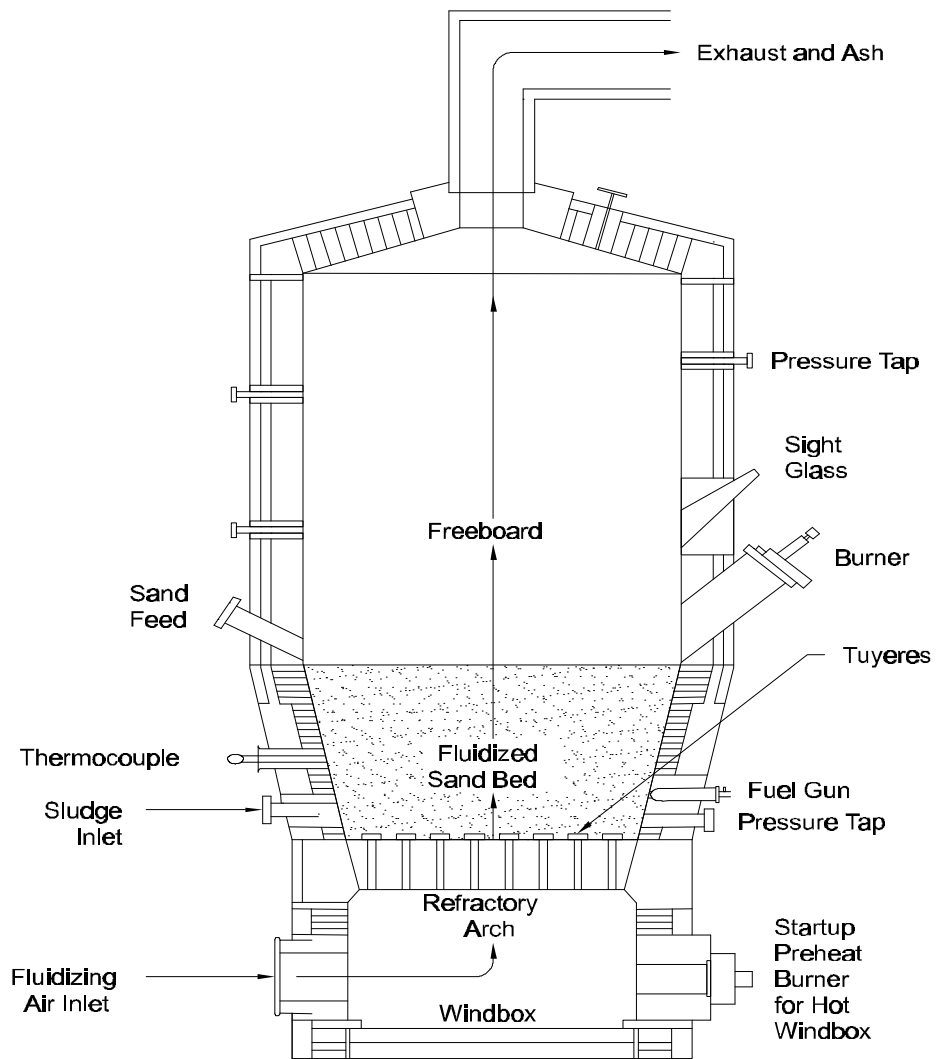

Figure 4-6. Fluidized-Bed Combustor

Source: Reference 18.

Secondary CDD/CDF formation downstream from the furnace can occur in PM control devices (e.g., ESPs). CDD/CDF formation can occur in the presence of excess oxygen over a wide range of temperatures, with maximum formation rates occurring near 570°F (300°C).<sup>17</sup> At temperatures above 570°F, thermal degradation of CDD/CDF can occur. At lower temperatures, the rate of CDD/CDF formation decreases. At PM control device temperatures of 300 to 570°F (150 to 300°C), CDD/CDF concentrations vary by approximately a factor of two for each 86°F (30°C) change in temperature (e.g., reducing the operating temperature of the PM control device from 356°F (180°C) to 302°F (150°C) will reduce CDD/CDF emissions by a factor of approximately two. To reduce emissions of CDD/CDF, the maximum inlet temperature on the PM control device should be reduced to the lowest practical operating temperature, typically below 450°F (e.g., by using a spray dryer or water sprays in combination with the PM control device).<sup>17</sup>

Most MWCs constructed since the late 1980s have a spray dryer installed upstream of the PM control device to control acid gas emissions. The PM control device operating temperature of these systems is typically 275 to 302°F (135 to 150°C). On some MWCs, duct sorbent injection (DSI) is used rather than a spray dryer. Depending on design and operating practices, the flue gas temperature entering the PM control device can be as low as 248°F (120°C) or as high as 392°F (200°C). Because of the wide variation in the PM control device temperature of DSI systems, CDD/CDF emission factors can vary significantly.

Based on recent testing programs, the EPA has found that additional CDD/CDF control is achieved by injecting activated carbon into the flue gas. For example, during EPA tests at a commercial MWC, activated carbon injection achieved significant more CDD/CDF removal than the reduction level achieved by a spray dryer/ESP scrubbing system alone.<sup>19</sup>

## Emission Factors

The emission factors presented in Table 4-1 were developed from a compilation of data published on 107 separate test reports. Emission factors for uncontrolled and controlled levels of operation based on various APCDs are included. For some types of units and APCDs, there is a large amount of data available, while other categories have little data. The reader should refer to the EPA Background Information Documents (BIDs) developed for the NSPS, which provide detailed analyses of specific unit performances capabilities, APCDs, and emissions levels.

The user of these emission factors should recognize that the values reported here are averages and may not be representative of a particular facility. Emissions from MWCs may vary significantly due to the composition of the waste, the extent of GCP, APCD operating temperatures, and various other factors.

It is apparent from the data in Table 4-1 that CDD/CDF emissions vary greatly between combustor types. Emissions variability is attributable to widely differing waste compositions being combusted, combustor operating practices, and control device effectiveness.

## Source Locations

Of the 160 MWCs with capacities greater than 36 Mg/day (40 tpd) in operation in the United States, 53 percent are mass burn, 31 percent are modular, and 15 percent are RDF. Of the total MWC capacity in the United States (101,000 Mg/day [111,400 tpd]), about 69 percent is in mass burn facilities, 26 percent in RDF facilities, and 5 percent in modular facilities.<sup>20</sup>

Table 4-2 presents the geographic distribution of facilities and their capacities.

TABLE 4-1. AVERAGE CDD/CDF EMISSION FACTORS FOR MUNICIPAL WASTE COMBUSTORS<sup>a</sup>

Combustor Type	SCC	Control Device <sup>b</sup>	lb/ton Refuse Combusted	kg/Mg Refuse Combusted	Factor Quality Rating	Reference
Mass Burn Waterwall	5-01-001-05/ 5-03-001-12	Uncontrolled	1.7x10 <sup>-6</sup>	8.4x10 <sup>-7</sup>	A	16
	5-01-001-05/ 5-03-001-12	Electrostatic Precipitator	1.2x10 <sup>-6</sup>	5.8x10 <sup>-7</sup>	A	16
	5-01-001-05/ 5-03-001-12	Spray Dryer/Electrostatic Precipitator	6.2x10 <sup>-7</sup>	3.1x10 <sup>-7</sup>	A	16
	5-01-001-05/ 5-03-001-12	Duct Sorbent Injection/Fabric Filter <sup>c</sup>	1.6x10 <sup>-7</sup>	8.0x10 <sup>-8</sup>	C	16
	5-01-001-05/ 5-03-001-12	Spray Dryer/Fabric Filter	6.6x10 <sup>-8</sup>	3.3x10 <sup>-8</sup>	A	16
	5-03-001-12	Duct Sorbent Injection/Electrostatic Precipitator	4.8x10 <sup>-7</sup>	2.4x10 <sup>-7</sup>	E	12
Mass Burn/Rotary Waterwall	5-01-001-06/ 5-03-001-13	Duct Sorbent Injection/Fabric Filter <sup>c</sup>	9.2x10 <sup>-8</sup>	4.6x10 <sup>-8</sup>	D	16
	5-01-001-06/ 5-03-001-13	Spray Dryer/Fabric Filter	5.3x10 <sup>-8</sup>	2.7x10 <sup>-8</sup>	B	16
Mass Burn/Refractory Wall	5-01-001-04/ 5-03-001-11	Uncontrolled	1.5x10 <sup>-5</sup>	7.5x10 <sup>-6</sup>	D	16
	5-01-001-04/ 5-03-001-11	Electrostatic Precipitator	7.2x10 <sup>-5</sup>	3.6x10 <sup>-5</sup>	D	16
	5-01-001-04/ 5-03-001-11	Duct Sorbent Injection/Electrostatic Precipitator <sup>c</sup>	4.6x10 <sup>-7</sup>	2.3x10 <sup>-7</sup>	E	16

TABLE 4-1. AVERAGE CDD/CDF EMISSION FACTORS FOR MUNICIPAL WASTE COMBUSTORS<sup>a</sup> (CONTINUED)

Combustor Type	SCC	Control Device <sup>b</sup>	lb/ton Refuse Combusted	kg/Mg Refuse Combusted	Factor Quality Rating	Reference
Modular/Excess Air	5-01-001-07/5-03-001-15	Electrostatic Precipitator	2.2x10 <sup>-6</sup>	1.1x10 <sup>-6</sup>	C	16
	5-01-001-07/5-03-001-15	Duct Sorbent Injection/Fabric Filter <sup>c</sup>	6.2x10 <sup>-8</sup>	3.1x10 <sup>-8</sup>	E	16
RDF-fired	5-01-001-03	Uncontrolled	9.5x10 <sup>-6</sup>	4.7x10 <sup>-6</sup>	D	16
		Electrostatic Precipitator	1.7x10 <sup>-5</sup>	8.5x10 <sup>-6</sup>	B	16
		Spray Dryer/Electrostatic Precipitator	1.1x10 <sup>-7</sup>	5.3x10 <sup>-8</sup>	D	16
		Spray Dryer/Fabric Filter	2.4x10 <sup>-8</sup>	1.2x10 <sup>-8</sup>	E	16
		Duct Sorbent Injection/Electrostatic Precipitator	1.3x10 <sup>-6</sup>	6.7x10 <sup>-7</sup>	E	12
RDF-fired/Fluidized Bed	5-01-001-08	Duct Sorbent Injection/Electrified Gravel Bed	6.2x10 <sup>-7</sup>	3.1x10 <sup>-7</sup>	E	12
Modular Starved Air	5-01-001-01/5-03-001-14	Uncontrolled	2.9x10 <sup>-6</sup>	1.5x10 <sup>-6</sup>	D	16
	5-01-001-01/5-03-001-14	Electrostatic Precipitator	3.8x10 <sup>-6</sup>	1.9x10 <sup>-6</sup>	C	16
	5-03-001-14	Duct Sorbent Injection/Fabric Filter	6.5x10 <sup>-8</sup>	3.2x10 <sup>-8</sup>	E	12

<sup>a</sup> Emission factors represent total TCDD/TCDF through OCDD/OCDF emissions.

<sup>b</sup> Uncontrolled = emissions measured at inlet to control device.

<sup>c</sup> Emission factors for duct sorbent injection systems are based on test data for systems with PM control device operating temperatures of approximately 390°F (200°C) for mass burn/waterwall, 375°F (190°C) for mass burn/RC, 300°F (150°C) for mass burn/refractory wall, and 250°F (120°C) for modular/excess air. Emission factors can be adjusted by a factor of two for each 86°F (30°C) change in actual temperature (adjusted EF = reported EF x 2<sup>ΔT/30</sup>, where ΔT is the temperature difference in °C between the actual PM control device temperature and the temperature upon which the reported EF is based).

TABLE 4-2. SUMMARY OF GEOGRAPHICAL DISTRIBUTION OF MWC FACILITIES

State	Number of Facilities	State MWC Capacity (tpd)	Percentage of Total MWC Capacity in the United States
AK	2	170	<1
AL	2	990	1
AR	5	380	<1
CA	3	2,560	2
CT	9	6,663	6
DC	1	1,000	1
DE	1	600	<1
FL	14	17,346	16
GA	1	500	<1
HI	1	2,760	2
IA	1	200	<1
ID	1	50	<1
IN	1	2,362	2
IL	1	1,600	1
MA	10	10,340	9
MD	3	3,810	3
ME	4	1,870	2
MI	5	4,825	4
MN	13	5,332	5
MO	1	78	<1
MS	1	150	<1
MT	1	72	<1
NC	4	775	1
NH	4	856	1
NJ	6	5,822	5
NY	15	12,509	11
OH	4	4,800	4
OK	2	1,230	1
OR	3	813	1
PA	6	7,202	6
PR	1	1,040	1
SC	2	840	1
TN	4	1,480	1
TX	4	244	<1
UT	1	400	<1
VA	9	6,841	6
WA	5	1,498	1
WI	9	1,362	1
Total	160	111,370	

Source: Reference 20.

#### 4.1.2 Medical Waste Incineration

Medical waste incineration is the burning of medical wastes produced by hospitals or similar facilities such as veterinary facilities, and research facilities. Medical wastes include both infectious wastes and non-infectious, or housekeeping wastes.

The primary purposes of medical waste incinerators (MWIs) are to render the waste innocuous and to reduce the volume and mass of the waste. These objectives are accomplished by: (1) exposing the waste to high temperatures over a sufficiently long period of time to destroy threatening organisms; and (2) burning the combustible portion of the waste. The disadvantages of incinerating medical wastes include the generation of ash requiring disposal and the potential release of air toxic emissions.<sup>21</sup>

Medical waste composition, like municipal solid waste, is highly variable. The composition of medical waste is approximately 55 percent paper, 30 percent plastics, and 10 percent water.<sup>21</sup>

##### Process Descriptions

There are three major types of medical waste incinerators: (1) controlled-air, also known as starved-air, (2) excess-air, and (3) rotary kiln. The majority of MWIs in use in the United States are controlled-air, with excess-air incinerators and rotary kilns comprising a small percentage.<sup>22</sup>

Controlled-Air Incinerators--Controlled-air incineration has become the most widely used MWI technology in recent years, and it now dominates the market for new systems at hospitals and similar medical facilities. This technology is also known as starved-air incineration, two-stage incineration, and modular combustion. Figure 4-7 presents a typical controlled-air incinerator.

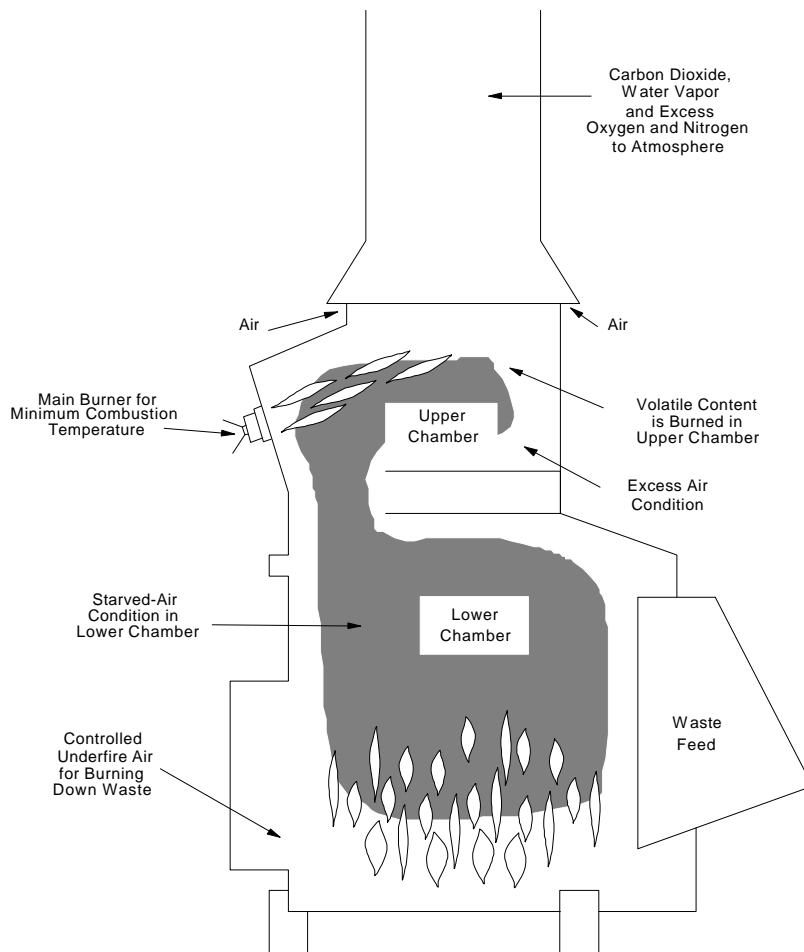

Figure 4-7. Controlled-Air Incinerator

Source: Reference 21.



Combustion of waste in controlled-air incinerators occurs in two stages. In the first stage, waste is fed into the lower primary combustion chamber, which is operated at substoichiometric levels of air combustion--hence the name controlled-air. Combustion air is introduced into the primary chamber beneath the incinerator hearth and below the burning bed of waste. This air is referred to as the primary or underfire air. In the primary chamber, the moisture content of the waste is reduced and the volatile components of the waste are vaporized. Because of the low air addition rates in the primary chamber and the correspondingly low flue gas velocities and turbulence levels, the amount of solids (PM) entrained in the gases leaving the primary chamber is minimized. Temperatures in the primary chamber are relatively low because of the low air-to-fuel ratio, usually ranging from 1,400 to 1,800°F (760 to 985°C).<sup>22</sup>

The hot gases flow to the upper secondary chamber (second stage), where excess combustion air is added to incinerate the volatile compounds. Temperatures in the secondary chamber may range from 1,800 to 2,000°F (985 to 1,095°C). Optimization of controlled-air incinerators requires thorough mixing of the gases in the secondary chamber and prolonging residence time in order to maximize incineration of the wastes. The primary and secondary chambers may be equipped with auxiliary burners to handle wastes with high moisture content or to assist in burnout during start-up or shut-down.<sup>22</sup>

Excess-Air Incinerators--Excess-air incinerators are typically small modular units and are referred to as batch incinerators, multiple-chamber incinerators, or retort incinerators. Excess-air incinerators typically appear to be a compact cube from the outside and have a series of chambers and baffles on the inside. Although they can be operated continuously, they are usually operated in a batch mode. Figure 4-8 presents a typical excess-air incinerator.

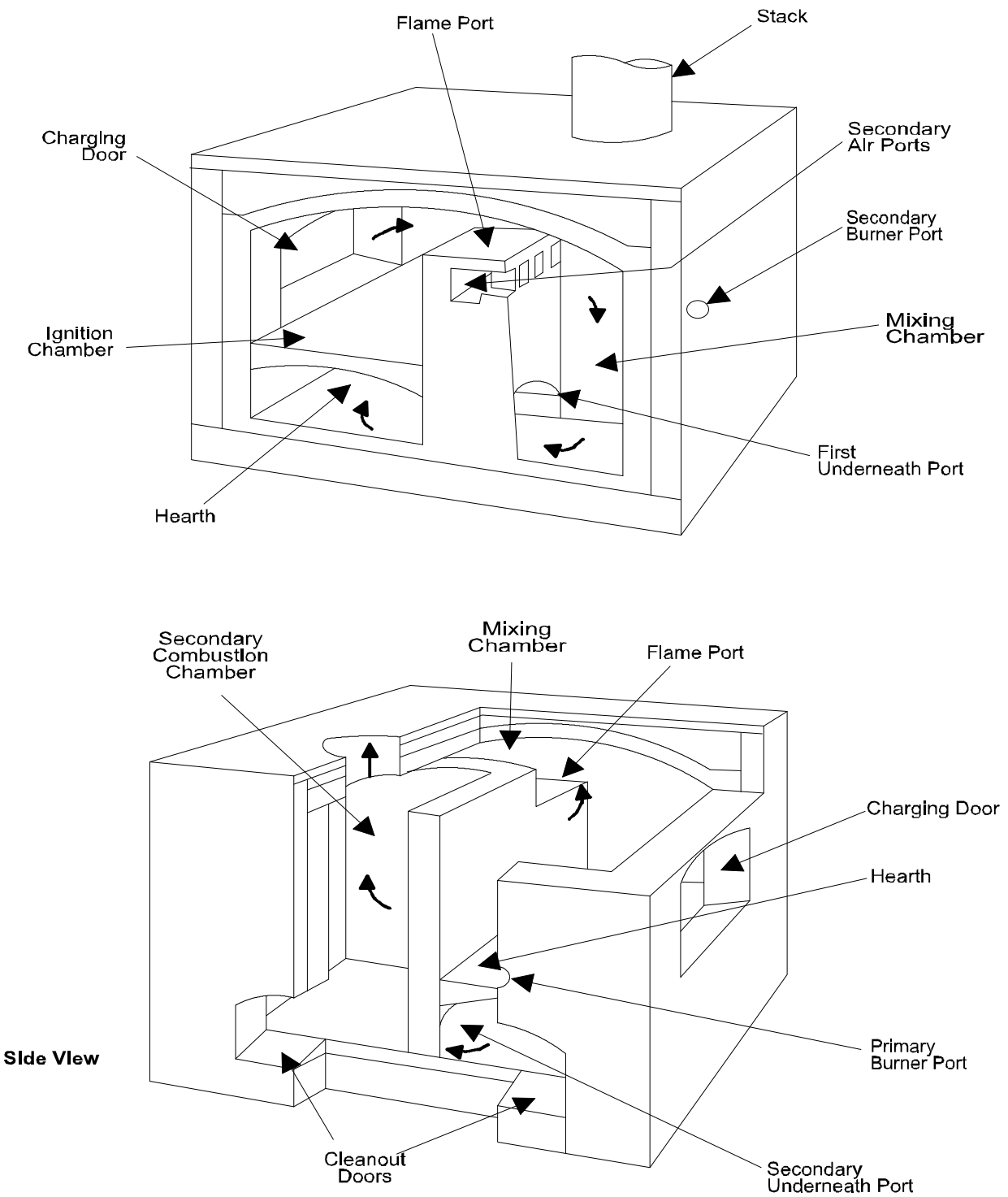

Figure 4-8. Excess-Air Incinerator

Source: Reference 22.

As with controlled-air incinerators, incineration of waste in excess-air incinerators occurs in two stages. Waste is fed through a door into the primary combustion chamber. The charging door is then closed and an afterburner is ignited to bring the secondary combustion chamber to a target temperature, typically 1,600 to 1,800°F (870 to 985°C). When the target temperature is reached, the primary burner is ignited. The moisture in the waste is reduced and the waste is incinerated by heat from the primary chamber burner as well as by radiant heat from the chamber walls.<sup>22</sup>

Volatile components in the waste are vaporized, and the hot gases flow out of the primary chamber through a flame port that connects the primary chamber to the secondary, or mixing, chamber. Secondary combustion air is added through the flame port and is mixed with the volatile components in the secondary chamber. Burners are fitted to the secondary chamber to maintain adequate temperatures for combustion of the volatile gases. The gases exiting the secondary chamber are directed to the incinerator stack or to an air pollution control device (APCD).

When the waste is consumed, the primary burner shuts off. Typically, the afterburner shuts off after a set time. After the primary chamber cools down, the ash is removed from the chamber floor and a new charge of waste can be added.

Excess-air incinerators designed to burn general hospital waste operate at total combustion air levels of up to 300 percent. When only pathological wastes (animal and human remains) are burned, excess air levels near 100 percent are more common. The level of excess-air controls the secondary chamber temperature. Optimization of excess-air incinerators involves maintaining high temperatures with afterburners and prolonging residence times of the gases in the secondary chamber.

Rotary Kiln Incinerators--A typical rotary kiln incinerator is presented in Figure 4-9. Rotary kiln incinerators, like the incinerator types already presented, are designed with a primary chamber where waste is heated and volatilized and a secondary chamber where combustion is completed. The primary chamber consists of a horizontal, rotating kiln that is slightly inclined to allow the waste material to migrate from the feed end to the ash discharge end as the kiln rotates. The waste feed rate is controlled by regulating the rate of rotation and the incline angle of the kiln.

Combustion air enters the primary chamber through a port. An auxiliary burner is usually used to initiate combustion and to maintain desired combustion temperatures. The rotating motion of the kiln stirs the waste and increases the solids burnout rate; however, it also increases the amount of PM entrained in the flue gases.

Volatiles and combustion gases pass from the primary chamber to the secondary chamber, where combustion is completed. The secondary chamber is operated at below excess-air levels and at temperatures as high as 2,400°F (1,315°C).<sup>22</sup>

#### Emission Control Techniques

As with other waste incinerators, emissions of CDD/CDF and other organics from medical waste incinerators are most effectively controlled by following good combustion practices (GCP) and by collection of PM in an APCD. GCP is defined as the combustor system design, operating, and maintenance techniques that, when applied with appropriate flue gas cleaning techniques, can minimize emissions. Examples of GCP for a municipal waste combustor are optimizing waste feeding procedures to avoid combustion instabilities and providing adequate combustion temperatures to ensure destruction of gas-phase organics.

Organics, including CDD/CDF, can exist in the vapor phase or can be condensed or absorbed onto fine particulate; therefore, control of PM emissions can result in a decrease in CDD/CDF emissions. Control devices for PM emissions from medical waste incinerators include

4-27

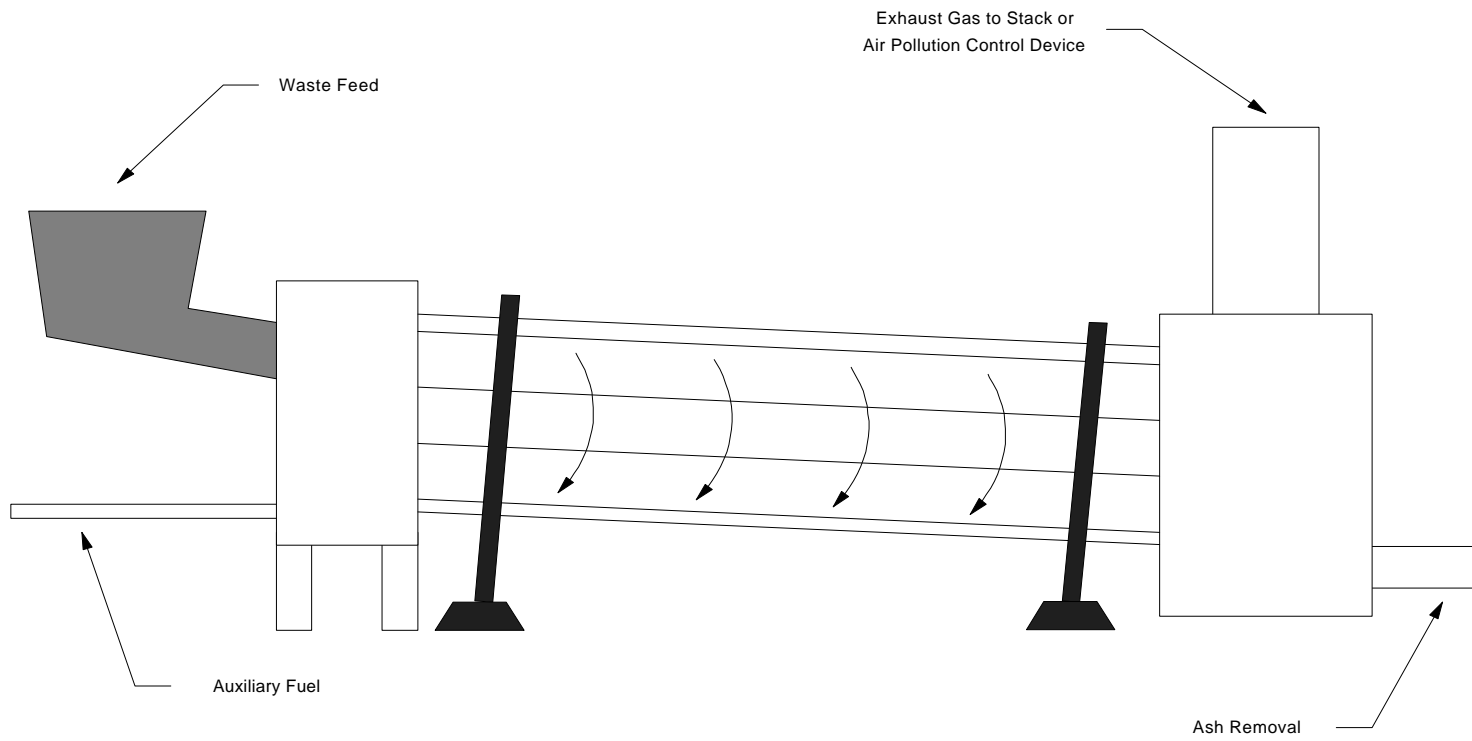

Figure 4-9. Rotary Kiln Incinerator

Source: Reference 22.

ESPs, baghouses or fabric filters, and wet scrubbers. Of these devices, the most frequently used are wet scrubbers and fabric filters.<sup>22</sup>

Based on recent studies, the EPA has found that additional CDD/CDF control is achieved by injecting activated carbon into the flue gas (as with MWCs). Adsorbed CDD/CDF are removed from the carbon bed by heating to a sufficiently high temperature or by reducing the pressure to a sufficiently low value. Typically, the adsorption capacity of activated carbon increases as the molecular weight of the adsorbate increases. Also, unsaturated compounds and cyclic compounds are generally more completely adsorbed than either saturated compounds or linear compounds. CDD/CDF have low vapor pressures and are more easily adsorbed than compounds with higher vapor pressures.

#### Emission Factors

Tables 4-3 through 4-5 present emission factors for CDD and CDF from controlled-air incinerators and rotary kilns by control device type. Emission factors for the 2,3,7,8-TCDD and 2,3,7,8-TCDF isomers and TCDD/TCDF through OCDD/OCDF homologues are provided.

#### Source Locations

The total number of medical waste incinerators in the United States is uncertain. A major segment of the incinerator population is in the thousands of hospitals operating in the United States. It has been estimated that about 40 to 60 percent of hospitals have an incinerator of some type on site.<sup>23</sup> Of the various types of medical waste incinerators in use, the majority (>95 percent) are controlled-air (or starved-air) units, less than 2 percent are excess-air units, and less than 1 percent are rotary kiln units.<sup>21</sup>

TABLE 4-3. CDD EMISSION FACTORS FOR CONTROLLED-AIR MEDICAL WASTE INCINERATORS

SCC 5-01-005-05, 5-02-005-05

Isomer	Uncontrolled			Fabric Filter			Wet Scrubber		
	lb/ton	kg/Mg	Factor Quality Rating	lb/ton	kg/Mg	Factor Quality Rating	lb/ton	kg/Mg	Factor Quality Rating
TCDD									
2,3,7,8-	5.47x10 <sup>-8</sup>	2.73x10 <sup>-8</sup>	E	6.72x10 <sup>-9</sup>	3.36x10 <sup>-9</sup>	E	1.29x10 <sup>-10</sup>	6.45x10 <sup>-11</sup>	E
Total TCDD	1.00x10 <sup>-6</sup>	5.01x10 <sup>-7</sup>	B	1.23x10 <sup>-7</sup>	6.17x10 <sup>-8</sup>	E	2.67x10 <sup>-8</sup>	1.34x10 <sup>-8</sup>	E
PeCDD									
1,2,3,7,8-							6.08x10 <sup>-10</sup>	3.04x10 <sup>-10</sup>	E
Total PeCDD							5.53x10 <sup>-10</sup>	2.77x10 <sup>-10</sup>	E
HxCDD									
1,2,3,6,7,8-	3.78x10 <sup>-10</sup>	1.89x10 <sup>-10</sup>	E				1.84x10 <sup>-9</sup>	9.05x10 <sup>-10</sup>	E
1,2,3,7,8,9-	1.21x10 <sup>-9</sup>	6.07x10 <sup>-10</sup>	E				2.28x10 <sup>-9</sup>	1.14x10 <sup>-9</sup>	E
1,2,3,4,7,8-							9.22x10 <sup>-10</sup>	4.61x10 <sup>-10</sup>	E
Total HxCDD							5.77x10 <sup>-10</sup>	2.89x10 <sup>-10</sup>	E
HpCDD									
1,2,3,4,6,7,8-	5.23x10 <sup>-9</sup>	2.62x10 <sup>-9</sup>	E				6.94x10 <sup>-9</sup>	3.47x10 <sup>-9</sup>	E
Total HpCDD							1.98x10 <sup>-9</sup>	9.91x10 <sup>-10</sup>	E
Total OCDD	2.21x10 <sup>-8</sup>	1.11x10 <sup>-8</sup>	E						
Total CDD	2.13x10 <sup>-5</sup>	1.07x10 <sup>-5</sup>	B	2.68x10 <sup>-6</sup>	1.34x10 <sup>-6</sup>	E	1.84x10 <sup>-6</sup>	9.18x10 <sup>-7</sup>	E

4-29

TABLE 4-3. CDD EMISSION FACTORS FOR CONTROLLED-AIR MEDICAL WASTE INCINERATORS (CONTINUED)

Isomer	DSI/FF			DSI/Carbon Injection/FF			DSI/ESP		
	lb/ton	kg/Mg	Factor Quality Rating	lb/ton	kg/Mg	Factor Quality Rating	lb/ton	kg/Mg	Factor Quality Rating
TCDD									
2,3,7,8-	5.61x10 <sup>-10</sup>	2.81x10 <sup>-10</sup>	E	8.23x10 <sup>-10</sup>	4.11x10 <sup>-10</sup>	E	1.73x10 <sup>-10</sup>	8.65x10 <sup>-11</sup>	E
Total TCDD	6.50x10 <sup>-9</sup>	3.25x10 <sup>-9</sup>	E						
Total CDD	3.44x10 <sup>-7</sup>	1.72x10 <sup>-7</sup>	E	5.38x10 <sup>-8</sup>	2.69x10 <sup>-8</sup>	E			

Source: Reference 22.

DSI = Dry Sorbent Injection.

FF = Fabric Filter.

ESP = Electrostatic Precipitator.



TABLE 4-4. CDF EMISSION FACTORS FOR CONTROLLED-AIR MEDICAL WASTE INCINERATORS

SCC 5-01-005-05, 5-02-005-05

Isomer	Uncontrolled			Fabric Filter			Wet Scrubber		
	lb/ton	kg/Mg	Factor Quality Rating	lb/ton	kg/Mg	Factor Quality Rating	lb/ton	kg/Mg	Factor Quality Rating
<b>TCDF</b>									
2,3,7,8-	2.40x10 <sup>-7</sup>	1.20x10 <sup>-7</sup>	E	3.85x10 <sup>-8</sup>	1.97x10 <sup>-8</sup>	E	1.26x10 <sup>-8</sup>	6.30x10 <sup>-9</sup>	E
Total TCDF	7.21x10 <sup>-6</sup>	3.61x10 <sup>-6</sup>	B	1.28x10 <sup>-6</sup>	6.39x10 <sup>-7</sup>	E	4.45x10 <sup>-7</sup>	2.22x10 <sup>-7</sup>	E
<b>PeCDF</b>									
1,2,3,7,8-	7.56x10 <sup>-10</sup>	3.78x10 <sup>-10</sup>	E				1.04x10 <sup>-9</sup>	5.22x10 <sup>-10</sup>	E
2,3,4,7,8-	2.07x10 <sup>-9</sup>	1.04x10 <sup>-9</sup>	E				3.07x10 <sup>-9</sup>	1.53x10 <sup>-9</sup>	E
Total PeCDF							6.18x10 <sup>-9</sup>	3.09x10 <sup>-9</sup>	E
<b>HxCDF</b>									
1,2,3,4,7,8-	7.55x10 <sup>-9</sup>	3.77x10 <sup>-9</sup>	E				8.96x10 <sup>-9</sup>	4.48x10 <sup>-9</sup>	E
1,2,3,6,7,8-	2.53x10 <sup>-9</sup>	1.26x10 <sup>-9</sup>	E				3.53x10 <sup>-9</sup>	1.76x10 <sup>-9</sup>	E
2,3,4,6,7,8-	7.18x10 <sup>-9</sup>	3.59x10 <sup>-9</sup>	E				9.59x10 <sup>-9</sup>	4.80x10 <sup>-9</sup>	E
1,2,3,7,8,9-							3.51x10 <sup>-10</sup>	1.76x10 <sup>-10</sup>	E
Total HxCDF							5.10x10 <sup>-9</sup>	2.55x10 <sup>-9</sup>	E
<b>HpCDF</b>									
1,2,3,4,6,7,8-	1.76x10 <sup>-8</sup>	8.78x10 <sup>-9</sup>	E				1.79x10 <sup>-8</sup>	8.97x10 <sup>-9</sup>	E
1,2,3,4,7,8,9-	2.72x10 <sup>-9</sup>	1.36x10 <sup>-9</sup>	E				3.50x10 <sup>-9</sup>	1.75x10 <sup>-9</sup>	E
Total HpCDF							1.91x10 <sup>-9</sup>	9.56x10 <sup>-10</sup>	E
Total OCDF	7.42x10 <sup>-8</sup>	3.71x10 <sup>-8</sup>	E				4.91x10 <sup>-10</sup>	2.45x10 <sup>-10</sup>	E
Total CDF	7.15x10 <sup>-5</sup>	3.58x10 <sup>-5</sup>	B	8.50x10 <sup>-6</sup>	4.25x10 <sup>-6</sup>	E	4.92x10 <sup>-6</sup>	2.46x10 <sup>-6</sup>	E

TABLE 4-4. CDF EMISSION FACTORS FOR CONTROLLED-AIR MEDICAL WASTE INCINERATORS (CONTINUED)

Isomer	Uncontrolled			Fabric Filter			Wet Scrubber		
	lb/ton	kg/Mg	Factor Quality Rating	lb/ton	kg/Mg	Factor Quality Rating	lb/ton	kg/Mg	Factor Quality Rating
TCDF									
2,3,7,8-	$4.93 \times 10^{-9}$	$2.47 \times 10^{-9}$	E	$7.31 \times 10^{-10}$	$3.65 \times 10^{-10}$	E	$1.73 \times 10^{-9}$	$8.66 \times 10^{-10}$	E
Total TCDF	$1.39 \times 10^{-7}$	$6.96 \times 10^{-8}$	E	$1.01 \times 10^{-8}$	$5.07 \times 10^{-9}$	E			
Total CDF	$1.47 \times 10^{-6}$	$7.37 \times 10^{-7}$	E	$9.47 \times 10^{-8}$	$4.74 \times 10^{-8}$	E			

Source: Reference 22.

DSI = Dry Sorbent Injection.

FF = Fabric Filter.

ESP = Electrostatic Precipitator.

TABLE 4-5. CDD AND CDF EMISSION FACTORS FOR ROTARY KILN MEDICAL WASTE INCINERATORS

SCC 5-01-005-05, 5-02-005-05  
 FACTOR QUALITY RATING: E

Isomer	<u>Uncontrolled</u>		<u>SD/FF</u>		<u>SD/Carbon Injection/FF</u>	
	lb/ton	kg/Mg	lb/ton	kg/Mg	lb/ton	kg/Mg
2,3,7,8-TCDD	6.61x10 <sup>-10</sup>	3.30x10 <sup>-10</sup>	4.52x10 <sup>-10</sup>	2.26x10 <sup>-10</sup>	6.42x10 <sup>-11</sup>	3.21x10 <sup>-11</sup>
Total TCDD	7.23x10 <sup>-9</sup>	3.61x10 <sup>-9</sup>	4.16x10 <sup>-9</sup>	2.08x10 <sup>-9</sup>	1.55x10 <sup>-10</sup>	7.77x10 <sup>-11</sup>
Total CDD	7.49x10 <sup>-7</sup>	3.75x10 <sup>-7</sup>	5.79x10 <sup>-8</sup>	2.90x10 <sup>-8</sup>	2.01x10 <sup>-8</sup>	1.01x10 <sup>-8</sup>
2,3,7,8-TCDF	1.67x10 <sup>-8</sup>	8.37x10 <sup>-9</sup>	1.68x10 <sup>-8</sup>	8.42x10 <sup>-9</sup>	4.96x10 <sup>-10</sup>	2.48x10 <sup>-10</sup>
Total TCDF	2.55x10 <sup>-7</sup>	1.27x10 <sup>-7</sup>	1.92x10 <sup>-7</sup>	9.58x10 <sup>-8</sup>	1.15x10 <sup>-8</sup>	5.74x10 <sup>-9</sup>
Total CDF	5.20x10 <sup>-6</sup>	2.60x10 <sup>-6</sup>	7.91x10 <sup>-7</sup>	3.96x10 <sup>-7</sup>	7.57x10 <sup>-8</sup>	3.78x10 <sup>-8</sup>

Source: Reference 22.

SD = Spray Dryer.  
 FF = Fabric Filter.

#### 4.1.3 Sewage Sludge Incineration

Sewage sludge incineration is used to dispose of sewage sludge generated by wastewater treatment from residential, commercial, and industrial establishments. Compared to other forms of sludge disposal, incineration has the advantages of reducing the solid mass and destroying or reducing organic matter in the sludge, as well as the potential for recovering energy. Disadvantages include the generation of ash which requires disposal and the potential release of air pollutant emissions.

## Process Description

The first step in the process of sewage sludge incineration is to dewater the sludge. Sludge is generally dewatered until it is about 15 to 30 percent solids, at which point it will burn without supplemental fuel. After dewatering, the sludge is sent to the incinerator for combustion. Unburned residual ash is removed from the incinerator, usually on a continuous basis, and disposed of. A portion of the noncombustible waste, as well as unburned VOCs, are carried out of the combustor through entrainment in the exhaust gas stream. APCDs, primarily wet scrubbers, are used to remove the entrained pollutants from the exhaust gas stream. The cleaned gas stream is then exhausted to the ambient air, and the scrubber water containing the collected pollutants is sent to the wastewater treatment plant.

Several types of incinerators and incineration technologies are used for sewage sludge incineration, including: (1) multiple-hearth furnaces (MHFs), (2) fluidized-bed combustors (FBCs), (3) electric incinerators, (4) co-incineration with refuse, (5) single-hearth cyclones, (6) rotary kilns, and (7) high-pressure wet-air oxidation. The first four types/technologies are described in this section. The others are not widely used in the United States and, therefore, are not described here.

Multiple-Hearth Furnaces (MHFs)--Figure 4-10 presents a typical MHF. The basic MHF is cylindrical in shape and is oriented vertically. The outer shell is constructed of steel and lined with refractory material and surrounds a series of horizontal refractory hearths. A hollow, rotating shaft runs through the center of the hearths. Attached to the central shaft are the rabble arms, which extend above the hearths. Each rabble arm is equipped with a number of teeth. As the central shaft rotates, the teeth on the rabble arms rake through the sludge and break up the solid material in order to increase the surface area exposed to heat and oxygen. The teeth are arranged on the arms to rake the sludge in a spiral motion, alternating in direction--from the outside in and from the inside out--between hearths. Burners located in the sidewalls of the hearths provide supplemental heat when necessary.

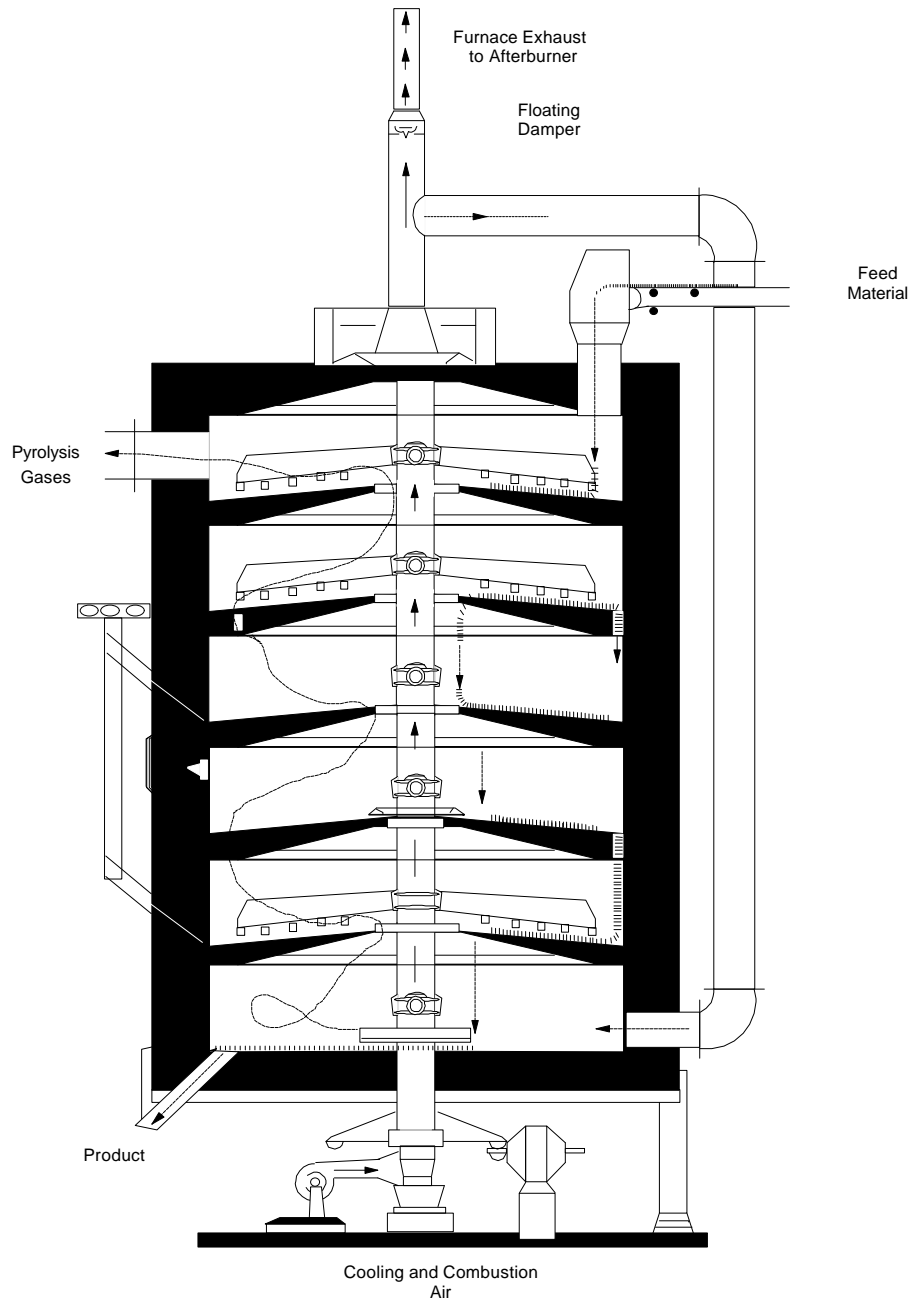

Figure 4-10. Cross Section of a Typical Multiple Hearth Furnace

Source: Reference 18.

Partially dewatered sludge is fed onto the perimeter of the top hearth by conveyors or pumps. The motion of the rabble arms rakes the sludge toward the center shaft, where it drops through holes onto the next hearth below and is raked in the opposite direction. This process is repeated on all of the subsequent hearths. Scum (material that floats on wastewater and is generally composed of vegetable and mineral oils, grease, hair, waxes, fats, and other materials that will float) may also be fed to one or more hearths. Scum may form in many treatment units, including the preparation tanks, the skimming tanks, and the sedimentation tanks. Quantities of scum are generally small compared to other wastewater solids.

Most of the moisture in the sludge is evaporated in the drying zone, which comprise the upper hearths of an MHF. The temperature in the drying zone is typically between 800 and 1,400°F (425 and 760°C). Sludge combustion occurs in the middle hearths as the temperature is increased to between 1,500 and 1,700°F (815 and 925°C). The cooling zone comprises the lowermost hearth(s), where the ash is cooled by the incoming combustion air.

Ambient air, introduced through the hollow central shaft and rabble arms by a fan, is used to cool the shaft and arms and to provide combustion air. A portion (or all) of this air is taken from the top of the shaft and recirculated into the lowermost hearth as preheated combustion air. Shaft cooling air that is not circulated into the furnace is ducted into the stack downstream of the APCDs. The combustion air flows upward through the drop holes in the hearths, countercurrent to the flow of the sludge, before being exhausted from the top hearth. Under normal operating conditions, 50 to 100 percent excess air must be added to an MHF in order to ensure complete combustion of the sludge and destruction of organics.<sup>18</sup>

MHFs are sometimes operated with afterburners to further reduce odors and concentrations of unburned organics. In an MHF with an afterburner, furnace exhaust gases are ducted to a chamber, where they are mixed with supplemental fuel and air and are completely combusted. Some MHFs have the flexibility to allow sludge to be fed to a lower hearth, thus allowing the upper hearth(s) to function essentially as an afterburner.

Fluidized-Bed Combustors (FBCs)--A typical FBC was presented earlier in Figure 4-6. FBCs are cylindrically shaped and oriented vertically with an outer shell constructed of steel and lined with refractory material. Nozzles designed to deliver blasts of air (called tuyeres) are located at the base of the furnace within a refractory-lined grid. A bed of sand approximately 2.5 feet (0.75 meters) thick rests on the grid.

Two general configurations can be distinguished on the basis of how the fluidizing air is injected into the furnace. In the hot windbox design, the combustion air is first preheated by passing it through a heat exchanger, where heat is recovered from the hot flue gases. Alternatively, ambient air can be injected directly into the furnace from a cold windbox.

Partially dewatered sludge is fed onto the furnace bed. The bed is maintained at temperatures of 1,350 to 1,500°F (725 to 825°C). Air injected through the tuyeres fluidizes simultaneously the bed of hot sand and the incoming sludge. Fluidization of the bed achieves nearly ideal mixing between the sludge and the combustion air, and the turbulence facilitates the transfer of heat from the hot sand to the sludge. As the temperature of the sludge rapidly increases, evaporation of the moisture and combustion of the organic materials occur almost simultaneously. The remaining combustible gases are burned in the area above the furnace bed (the freeboard area). The freeboard area functions essentially as an afterburner. FBCs can achieve complete combustion with 20 to 50 percent excess air.<sup>18</sup>

Electric Incinerators--A cross-section of a typical electric incinerator is presented in Figure 4-11. An electric incinerator consists of a horizontally oriented, insulated furnace. A belt conveyor extends through the length of the furnace, and infrared heating elements are located in the roof of the furnace above the conveyor. Electric incinerators consist of a number of prefabricated modules that can be linked together to provide the necessary furnace length.

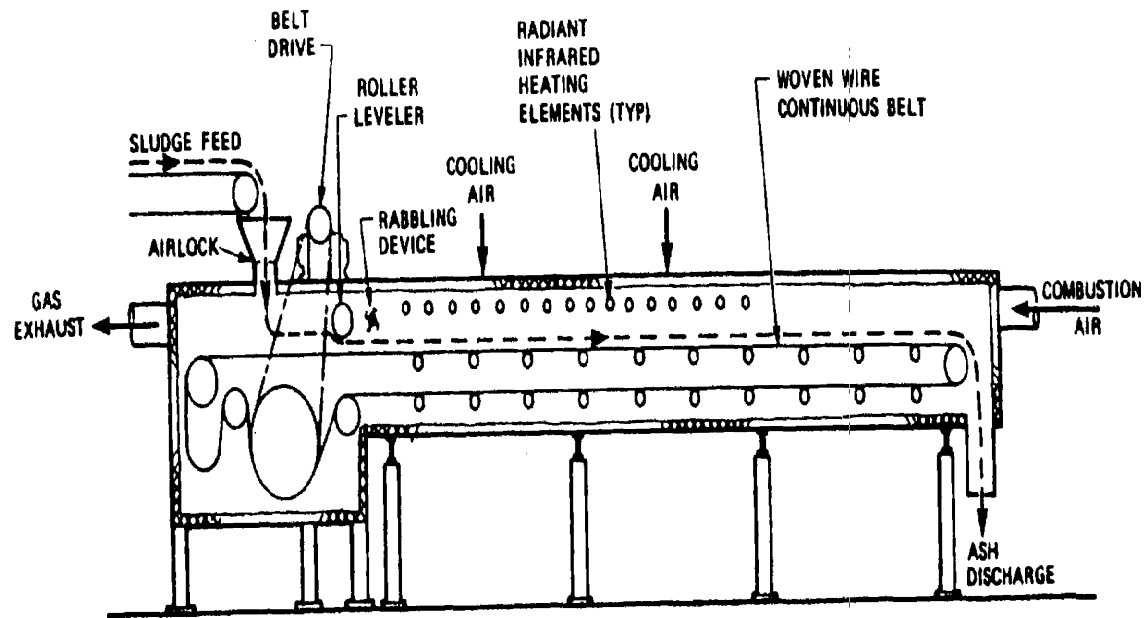

Figure 4-11. Cross Section of an Electric Infrared Furnace

Source: Reference 18.



Dewatered sludge is deposited on the conveyor belt at the entrance of the incinerator. A roller mechanism levels the sludge into a continuous layer approximately 1 inch thick across the width of the belt. As the sludge travels through the incinerator and beneath the heating elements, it is dried and then burned. The ash remaining on the belt is discharged into a hopper at the exit end of the incinerator.

Combustion air that has been preheated by the flue gases is introduced into the furnace above the ash hopper and is further heated by the ash. The direction of air flow is countercurrent to the movement of the sludge on the conveyor and the exhaust gases exit the furnace at the feed end. Excess air rates for electric incinerators vary from 20 to 70 percent.

Co-incineration with Refuse--Virtually any material that can be burned can be combined with sludge in a co-combustion process. Common materials for co-incineration are coal, municipal solid waste (MSW), wood waste, and agriculture waste. Rotary kilns and other incinerators with feed and grate systems that will handle sewage sludge are used for co-incineration. When sludge is combined with other combustible materials in a co-combustion scheme, a furnace feed may be created that has both a low water concentration and a heat value high enough to sustain combustion with little or no supplemental fuel.

There are two basic methods for combusting sewage sludge with MSW: (1) by adding dewatered or dried sludge along with MSW to a municipal waste combustor, and (2) by adding processed MSW along with sludge to a sewage sludge incinerator. With the latter method, MSW is processed by removing noncombustibles, shredding, and screening.

#### Emission Control Techniques

Emissions of CDD/CDF and other organics from sewage sludge incinerators are most effectively controlled by maximizing in-furnace destruction of organics and collecting PM in an APCD. In-furnace destruction of organics is accomplished by optimizing waste feeding

procedures, achieving adequate combustion temperatures, providing the proper amount and distribution of combustion air, and optimizing the mixing process. Following these practices will ensure more complete combustion of the waste and destruction of CDD/CDF and other organics.

Organics, including CDD/CDF, can exist in the vapor phase or can be condensed or absorbed onto PM; therefore, control of PM emissions can result in a decrease in CDD/CDF emissions. Particulate emissions from sewage sludge incinerators have historically been controlled by wet scrubbers because the associated sewage treatment plant provides both a convenient water supply to the scrubber and a means of disposing of the water after it passes through the scrubber. Other types of PM controls range from low-pressure-drop spray towers and wet cyclones to higher-pressure-drop venturi scrubbers and venturi/impingement tray scrubber combinations. ESPs are sometimes used on incinerators that co-fire sludge with MSW.

#### Emission Factors

The CDD/CDF emission factors presented in this section were developed from information contained in several test reports and AP-42.<sup>24-31</sup> These reports contain results of test programs performed at several MHFs and one FBC and include a description of each incinerator tested, the number of test runs performed in each test program, and the concentrations of CDD/CDF obtained for each test run.

Emissions data for electric incinerators and for facilities that co-incinerate sewage sludge with refuse were unavailable at the time this document was prepared; therefore, emission factors for these types of incinerators are not presented. Only data from tests that were performed under normal operating conditions were used to develop the emission factors in this report.

Tables 4-6 and 4-7 present the emission factors for CDD and CDF for each MHF and FBC tested. The emission factors for MHFs are reported by the type of control device employed.

#### Source Locations

There were 143 sewage sludge facilities in operation in the United States in 1995. Of the three main types of incinerators used, over 80 percent are of the multiple-hearth design, about 15 percent are FBCs, and about 3 percent are electric incinerators. The remaining incinerators co-fire MSW with sludge.<sup>18,31</sup>

Approximately 6.5 million dry tons (5.9 million dry megagrams) of sludge are generated in U.S. municipal wastewater plants each year.<sup>18</sup> It is estimated that 25 percent of this sludge is incinerated. Most sludge incineration facilities are located in the eastern United States, although there are a significant number on the west coast. New York has the largest number of facilities (33). Pennsylvania and Michigan have 21 and 19 sites, respectively.<sup>18,31</sup>

#### 4.1.4 Hazardous Waste Incineration

Hazardous waste, as defined by the Resource Conservation and Recovery Act (RCRA) in Title 40 CFR Part 261, includes a wide variety of waste materials. Generally, a discarded material may be a hazardous waste if (1) the waste exhibits ignitability, corrosivity, reactivity, and toxicity; or (2) if the waste meets the criteria specified by RCRA to be a listed hazardous waste. There are four categories of listed hazardous waste: (1) wastes generated from nonspecific sources (e.g., solvent wastes); (2) specific wastes generated from specific sources (e.g., petroleum refineries); (3) unused acutely hazardous commercial chemical products [listed in 40 CFR §261.33(e)]; and (4) unused hazardous commercial chemical products [listed in 40 CFR §261.33(f)].

TABLE 4-6. CDD AND CDF EMISSION FACTORS FOR MULTIPLE-HEARTH SEWAGE  
SLUDGE INCINERATORS<sup>a</sup>

SCC 5-01-005-15

FACTOR QUALITY RATING: E

Source Category	<u>2,3,7,8-TCDD</u>		<u>Total TCDD</u>		<u>Total PeCDD</u>		<u>Total HxCDD</u>	
	lb/ton	μg/Mg	lb/ton	μg/Mg	lb/ton	μg/Mg	lb/ton	μg/Mg
Uncontrolled			1.3x10 <sup>-7</sup>	6.3x10 <sup>1</sup>	5.4x10 <sup>-9</sup>	2.7	1.4x10 <sup>-7</sup>	6.8x10 <sup>1</sup>
Controlled								
Cyclone/venturi			2.8x10 <sup>-9</sup>	1.4				
Cyclone/venturi/ impingement	6.0x10 <sup>-10</sup>	3.0x10 <sup>-1</sup>					8.8x10 <sup>-9</sup>	4.4
Impingement	1.0x10 <sup>-9</sup>	5.0x10 <sup>-1</sup>	5.6x10 <sup>-8</sup>	2.8x10 <sup>1</sup>	7.4x10 <sup>-9</sup>	3.7	4.8x10 <sup>-8</sup>	2.4x10 <sup>1</sup>
Venturi/impingement/ afterburner	1.8x10 <sup>-9</sup>	9.0x10 <sup>-1</sup>					1.2x10 <sup>-7</sup>	6.0x10 <sup>1</sup>
Venturi/impingement	4.0x10 <sup>-9</sup>	2.0					7.6x10 <sup>-8</sup>	3.8x10 <sup>1</sup>

<sup>a</sup> Emission factors are reported as lb (μg) of pollutant emitted per ton (Mg) of dry sludge burned.

TABLE 4-6. CDD AND CDF EMISSION FACTORS FOR MULTIPLE-HEARTH SEWAGE  
SLUDGE INCINERATORS<sup>a</sup> (CONTINUED)

Source Category	Total HpCDD		Total OCDD		Total Tetra through Octa CDD	
	lb/ton	μg/Mg	lb/ton	μg/Mg	lb/ton	μg/Mg
Uncontrolled	6.8x10 <sup>-7</sup>	3.4x10 <sup>2</sup>	7.4x10 <sup>-7</sup>	3.7x10 <sup>2</sup>	1.7x10 <sup>-6</sup>	8.5x10 <sup>2</sup>
Controlled						
Cyclone/venturi	1.6x10 <sup>-9</sup>	8.0x10 <sup>-1</sup>	6.8x10 <sup>-9</sup>	3.4	1.1x10 <sup>-8</sup>	5.6
Cyclone/venturi/ impingement	2.8x10 <sup>-8</sup>	1.4x10 <sup>1</sup>	6.7x10 <sup>-8</sup>	3.1x10 <sup>1</sup>	2.2x10 <sup>-7</sup>	1.1x10 <sup>2</sup>
Impingement	1.5x10 <sup>-7</sup>	7.3x10 <sup>1</sup>	1.1x10 <sup>-7</sup>	5.3x10 <sup>1</sup>	3.6x10 <sup>-7</sup>	1.8x10 <sup>2</sup>
Venturi/impingement/ afterburner	4.6x10 <sup>-8</sup>	2.3x10 <sup>1</sup>	2.4x10 <sup>-8</sup>	1.2x10 <sup>1</sup>	6.2x10 <sup>-7</sup>	3.1x10 <sup>2</sup>
Venturi/impingement	3.0x10 <sup>-8</sup>	1.5x10 <sup>1</sup>	3.8x10 <sup>-8</sup>	1.9x10 <sup>1</sup>	5.4x10 <sup>-7</sup>	2.7x10 <sup>2</sup>

<sup>a</sup> Emission factors are reported as lb (μg) of pollutant emitted per ton (Mg) of dry sludge burned.

TABLE 4-6. CDD AND CDF EMISSION FACTORS FOR MULTIPLE-HEARTH SEWAGE  
SLUDGE INCINERATORS<sup>a</sup> (CONTINUED)

Source Category	<u>2,3,7,8-TCDF</u>		<u>Total TCDF</u>		<u>Total PeCDF</u>		<u>Total HxCDF</u>	
	lb/ton	μg/Mg	lb/ton	μg/Mg	lb/ton	μg/Mg	lb/ton	μg/Mg
Uncontrolled	1.2x10 <sup>-6</sup>	6.2x10 <sup>2</sup>	3.4x10 <sup>-6</sup>	1.7x10 <sup>3</sup>	2.0x10 <sup>-6</sup>	9.8x10 <sup>2</sup>	2.0x10 <sup>-7</sup>	9.9x10 <sup>1</sup>
Controlled								
Cyclone/venturi	1.1x10 <sup>-8</sup>	5.6	1.0x10 <sup>-7</sup>	5.0x10 <sup>1</sup>	2.2x10 <sup>-8</sup>	1.1x10 <sup>1</sup>	6.8x10 <sup>-9</sup>	3.4
Cyclone/venturi/ impingement			3.8x10 <sup>-7</sup>	1.8x10 <sup>2</sup>	1.1x10 <sup>-7</sup>	5.7x10 <sup>1</sup>	3.6x10 <sup>-9</sup>	1.8
Impingement	3.6x10 <sup>-7</sup>	1.8x10 <sup>2</sup>	1.4x10 <sup>-6</sup>	7.0x10 <sup>2</sup>	7.2x10 <sup>-7</sup>	3.6x10 <sup>2</sup>	2.2x10 <sup>-7</sup>	1.1x10 <sup>2</sup>
Venturi/impingement/ afterburner	1.1x10 <sup>-7</sup>	5.4x10 <sup>1</sup>	7.0x10 <sup>-7</sup>	3.5x10 <sup>2</sup>	2.6x10 <sup>-7</sup>	1.3x10 <sup>2</sup>	1.5x10 <sup>-7</sup>	7.8x10 <sup>1</sup>
Venturi/impingement	9.2x10 <sup>-8</sup>	4.6x10 <sup>1</sup>	1.2x10 <sup>-6</sup>	6.0x10 <sup>2</sup>	2.6x10 <sup>-9</sup>	1.3	1.1x10 <sup>-7</sup>	5.7x10 <sup>1</sup>

<sup>a</sup> Emission factors are reported as lb (μg) of pollutant emitted per ton (Mg) of dry sludge burned.

TABLE 4-6. CDD AND CDF EMISSION FACTORS FOR MULTIPLE-HEARTH SEWAGE  
SLUDGE INCINERATORS<sup>a</sup> (CONTINUED)

Source Category	Total HpCDF		Total OCDF		Total Tetra through Octa CDF	
	lb/ton	μg/Mg	lb/ton	μg/Mg	lb/ton	μg/Mg
Uncontrolled	9.6x10 <sup>-7</sup>	4.8x10 <sup>2</sup>	9.8x10 <sup>-7</sup>	4.9x10 <sup>2</sup>	7.6x10 <sup>-6</sup>	3.8x10 <sup>3</sup>
Controlled						
Cyclone/venturi	1.8x10 <sup>-9</sup>	9.0x10 <sup>-1</sup>	1.4x10 <sup>-9</sup>	7.0x10 <sup>-1</sup>	1.3x10 <sup>-7</sup>	6.6x10 <sup>1</sup>
Cyclone/venturi/ impingement	5.8x10 <sup>-9</sup>	2.9	3.6x10 <sup>-9</sup>	1.8	5.0x10 <sup>-7</sup>	2.5x10 <sup>2</sup>
Impingement	4.0x10 <sup>-7</sup>	2.0x10 <sup>2</sup>	3.0x10 <sup>-7</sup>	1.5x10 <sup>2</sup>	3.0x10 <sup>-6</sup>	1.5x10 <sup>3</sup>
Venturi/impingement/ afterburner	9.6x10 <sup>-8</sup>	4.8x10 <sup>1</sup>	1.5x10 <sup>-8</sup>	7.7	9.2x10 <sup>-7</sup>	4.6x10 <sup>2</sup>
Venturi/impingement	8.2x10 <sup>-8</sup>	4.1x10 <sup>1</sup>	1.3x10 <sup>-8</sup>	6.3	1.9x10 <sup>-6</sup>	9.3x10 <sup>2</sup>

Source: Reference 31.

<sup>a</sup> Emission factors are reported as lb (μg) of pollutant emitted per ton (Mg) of dry sludge burned.

TABLE 4-7. CDD AND CDF EMISSION FACTORS FOR FLUIDIZED-BED SEWAGE  
 SLUDGE INCINERATORS<sup>a</sup>  
 SCC 5-01-005-16  
 FACTOR QUALITY RATING: E

Isomer	<u>Uncontrolled</u>		<u>Venturi/Impingement</u>	
	lb/ton	g/Mg	lb/ton	g/Mg
2,3,7,8-TCDD			6.0x10 <sup>-10</sup>	3.0x10 <sup>-7</sup>
Total TCDD			4.4x10 <sup>-9</sup>	2.2x10 <sup>-6</sup>
Total PeCDD	2.2x10 <sup>-9</sup>	1.1x10 <sup>-6</sup>		
Total HxCDD			1.8x10 <sup>-9</sup>	9.0x10 <sup>-7</sup>
Total HpCDD			1.8x10 <sup>-9</sup>	9.0x10 <sup>-7</sup>
Total OCDD			8.6x10 <sup>-9</sup>	4.3x10 <sup>-6</sup>
2,3,7,8-TCDF			4.0x10 <sup>-10</sup>	2.0x10 <sup>-7</sup>
Total TCDF			1.2x10 <sup>-8</sup>	6.2x10 <sup>-6</sup>
Total PeCDF			1.0x10 <sup>-8</sup>	5.2x10 <sup>-6</sup>
Total HxCDF			8.2x10 <sup>-9</sup>	4.1x10 <sup>-6</sup>
Total HpCDF			3.2x10 <sup>-9</sup>	1.6x10 <sup>-6</sup>
Total OCDF			2.6x10 <sup>-9</sup>	1.3x10 <sup>-6</sup>

Source: Reference 31.

<sup>a</sup> Emission factors are reported as lb (g) of pollutant emitted per ton (Mg) of dry sludge burned.



Hazardous waste is incinerated in order to destroy the hazardous constituents of the waste and/or reduce the bulk of the waste. Hazardous waste can be burned under oxidative or pyrolytic conditions in hazardous waste incinerators designed specifically for this purpose or in various types of industrial boilers and furnaces.

The primary purpose of a hazardous waste incinerator is to destroy the hazardous constituents of the waste. The primary purpose of burning hazardous wastes in industrial boilers and furnaces is to recover energy. These units use the recovered energy in addition to energy from a primary fuel to produce a commercially viable product such as cement, lime, or steam. In the process of producing energy and heat, the hazardous content or the bulk of the waste is destroyed.

#### Process Descriptions

Several types of incinerators, boilers, and furnaces are used to incinerate hazardous waste. The most common types of each are discussed in this section.

Hazardous Waste Incinerators--Five types of hazardous waste incinerators are currently available and in operation in the United States: liquid-injection, fume-injection, fixed-hearth, fluidized-bed, and rotary kiln.

Liquid-injection incinerators are usually single-chamber units and may be either vertically or horizontally oriented. Liquid wastes are transferred from drums or tank trucks into a feed tank, where recirculation systems or mixers are used to mix the tank contents. Before introduction of the waste, a gaseous auxiliary fuel (such as propane) is normally used to preheat the incinerator system to an equilibrium temperature. The waste is then pumped from the tank and sent either directly to the incinerator or to a blending tank to be combined with other wastes before incineration. The waste is atomized by gas-fluid nozzles and injected into the incinerator. Liquid-injection incinerators can incinerate a wide range of liquid wastes but are unsuitable for

noncombustibles, wastes with a high moisture content, inert materials, inorganic salts, and materials with a high inorganic content.

Fume-injection incinerators are very similar to liquid-injection incinerators in design and are used to destroy gaseous or fume wastes.

The combustion chamber of the fixed-hearth incinerator is a stationary unit into which solids and sludges are introduced and burned. Units of this type may have a single (primary) combustion chamber or may have two chambers (primary and secondary). Fixed-hearth incinerators are usually equipped with oil or gas burners for start-up and for providing auxiliary fuel as needed. Combustion in these units is enhanced by the addition of a grate system, which allows combustion air to flow above and below the waste. Solids and sludges are fed into the primary chamber, where they are burned. Liquid waste may be introduced into either the primary or secondary chamber.

Fluidized-bed combustors (FBCs) were previously described in the Sewage Sludge Incineration section of this report. FBCs used to dispose of hazardous waste are very similar to those used to incinerate sewage sludge except for their additional capability of handling liquid wastes. FBCs are suitable for disposing of combustible solids, liquids, and gaseous wastes. They are not suited for irregular, bulky wastes, tarry solids, or other wastes that leave residues in the bed.<sup>31,32</sup>

Rotary kiln incinerators have a combustion chamber that is slightly inclined from the horizontal and rotates. Rotary kilns were described earlier in the Medical Waste Incineration section of this report. Rotary kilns are designed to incinerate many types of waste, hazardous or nonhazardous. Solid, liquid, and containerized wastes are usually fed simultaneously to the kiln, but liquid wastes also may be injected into the afterburner. The rotary kiln incinerator can be used to destroy any form of hazardous waste material that is combustible. It has also been shown to be useful for decontaminating noncombustible materials such as soils and capacitors. Rotary kilns

are not suited for wastes with a high moisture content or that contain significant amounts of toxic metals.

Boilers--In contrast to incinerators, whose main objective is to destroy the hazardous constituents of wastes, boilers are constructed to produce steam for electricity generation (utility boilers) or for on-site process needs (industrial boilers). Also, hazardous wastes compose the primary feed to incinerators, whereas they are usually a supplementary fuel for boilers. The concept of disposing of hazardous wastes in boilers has centered around industrial boilers because their operation is more flexible than utility boiler operation, and they offer the potential of destroying hazardous wastes generated on site.

The primary fuels used in industrial boilers are gas, oil, coal, and wood. Industrial boilers may be distinguished by their type of fuel-firing mode. The major types of firing modes are single- or opposed-wall, tangential, cyclone, and stoker. The terms single- or opposed-wall and tangential refer to the arrangement of the burners in the combustion chamber. In cyclone-fired units, fuel and air are introduced circumferentially into a water-cooled, cylindrical combustion chamber. Stoker-fired boilers are designed to burn solid fuels on a bed. The bed is either a stationary grate through which ash falls or a moving grate that dumps the ash into a hopper.

Industrial Furnaces--Industrial furnaces are defined as designated devices that are an integral component of a manufacturing process and that use thermal treatment to recover materials or energy. Types of industrial furnaces are cement kilns, lime kilns, lightweight aggregate kilns, phosphate kilns, and coke ovens. The types of industrial furnaces are too numerous for process descriptions to be included here. Basically, they are alike in that industrial furnaces are used to liberate heat and transfer the heat directly or indirectly to a solid or fluid material for the purpose of effecting a physical or chemical change. Industrial furnaces usually have a chamber(s) in which the material is processed into a product. Their operation and function

can be compared to those of a kitchen oven. Primary fuels for industrial furnaces are normally oil, gas, or coal. Waste fuels include used lube oil, hydraulic fluid, coolant oil, and metal-working oil.

### Emission Control Techniques

Emissions of CDD/CDF from hazardous waste incinerators and industrial boilers and furnaces are most effectively controlled by GCP and collection of PM in an effective APCD. GCP can maximize destruction of organics in the furnace. Wet scrubbers and ESPs are the most common APCDs used on these three types of units to control PM emissions.

### Emission Factors

Emission factors for CDD/CDF from hazardous waste incinerators and industrial boilers and furnaces, or information from which emission factors may be developed, are not readily available. Emissions depend on the constituents in the waste stream being combusted, and waste streams often vary greatly from facility to facility. Therefore, CDD/CDF emission factors developed for one facility would be specific only to that facility. This section presents CDD/CDF emissions data (concentrations in flue gas) that were compiled during a literature review, and CDD/CDF emission factors (kg/Mg waste combusted) that were developed from data contained in a test report.<sup>32,33</sup>

Emissions data from tests at six incinerators, five boilers, three calcining kilns, and three PCB incinerators are summarized in the literature review report.<sup>33</sup> This summary is partially reproduced in Table 4-8. Concentrations of CDD/CDF in the flue gas at each facility are presented in units of nanograms per cubic meter (ng/m<sup>3</sup>). Of the 17 facilities tested, only five emitted detectable levels of CDD or CDF. The 2,3,7,8-TCDD isomer was not detected at any of the facilities. The highest CDD levels reported were for an industrial boiler using a creosote/pentachlorophenol (PCP) waste.

TABLE 4-8. SUMMARY OF TOTAL CDD/CDF CONCENTRATIONS MEASURED AT HAZARDOUS WASTE THERMAL DESTRUCTION FACILITIES

Facility Type	Sample (waste) <sup>a</sup>	Total CDD (ng/m <sup>3</sup> )	Total CDF (ng/m <sup>3</sup> )
Commercial rotary kiln/ liquid injection	FG/FA (HW)	ND	ND-1.7
Fixed-hearth incinerator	FG/FA (HW)	16	56
Liquid-injection incinerator	FG/FA (HW)	ND	ND
Horizontal liquid-injection incinerator	FG/FA (HW)	ND	7.3
Incinerator ship	FG/FA (PCB)	ND	0.3-3
4 lime/cement kilns	FG (HW)	ND	ND
Fixed-hearth incinerator	FG/FA (HW)	ND	ND
Rotary kiln/liquid-injection	FG (PCB)	ND-48	0.6-95
Industrial boiler	FG/FA (PCP)	75-76	ND
Industrial boiler	FG/FA (HW)	0.64-0.8	ND
Industrial boiler	FG/FA (HW)	ND	ND
Industrial boiler	FG/FA (HW)	ND	ND
Industrial boiler	FG/FA (HW)	1.1	ND

Source: Reference 33.

Note: 2,3,7,8-TCDD was not detected at any facility.

<sup>a</sup> Information in parentheses describes waste feed.

FG = Flue gases analyzed.  
 FA = Flue gas particulate analyzed.  
 HW = Hazardous waste.  
 PCB = Polychlorinated biphenyls.  
 PCP = Pentachlorophenol waste.  
 ND = Not detected.

Table 4-9 presents emission factors developed from information contained in one test report.<sup>32</sup> This report presents the results of a test program performed at EPA's Incineration Research Facility (IRF). Test conditions were designed to evaluate the effectiveness of varying incinerator operating conditions on the destruction of PCB and other pollutants. The IRF incinerator is a rotary kiln equipped with an afterburner. APCDs used during the test program consisted of a venturi scrubber followed by a packed-column scrubber. The waste feed to the incinerator was PCB-contaminated marine sediments. The sediments were spiked with PCB transformer fluid to increase the sediment PCB content from nominally 12 lb/ton (6,000 milligrams per kilogram [mg/kg]) to 92 lb/ton (46,000 mg/kg), a level that allowed an unambiguous determination of whether a PCB destruction and removal efficiency (DRE) of 99.9999 percent could be achieved. The emission factors presented in Table 4-9 were developed from data from three test runs at the facility. The 2,3,7,8- isomers and PeCDD/PeCDF through OCDD/OCDF were detected in each test run.

Overall, it appeared that emissions of CDD/CDF from hazardous waste incinerators and industrial boilers and furnaces were not significant, but they can occur. As with other types of refuse combustion, CDD/CDF emissions from these types of facilities are highly dependent on the type of waste feed and incinerator operating practices.

#### Source Locations

Approximately 227 hazardous waste incinerators are in operation in the United States and Puerto Rico. Texas has the most with 27 facilities (12 percent), followed by Louisiana and Ohio, each with 17 facilities (7 percent), and California with 15 facilities (7 percent). Thirty-eight states, each with between 1 and 12 incinerators, together account for 12 percent of the total.<sup>34</sup>

TABLE 4-9. CDD/CDF EMISSION FACTORS FOR A HAZARDOUS WASTE  
INCINERATOR BURNING PCB-CONTAMINATED SEDIMENTS  
SCC 5-03-005-01  
FACTOR QUALITY RATING: E

Isomer	Emission Factors <sup>a</sup> lb/ton (kg/Mg) Refuse Combusted		
	Average	Range	
		Minimum	Maximum
<b>DIOXINS</b>			
2,3,7,8-TCDD	1.7x10 <sup>-10</sup> (8.42x10 <sup>-11</sup> )	1.6x10 <sup>-10</sup> (7.92x10 <sup>-11</sup> )	1.8x10 <sup>-10</sup> (8.81x10 <sup>-11</sup> )
Total TCDD	6.4x10 <sup>-10</sup> (3.22x10 <sup>-10</sup> )	4.2x10 <sup>-10</sup> (2.11x10 <sup>-10</sup> )	9.4x10 <sup>-10</sup> (4.70x10 <sup>-10</sup> )
Total PeCDD	3.8x10 <sup>-10</sup> (1.88x10 <sup>-10</sup> )	2.6x10 <sup>-10</sup> (1.32x10 <sup>-10</sup> )	5.7x10 <sup>-10</sup> (2.85x10 <sup>-10</sup> )
Total HxCDD	5.1x10 <sup>-10</sup> (2.54x10 <sup>-10</sup> )	4.2x10 <sup>-10</sup> (2.11x10 <sup>-10</sup> )	6.5x10 <sup>-10</sup> (3.23x10 <sup>-10</sup> )
Total HpCDD	9.3x10 <sup>-10</sup> (4.64x10 <sup>-10</sup> )	4.7x10 <sup>-10</sup> (2.35x10 <sup>-10</sup> )	1.3x10 <sup>-9</sup> (6.55x10 <sup>-10</sup> )
Total OCDD	2.5x10 <sup>-9</sup> (1.25x10 <sup>-9</sup> )	1.6x10 <sup>-9</sup> (7.92x10 <sup>-10</sup> )	3.4x10 <sup>-9</sup> (1.71x10 <sup>-9</sup> )
Total CDD	5.1x10 <sup>-9</sup> (2.56x10 <sup>-9</sup> )	3.3x10 <sup>-9</sup> (1.67x10 <sup>-9</sup> )	7.0x10 <sup>-9</sup> (3.52x10 <sup>-9</sup> )
<b>FURANS</b>			
2,3,7,8-TCDF	1.9x10 <sup>-8</sup> (9.54x10 <sup>-9</sup> )	1.4x10 <sup>-8</sup> (7.13x10 <sup>-9</sup> )	2.7x10 <sup>-8</sup> (1.35x10 <sup>-8</sup> )
Total TCDF	1.1x10 <sup>-7</sup> (5.72x10 <sup>-8</sup> )	7.8x10 <sup>-8</sup> (3.91x10 <sup>-8</sup> )	1.6x10 <sup>-7</sup> (8.19x10 <sup>-8</sup> )
Total PeCDF	2.9x10 <sup>-8</sup> (1.43x10 <sup>-8</sup> )	1.7x10 <sup>-8</sup> (8.55x10 <sup>-9</sup> )	4.6x10 <sup>-8</sup> (2.29x10 <sup>-8</sup> )
Total HxCDF	6.5x10 <sup>-9</sup> (3.26x10 <sup>-9</sup> )	4.0x10 <sup>-9</sup> (1.99x10 <sup>-9</sup> )	7.9x10 <sup>-9</sup> (3.96x10 <sup>-9</sup> )
Total HpCDF	5.1x10 <sup>-10</sup> (2.56x10 <sup>-10</sup> )	1.1x10 <sup>-10</sup> (5.28x10 <sup>-11</sup> )	1.1x10 <sup>-9</sup> (5.70x10 <sup>-10</sup> )
Total OCDF	7.3x10 <sup>-10</sup> (3.63x10 <sup>-10</sup> )	5.7x10 <sup>-10</sup> (2.85x10 <sup>-10</sup> )	8.5x10 <sup>-10</sup> (4.23x10 <sup>-10</sup> )
Total CDF	1.7x10 <sup>-7</sup> (8.49x10 <sup>-8</sup> )	1.1x10 <sup>-7</sup> (5.68x10 <sup>-8</sup> )	2.4x10 <sup>-7</sup> (1.21x10 <sup>-7</sup> )

Source: Reference 32.

<sup>a</sup> Emission factors developed from three test runs at one unit. Control device = venturi scrubber and packed column scrubber.

There are approximately 23,000 fossil-fuel-fired industrial boilers in the United States.<sup>35</sup> The number of boilers located in each state is unknown, but with such a large number of boilers in operation, it is likely that industrial boilers are located in every state.

The total number of industrial furnaces in operation in the United States is unknown. There are 143 cement plants in operation in 40 states. Texas has the largest number of facilities with 18, followed by Pennsylvania with 15. There were 137 lime production plants in 38 states in operation in 1984. The state with the most facilities was Ohio with 15. California was second, with 13 plants in operation.<sup>33</sup>

#### 4.1.5 Industrial Waste Incineration

Industrial wastes are nonhazardous materials generated by a process or operation. These wastes are deemed worthless and cannot be further refined or recycled to produce a product. Almost all industries generate some type of waste. Industries that generate combustible wastes such as wood, paper, or plastic sometimes incinerate their own wastes. Incineration of these wastes is a disposal method and it also provides a source of energy that can be captured and used in a process or operation. The combustion of industrial wood wastes in boilers is discussed specifically in Section 4.2.2 of this report.

##### Process Description

Industrial wastes are usually solid materials and may be disposed of in various types of incinerators or co-fired with another fuel in boilers. Combustion chambers in incinerators used to dispose of industrial waste are usually equipped with a grate system so that air can flow over and under the waste, thereby enhancing combustion. These incinerators normally have an afterburner to aid combustion and a waste heat boiler to generate steam.



## Emission Control Techniques

Emissions of CDD/CDF from industrial waste incinerators may be controlled by GCP (as described earlier in Section 4.1.2) and with devices such as scrubbers and fabric filters that are used on other incinerators to control particulate emissions. No data were available at the time this report was prepared on the extent to which specific control devices are used on industrial waste incinerators.

## Emission Factors

Only one report of emissions testing at an industrial waste incinerator was located for the preparation of this report.<sup>36</sup> The test was performed at a facility that manufactures wooden doors and windows. Various wastes from the plant, including wood scraps, plastic-coated wooden window frame pieces, paint sludges, paint filters, dry paint, paper, and cardboard were burned in the incinerator. Heat generated in the incinerator was recovered using waste heat boilers.

The incinerator was batch-fed and had primary and secondary combustion chambers. The secondary chamber was a refractory-lined duct with oil-fired burners. Hot gases from the secondary chamber passed through the waste heat boiler prior to being exhausted through a stack. There was no pollution control device on the incinerator.

Waste feed to the incinerator during testing averaged 1.19 ton/hr (1,083 kg/hr). The feed material to the incinerator consisted of crate, wood, paper, cardboard (67 percent by weight of the total feed), PCP-treated wood (6 percent by weight), painted wood (14.5 percent by weight), wood treated with PCP and coated with polyvinyl chloride (13 percent by weight), water-based paint (0.6 percent by weight), and oil-based paint (0.6 percent by weight).

The CDD/CDF emission factors developed from the emissions data presented in the test report are presented in Table 4-10. Three test runs were performed; the 2,3,7,8-isomers and TCDD/TCDF through OCDD/OCDF homologues were detected in all test runs.

Because these emission factors are for a specific site, they should not be used to estimate emissions from other industrial waste incinerators without considering the different operating conditions and feed material composition.

#### Source Locations

The total number of industrial waste incinerators in operation in the United States is unknown. Because there are a large number of processes and operations that generate combustible wastes, the potential number of industrial waste incinerators is very large, and some are probably located in every state.

#### 4.2 COMBUSTION OF SOLID AND LIQUID FUELS IN STATIONARY SOURCES FOR HEAT AND POWER GENERATION

This section covers the combustion of solid and liquid fuels in stationary sources for heat and power generation in the utility, industrial, and residential sectors. Potential sources of emissions in these sectors include utility plants, industrial boilers, and domestic combustion units. These sources burn some or all of the following fuels: coal, oil, natural gas, and wood. CDD/CDF emissions from these sources may occur as a result of incomplete combustion of hydrocarbons in the furnace or downstream formation in ductwork or air pollution control devices. However, these sources are not generally considered major sources of CDD/CDF emissions.

TABLE 4-10. CDD/CDF EMISSION FACTORS FOR AN INDUSTRIAL  
WASTE INCINERATOR  
SCC 5-03-001-01  
FACTOR QUALITY RATING: E

Isomer	Emission Factors <sup>a</sup> lb/ton (kg/Mg) Refuse Combusted		
	Average	Range	
		Minimum	Maximum
<b>DIOXINS</b>			
2,3,7,8-TCDD	2.5x10 <sup>-8</sup> (1.27x10 <sup>-8</sup> )	1.1x10 <sup>-8</sup> (5.69x10 <sup>-9</sup> )	4.2x10 <sup>-8</sup> (2.11x10 <sup>-8</sup> )
Total TCDD	4.7x10 <sup>-7</sup> (2.34x10 <sup>-7</sup> )	2.0x10 <sup>-7</sup> (9.96x10 <sup>-8</sup> )	7.9x10 <sup>-7</sup> (3.96x10 <sup>-7</sup> )
Total PeCDD	5.8x10 <sup>-7</sup> (2.89x10 <sup>-7</sup> )	2.8x10 <sup>-7</sup> (1.42x10 <sup>-7</sup> )	9.4x10 <sup>-7</sup> (4.68x10 <sup>-7</sup> )
Total HxCdd	8.0x10 <sup>-7</sup> (3.99x10 <sup>-7</sup> )	5.6x10 <sup>-7</sup> (2.79x10 <sup>-7</sup> )	1.1x10 <sup>-6</sup> (5.66x10 <sup>-7</sup> )
Total HpCdd	1.1x10 <sup>-6</sup> (5.31x10 <sup>-7</sup> )	6.7x10 <sup>-7</sup> (3.33x10 <sup>-7</sup> )	1.5x10 <sup>-6</sup> (7.23x10 <sup>-7</sup> )
Total OCDD	3.6x10 <sup>-7</sup> (1.81x10 <sup>-7</sup> )	2.7x10 <sup>-7</sup> (1.37x10 <sup>-7</sup> )	5.1x10 <sup>-7</sup> (2.54x10 <sup>-7</sup> )
Total CDD	3.3x10 <sup>-6</sup> (1.67x10 <sup>-6</sup> )	2.0x10 <sup>-6</sup> (9.96x10 <sup>-7</sup> )	4.9x10 <sup>-6</sup> (2.44x10 <sup>-6</sup> )
<b>FURANS</b>			
2,3,7,8-TCDF	1.2x10 <sup>-7</sup> (5.89x10 <sup>-8</sup> )	6.3x10 <sup>-8</sup> (3.13x10 <sup>-8</sup> )	1.9x10 <sup>-7</sup> (9.38x10 <sup>-8</sup> )
Total TCDF	3.1x10 <sup>-6</sup> (1.53x10 <sup>-6</sup> )	2.0x10 <sup>-6</sup> (9.91x10 <sup>-7</sup> )	4.4x10 <sup>-6</sup> (2.19x10 <sup>-6</sup> )
Total PeCDF	3.0x10 <sup>-6</sup> (1.49x10 <sup>-6</sup> )	2.0x10 <sup>-6</sup> (1.00x10 <sup>-6</sup> )	4.1x10 <sup>-6</sup> (2.05x10 <sup>-6</sup> )
Total HxCDF	3.3x10 <sup>-6</sup> (1.67x10 <sup>-6</sup> )	3.0x10 <sup>-6</sup> (1.52x10 <sup>-6</sup> )	3.8x10 <sup>-6</sup> (1.90x10 <sup>-6</sup> )
Total HpCDF	2.2x10 <sup>-6</sup> (1.08x10 <sup>-6</sup> )	1.8x10 <sup>-6</sup> (8.79x10 <sup>-7</sup> )	2.6x10 <sup>-6</sup> (1.29x10 <sup>-6</sup> )
Total OCDF	3.8x10 <sup>-7</sup> (1.92x10 <sup>-7</sup> )	3.0x10 <sup>-7</sup> (1.50x10 <sup>-7</sup> )	5.3x10 <sup>-7</sup> (2.63x10 <sup>-7</sup> )
Total CDF	1.2x10 <sup>-5</sup> (6.02x10 <sup>-6</sup> )	9.2x10 <sup>-6</sup> (4.58x10 <sup>-6</sup> )	1.56x10 <sup>-5</sup> (7.81x10 <sup>-6</sup> )

Source: Reference 36.

<sup>a</sup> Uncontrolled; three test runs.

#### 4.2.1 Utility Sector

Utility boilers burn coal, oil, and natural gas to generate steam for electricity production. Most of the fossil fuel in the United States is consumed by the utility sector, with coal accounting for most of the fuel used, followed by natural gas and oil.<sup>37</sup> These sources generally have extremely low CDD/CDF emissions potential as the fuel used contains only small amounts of chlorinated compounds which can form CDD/CDF.

##### Process Description

Utility boilers are often identified by their furnace configuration and include tangentially-fired, wall-fired, cyclone-fired, and stoker-fired. The tangentially-fired boiler is based on the concept of a single flame zone within the furnace. The air-to-fuel mixture in a tangentially-fired boiler projects from the four corners of the furnace along a line tangential to an imaginary cylinder located along the furnace centerline. Tangentially-fired boilers commonly burn coal. However, oil or gas may also be burned. Wall-fired boilers are characterized by multiple individual burners located on a single wall or on opposing walls of the furnace. In contrast to tangentially-fired boilers that produce a single flame, each of the burners in a wall-fired boiler has a relatively distinct flare zone. Wall-fired boilers may burn coal, oil, or natural gas.

Cyclone-fired boilers burn crushed rather than pulverized coal. Fuel and air are burned in horizontal cylinders, producing a spinning high temperature flame. Cyclone-fired boilers are almost exclusively coal-fired. Stoker-fired boilers are mostly used at older plants. The most common stoker type is the spreader stoker. Spreader stokers are designed to feed solid fuel onto a grate within the furnace and remove ash residue. Spreader stokers are capable of burning all types of bituminous and lignite coals.

Fluidized bed combustion (FBC) is a newer boiler technology that is not as widely used as the other boiler types. In a typical FBC boiler, crushed coal in combination with inert

material (sand, silica, alumina, or ash) and/or sorbent (limestone) are maintained in a highly turbulent suspension by the upward flow of primary air from the windbox located directly below the combustor floor. This fluidization provides a large amount of surface contact between the air and solid particles, which promotes uniform and efficient combustion at low furnace temperatures, between 1,575 and 1,650°F (860 and 900°C) compared to 2,500 and 2,800°F (1,370 and 1,540°C) for conventional coal-fired boilers. Fluidized bed combustion boilers have been developed to operate at both atmospheric and pressurized conditions.<sup>16</sup>

### Emission Control Techniques

Baghouses, ESPs, wet scrubbers, and spray dryers have been applied in the utility sector. The temperature of "hot-side" ESP (located before the air preheater) of 370°C is such that downstream formation of CDD/CDF due to *de novo* synthesis of particulate matter may occur.

### Emission Factors

Emissions data based on boiler tests conducted over the past several years were obtained. Tables 4-11 and 4-12 contain draft CDD/CDF emission factors for coal-fired units and oil-fired units, respectively.<sup>38</sup> Detectable levels of CDD/CDF from gas-fired boilers were not identified. It is important to note that these data are preliminary and have not been approved and finalized by the EPA. In addition, the emission factors are for a composite of various furnace configurations and control devices. Thus, no SCCs or ratings were assigned to these data.

### Source Locations

There are approximately 700 known utility boilers located throughout the United States. Because of this large number of coal-fired sources, providing site-specific locations in this report is not practical.

TABLE 4-11. DRAFT SUMMARY OF CDD/CDF EMISSIONS FROM  
COMPOSITE COAL-FIRED UTILITY BOILERS<sup>a</sup>

Isomer	Median Emission Factor	
	lb/trillion Btu	g/MJ
2,3,7,8-TCDD	1.6x10 <sup>-6</sup>	6.9x10 <sup>-13</sup>
1,2,3,7,8-PeCDD	4.3x10 <sup>-6</sup>	1.8x10 <sup>-12</sup>
1,2,3,4,7,8-HxCDD	9.7x10 <sup>-6</sup>	4.2x10 <sup>-12</sup>
1,2,3,6,7,8-HxCDD	5.8x10 <sup>-6</sup>	2.5x10 <sup>-12</sup>
1,2,3,7,8,9-HxCDD	7.3x10 <sup>-6</sup>	3.1x10 <sup>-12</sup>
1,2,3,4,6,7,8-HpCDD	5.7x10 <sup>-6</sup>	2.5x10 <sup>-12</sup>
Total HpCDD	1.1x10 <sup>-4</sup>	4.7x10 <sup>-11</sup>
Total HxCDD	2.4x10 <sup>-5</sup>	1.0x10 <sup>-11</sup>
Total OCDD	5.8x10 <sup>-5</sup>	2.5x10 <sup>-11</sup>
Total PeCDD	9.8x10 <sup>-6</sup>	4.2x10 <sup>-12</sup>
Total TCDD	7.1x10 <sup>-6</sup>	3.1x10 <sup>-12</sup>
Total CDD	2.1x10 <sup>-4</sup>	8.9x10 <sup>-11</sup>
2,3,7,8-TCDF	3.9x10 <sup>-6</sup>	1.7x10 <sup>-12</sup>
1,2,3,7,8-PeCDF	2.4x10 <sup>-6</sup>	1.0x10 <sup>-12</sup>
2,3,4,7,8-PeCDF	1.0x10 <sup>-5</sup>	4.3x10 <sup>-12</sup>
1,2,3,4,7,8-HxCDF	1.3x10 <sup>-5</sup>	5.6x10 <sup>-12</sup>
1,2,3,6,7,8-HxCDF	4.0x10 <sup>-6</sup>	1.7x10 <sup>-12</sup>
1,2,3,7,8,9-HxCDF	8.5x10 <sup>-6</sup>	3.7x10 <sup>-12</sup>
2,3,4,6,7,8-HxCDF	1.6x10 <sup>-5</sup>	6.9x10 <sup>-12</sup>
1,2,3,4,6,7,8-HpCDF	2.0x10 <sup>-5</sup>	8.6x10 <sup>-12</sup>
1,2,3,4,7,8,9-HpCDF	1.7x10 <sup>-4</sup>	7.3x10 <sup>-11</sup>
Total HpCDF	2.4x10 <sup>-5</sup>	1.0x10 <sup>-11</sup>
Total HxCDF	1.9x10 <sup>-5</sup>	8.2x10 <sup>-12</sup>
Total OCDF	1.7x10 <sup>-5</sup>	7.3x10 <sup>-12</sup>
Total PeCDF	1.8x10 <sup>-5</sup>	7.7x10 <sup>-12</sup>
Total TCDF	1.2x10 <sup>-5</sup>	5.2x10 <sup>-12</sup>
Total CDF	9.0x10 <sup>-5</sup>	3.8x10 <sup>-11</sup>

Source: Reference 38.

TABLE 4-12. DRAFT SUMMARY OF CDD/CDF EMISSIONS FROM  
COMPOSITE OIL-FIRED UTILITY BOILERS<sup>a</sup>

Isomer	Median Emission Factor	
	lb/trillion Btu	g/MJ
2,3,7,8-TCDD	6.5x10 <sup>-6</sup>	2.8x10 <sup>-12</sup>
1,2,3,7,8-PeCDD	5.8x10 <sup>-6</sup>	2.5x10 <sup>-12</sup>
1,2,3,4,7,8-HxCDD	1.2x10 <sup>-5</sup>	5.2x10 <sup>-12</sup>
1,2,3,6,7,8-HxCDD	5.4x10 <sup>-6</sup>	2.3x10 <sup>-12</sup>
1,2,3,7,8,9-HxCDD	8.3x10 <sup>-6</sup>	3.6x10 <sup>-12</sup>
1,2,3,4,6,7,8-HpCDD	2.0x10 <sup>-5</sup>	8.6x10 <sup>-12</sup>
Total HpCDD	2.0x10 <sup>-5</sup>	8.6x10 <sup>-12</sup>
Total HxCDD	8.1x10 <sup>-6</sup>	3.5x10 <sup>-12</sup>
Total OCDD	2.3x10 <sup>-5</sup>	9.9x10 <sup>-12</sup>
Total PeCDD	5.8x10 <sup>-6</sup>	2.5x10 <sup>-12</sup>
Total TCDD	5.7x10 <sup>-6</sup>	2.5x10 <sup>-12</sup>
Total CDD	6.3x10 <sup>-5</sup>	2.7x10 <sup>-11</sup>
2,3,7,8-TCDF	4.6x10 <sup>-6</sup>	2.0x10 <sup>-12</sup>
1,2,3,7,8-PeCDF	4.3x10 <sup>-6</sup>	1.8x10 <sup>-12</sup>
2,3,4,7,8-PeCDF	4.8x10 <sup>-6</sup>	2.1x10 <sup>-12</sup>
1,2,3,4,7,8-HxCDF	6.1x10 <sup>-6</sup>	2.6x10 <sup>-12</sup>
1,2,3,6,7,8-HxCDF	3.8x10 <sup>-6</sup>	1.6x10 <sup>-12</sup>
1,2,3,7,8,9-HxCDF	5.8x10 <sup>-6</sup>	2.5x10 <sup>-12</sup>
2,3,4,6,7,8-HxCDF	4.8x10 <sup>-6</sup>	2.1x10 <sup>-12</sup>
1,2,3,4,6,7,8-HpCDF	9.4x10 <sup>-6</sup>	4.0x10 <sup>-12</sup>
1,2,3,4,7,8,9-HpCDF	1.0x10 <sup>-5</sup>	4.3x10 <sup>-12</sup>
Total HpCDF	1.5x10 <sup>-6</sup>	6.5x10 <sup>-13</sup>
Total HxCDF	9.6x10 <sup>-6</sup>	4.1x10 <sup>-12</sup>
Total OCDF	1.0x10 <sup>-5</sup>	4.3x10 <sup>-12</sup>
Total PeCDF	7.3x10 <sup>-6</sup>	3.1x10 <sup>-12</sup>
Total TCDF	5.0x10 <sup>-6</sup>	2.2x10 <sup>-12</sup>
Total CDF	3.3x10 <sup>-5</sup>	1.4x10 <sup>-11</sup>

Source: Reference 38.

Information on precise utility plant locations can be obtained by contacting utility trade associations such as the Electric Power Research Institute in Palo Alto, California (415-855-2000); the Edison Electric Institute in Washington, D.C. (202-828-7400); or the U.S. Department of Energy (DOE) in Washington, D.C. Publications by EPA and the DOE on the utility industry also would be useful in determining specific facility locations, sizes, and fuel use.

#### 4.2.2 Industrial Sector

Industrial boilers are widely used in manufacturing, processing, mining, and refining, primarily to generate process steam and provide space heating. Some boilers are also used for electricity generation. Industrial boilers can fire fossil and non-fossil fuels. Wood is the only non-fossil fuel discussed here, since wood-fired industrial boilers are more likely sources of CDD/CDF emissions due to the presence of CDD/CDF precursors in wood.

##### Process Description

Industrial boilers burning fossil fuels are identified by their heat transfer method. These include watertube, firetube, and cast iron. Watertube boilers are designed to pass water through the inside of heat transfer tubes while the outside of the tubes is heated by direct contact with the hot combustion gases. Industrial watertube boilers can burn coal, oil, or natural gas. Coal-fired industrial boilers are generally of the watertube design. Firing mechanisms include pulverized coal and stoker (spreader, underfeed, and overfeed stoker). The most common of these are pulverized coal boilers, especially for larger coal-fired boilers. In firetube boilers, the hot gas flows through the tubes and the water being heated circulates outside of the tubes. Most installed firetube boilers burn oil or gas. In cast iron boilers, the hot gas is contained inside the tubes and the water being heated circulates outside the tubes.



The burning of wood waste in boilers is mostly confined to those industries where it is available as a byproduct. Currently, the bulk of wood residue or bark burning in industrial boilers is carried out in forest products industrial boilers.<sup>39</sup> It is burned both to obtain heat energy and to alleviate solid waste disposal problems. The bulk of wood combusted is from debarking of logs or byproducts from wood products operations where the original wood is not tainted with inorganic chlorides such as would be the case with logs stored or transported over sea water. CDD/CDF emissions from facilities burning salt-laden wood residue may be considerably higher than from those burning salt-free wood residues, and are not considered here. Wood waste may include large pieces, such as slabs, logs, and bark strips, as well as cuttings, shavings, pellets, and sawdust.<sup>40</sup>

Various boiler firing configurations are used in burning wood waste. One common type in smaller operations is the dutch oven or extension type of furnace with a flat grate (see Figures 4-12 and 4-13). This unit is widely used because it can burn fuels with very high moisture. Fuel is fed into the oven through apertures in a firebox and is fired in a cone-shaped pile on a flat grate. The burning is done in two stages: (1) drying and gasification, and (2) combustion of gaseous products. The first stage takes place in a cell separated from the boiler section by a bridge wall. The combustion stage takes place in the main boiler section.<sup>39,40</sup>

In another type of boiler, the fuel-cell oven, fuel is dropped onto suspended fixed grates and is fired in a pile. The fuel cell further uses combustion air preheating and repositioning of the secondary and tertiary air injection ports to improve boiler efficiency.<sup>40</sup>

In many large operations, more conventional boilers have been modified to burn wood waste. These units may include spreader stokers with traveling grates or vibrating grate stokers, as well as tangentially fired or cyclone-fired boilers. The most widely used of these configurations is the spreader stoker, which can burn dry or wet wood. Fuel is dropped in front of an air jet, which casts the fuel over a moving grate. The burning is done in three stages: (1) drying; (2) distillation and burning of volatile matter; and (3) burning of residual carbon.<sup>39</sup>

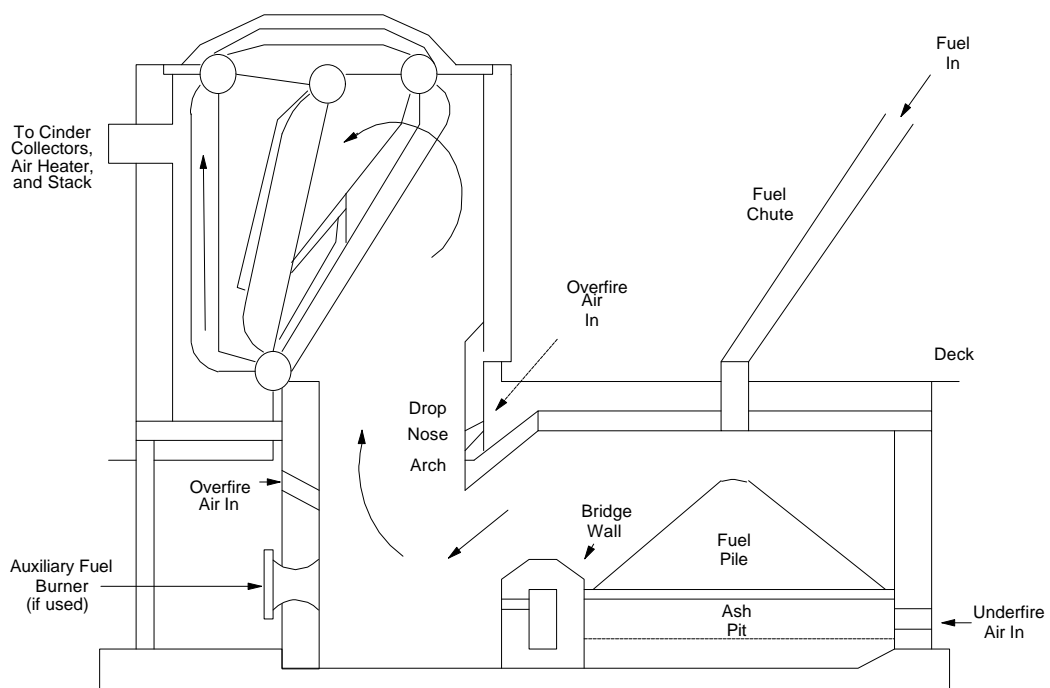

Figure 4-12. One-Cell Dutch Oven-Type Boiler

Source: Reference 40.

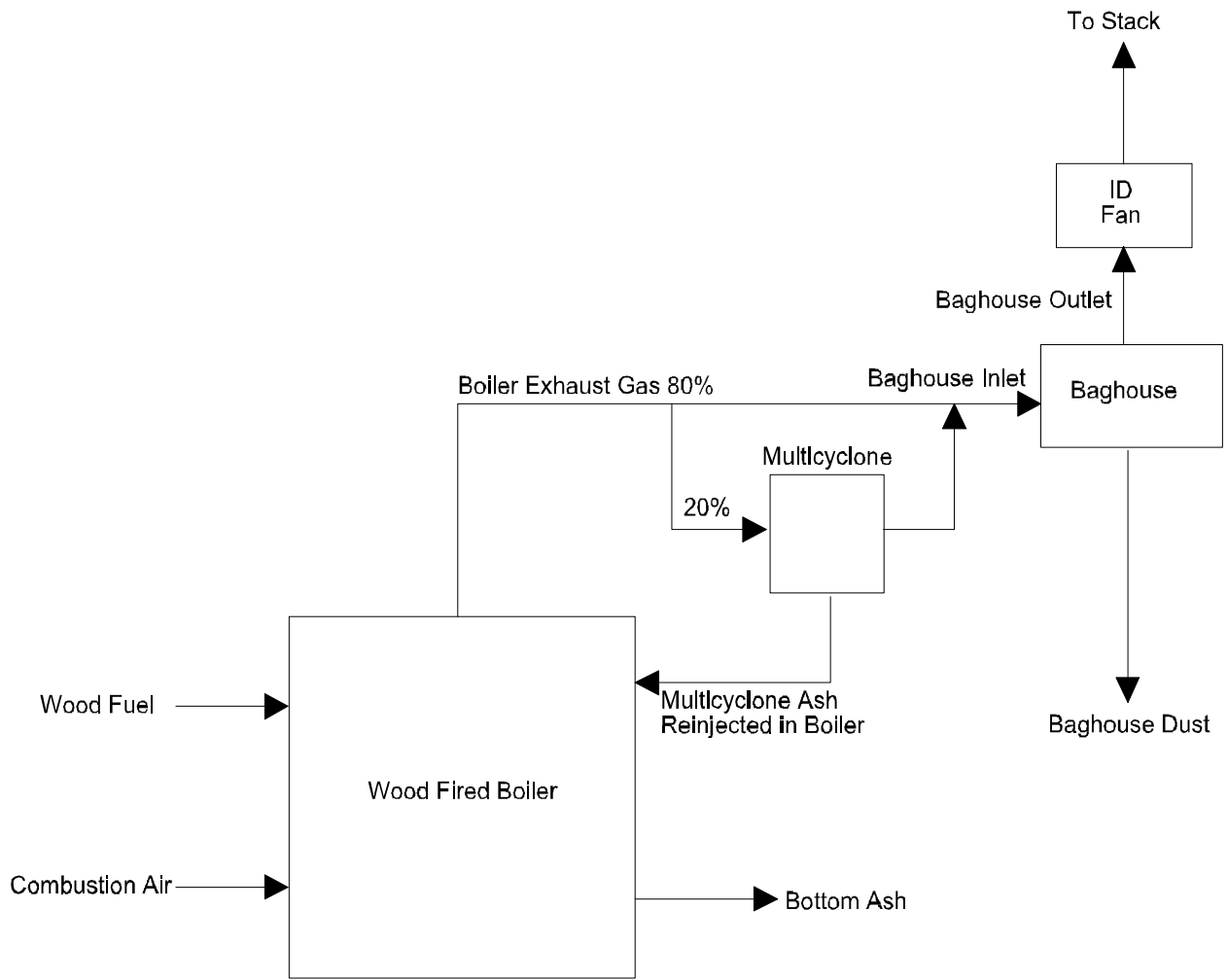

Figure 4-13. Schematic Process Flow for Dutch Oven Boiler

Source: Reference 40.

Sander dust is often burned in various boiler types at plywood, particle board, and furniture plants. Sander dust contains fine wood particles with low moisture content (less than 20 percent by weight). In some boilers, it is fired through a flaming horizontal torch, usually with natural gas as an ignition aid or supplementary fuel.<sup>40</sup>

A recent development in wood-firing is FBC boilers. Refer to Section 4.2.1, Utility Sector, for a description of this boiler-type. Because of the large thermal mass represented by the hot inert bed particles, FBCs can handle fuels with high moisture content (up to 70 percent, total basis). Fluidized beds can also handle dirty fuels (up to 30 percent inert material). Wood is pyrolyzed faster in a fluidized bed than on a grate due to its immediate contact with hot bed material. As a result, combustion is rapid and results in nearly complete combustion of organic matter, thereby minimizing emission of unburned organic compounds.<sup>40</sup>

Emissions of CDD/CDF from wood-fired boilers are dependent on several variables: (1) wood waste composition and variability; (2) fossil fuel type and quantity, if any, co-fired with the wood waste; (3) combustor type and performance; and (4) air pollution control systems.

The composition of wood waste has an impact on CDD/CDF emissions. The composition of wood waste depends largely on the industry from which it originates. Pulping operations, for example, produce great quantities of bark that may contain more than 70 percent by weight moisture, along with sand and other noncombustibles. Because of this, bark boilers in pulp mills may emit considerable amounts of organic compounds to the atmosphere unless they are well controlled. On the other hand, some operations, such as furniture manufacturing, produce a clean, dry wood waste, 5 to 50 percent by weight moisture, with relatively low particulate emissions when properly burned. Still other operations, such as sawmills, burn a varying mixture of bark and wood waste that results in particulate emissions somewhere between those of pulp mills and furniture manufacturing. Additionally, when fossil fuels are co-fired with

wood waste, the combustion efficiency is typically improved; therefore, organic emissions may decrease.

Combustor performance, especially the ability to provide ample air and fuel mixing and to maintain adequate temperatures for hydrocarbon destruction, are critical to minimizing emissions of CDD/CDF and precursor compounds. Key combustor design and operating parameters are ample time and temperature for drying high moisture content materials, and adequate supply and proper placement of undergrate and overfire combustion air. If the requirements are satisfied, the potential for emission of CDD/CDF is significantly reduced.

#### Emission Control Techniques

Emissions controls for fossil fuel-fired industrial boilers are similar to those previously described for coal-fired utility boilers. Traditionally, control devices on wood-fired boilers were intended primarily for particulate control. Mechanical collectors such as multicyclones were most often used, especially on stoker-fired industrial boilers, to capture large, partially burned material and reinject it to the boiler. These devices, however, do not meet the current New Source Performance Standard for wood-fired boilers. Thus, for wood-fired utility boilers, these multicyclones are often used in conjunction with secondary dust collectors, including ESPs, wet scrubbers, or fabric filters.<sup>39,40</sup> Scrubbers are most commonly venturi, although, impingement wet scrubbers are also used.

On the West Coast, fabric filters are primarily used to collect chloride fumes in boilers combusting salt-laden bark.<sup>39</sup> Some gravel-bed filters have been used in lieu of fabric filters to eliminate fabric fire hazards. Only limited numbers of wood-fired boilers use ESPs for control because they are less effective at collecting high-carbon ash. Some boilers may require additional controls for nitrogen oxides and acid gas. Acid gas removal techniques, such as using limestone scrubbers, are often needed for boilers burning demolition debris and other chloride-containing fuels.<sup>39</sup>

Several recent studies indicate that CDD/CDF emissions may increase across fabric filters, wet scrubbers, and ESPs. This may be caused by low-temperature de novo synthesis, or a transformation reaction of CDD/CDF in the air pollution control equipment.

#### Emission Factors

The U.S. EPA reports emission factors (in AP-42) for wood waste combustion for total CDD/CDF developed from several test reports. One test was conducted on a Wellons Quad Cell wood-fired boiler used for generating electricity. This boiler was tested under normal steady-state operating conditions of 60,000 lb (27,216 kg) of steam per hour and 5 MW electricity. The fuel consisted of coarse wood waste and coarse sawdust from non-industrial logging operations. The exhaust gas stream from the boiler passed through a multicyclone before entering the stack where CDD/CDF was sampled. In another study, speciated CDD/CDF data were reported from a test conducted on a wood-fired boiler exhaust in 1992. The boiler, firing wood/bark waste, was equipped with a scrubber and produced less than 50,000 lb (22,680 kg) steam. These data are presented in Table 4-13.<sup>40</sup> Because the data are from only two tests and one of the boilers tested was a utility boiler, it is not possible to conclude that the emission factors presented in Table 4-13 are representative of the category.

TABLE 4-13. TOTAL CDD/CDF EMISSION FACTORS FROM  
WOOD WASTE COMBUSTION  
SCC 1-01-009-01/02/03, 1-02-009-01 through -07, 1-03-009-01/02/03  
(Utility, Industrial, and Commercial/Institutional Boilers)

Isomer	Average Emission Factor		Factor Quality Rating
	lb/ton wood waste burned	kg/Mg wood waste burned	
Total CDD	1.2x10 <sup>-8</sup>	6.0x10 <sup>-9</sup>	C
Total CDF	2.9x10 <sup>-8</sup>	1.5x10 <sup>-8</sup>	C
2,3,7,8-TCDD	3.6x10 <sup>-11</sup>	1.8x10 <sup>-11</sup>	D

Source: Reference 40.

The National Council of the Paper Industry for Air and Stream Improvement Inc. (NCASI), recently summarized CDD/CDF levels measured from four industrial sources burning wood residue and/or bark.<sup>41</sup> All TEFs reported are based on the I-TEF/89 scheme, which has been adopted by EPA for assessing the risks associated with CDD/CDF exposure.

The four wood-fired boilers tested ranged in size from  $30 \times 10^3$  to  $209 \times 10^3$  lb/hr ( $1.4 \times 10^4$  to  $9.5 \times 10^4$  kg/hr) steam production capacity. One boiler was operated at a steady rate of  $60 \times 10^3$  lb ( $2.7 \times 10^4$  kg) steam/hr during the tests and burned wood waste and sawdust in a Wellons Quad Cell. This boiler is the same unit as described above and included in the emission factors presented in AP-42 for total CDD/CDF from wood residue combustion. The exhaust gases passed through a multicyclone before exiting through the stack. The second boiler tested was also a Wellons Quad Cell operating between  $30 \times 10^3$  to  $60 \times 10^3$  lb ( $1.4 \times 10^4$  to  $2.7 \times 10^4$  kg) steam/hr and burning wood chips and bark. The flue gases passed through a multicyclone and an ESP before entering the stack.

The third boiler tested was a fluidized bed combustor. It operated at  $209 \times 10^3$  lb ( $9.5 \times 10^4$  kg) steam/hr and burned wood and agricultural waste. Air pollution control techniques on this unit were vaporized ammonia injection for  $\text{NO}_x$  control, a multicyclone, and an ESP. The fourth boiler tested had two parallel spreader stokers. At test conditions, each boiler burned wood waste and produced  $110 \times 10^3$  lb ( $5.0 \times 10^4$  kg) steam/hr. The exhaust gases from each boiler passed through its own dedicated ESP, and then through a common stack.<sup>41</sup>

NCASI also reported data from another study that tested five pulp and paper industry boilers firing bark, wood residue, or a combination of these two fuels. During testing, the boilers operated between  $320 \times 10^3$  to  $600 \times 10^3$  lb ( $1.4 \times 10^5$  to  $2.7 \times 10^5$  kg) steam/hr.

Table 4-14 provides a summary of the average CDD/CDF emissions (in TEQ units) from the nine boilers tested and described above. It should be noted that accurate estimates of the amount of bark or wood residue fired were not measured during the tests. However,

TABLE 4-14. SUMMARY OF TOTAL CDD/CDF EMISSIONS FROM INDUSTRIAL WOOD  
RESIDUE-FIRED BOILERS

Unit ID	WFBA <sup>a,b</sup>	WFBB <sup>c,d</sup>	WFBC <sup>d,e</sup>	WFBD <sup>d,f</sup>	CBA <sup>b,g</sup>	WFBE <sup>b,g</sup>	WFBF <sup>d,g</sup>	CFB#5 <sup>d,f</sup>	CBF#4 <sup>d,f</sup>	Average	Max	Min
I-TEF TEQ, lb/dscf (ng/dscm)	1.3x10 <sup>-14</sup> (2.1x10 <sup>-1</sup> )	7.5x10 <sup>-15</sup> (1.2x10 <sup>-1</sup> )	1.5x10 <sup>-14</sup> (2.4x10 <sup>-1</sup> )	1.6x10 <sup>-14</sup> (2.5x10 <sup>-1</sup> )	1.8x10 <sup>-14</sup> (2.8x10 <sup>-1</sup> )	2.8x10 <sup>-17</sup> (4.4x10 <sup>-4</sup> )	6.2x10 <sup>-17</sup> (9.9x10 <sup>-4</sup> )	2.4x10 <sup>-15</sup> (3.8x10 <sup>-2</sup> )	9.4x10 <sup>-15</sup> (1.5x10 <sup>-1</sup> )	8.7x10 <sup>-15</sup> (1.4x10 <sup>-1</sup> )	1.8x10 <sup>-14</sup> (2.8x10 <sup>-1</sup> )	2.8x10 <sup>-17</sup> (4.4x10 <sup>-4</sup> )
I-TEF TEQ, lb/ton (µg/kg) wood <sup>h</sup>										1.2x10 <sup>-9</sup> (6.2x10 <sup>-4</sup> )	2.4x10 <sup>-9</sup> (1.2x10 <sup>-3</sup> )	3.8x10 <sup>-12</sup> (1.9x10 <sup>-6</sup> )

Source: Reference 41.

4-70

Note: All results were reported at 12 percent CO<sub>2</sub>. Unit IDs are confidential identification codes for the mills, boilers, and units tested.

a Fuel = wood waste and sawdust.

b Final control device = multicyclone.

c Fuel = wood chips and bark.

d Final control device = ESP.

e Fuel = wood and agriculture waste.

f Fuel = wood waste only.

g Fuel = 100 percent bark.

h Assuming 1,850 scf CO<sub>2</sub> per million Btu, 9,000 Btu/lb dry wood, and 50 percent wood moisture.



NCASI used an average F factor and an average heat content value for wood combustion to convert concentrations to emission factors. An F factor is the ratio of the gas volume of the products of combustion to the heat content of the fuel. Using an F factor of 1,850 standard cubic feet (scf) CO<sub>2</sub>/MMBtu and a heat value of 9,000 Btu/lb dry wood residue (or bark), an average industrial wood combustion emission factor of 1.2x10<sup>-3</sup> μg TEQ/kg dry fuel was obtained.<sup>41</sup> The typical moisture content of bark/wood residue is about 50 percent. Thus, an average emission factor on an as-fired basis of 6.2x10<sup>-4</sup> μg TEQ/kg as-fired wood residue is obtained.<sup>41</sup>

#### Bleached Kraft Mill Sludge Burning in Wood-Fired Boilers

Primary and secondary sludges from pulp mills are increasingly dewatered and burned in industrial bark boilers.<sup>41</sup> The sludge from mills with bleaching operations can contain fairly significant levels of chloride. The concern exists that CDD/CDF emissions will increase significantly from the addition of bleached kraft mill (BKM) sludge to the bark or wood residue fuel. NCASI reports emissions data from three tests of a spreader stoker boiler equipped with an ESP, burning BKM sludge with the wood residue. Results from a second test are also reported where bark and coal were burned in a spreader stoker with small amounts of BKM sludge. The results of these two tests suggest that the burning of BKM sludge has little impact on CDD/CDF emissions from wood combustion.<sup>41</sup> Table 4-15 presents the average emissions data from these tests.

TABLE 4-15. TOTAL CDD/CDF EMISSIONS FROM A WOOD-FIRED BOILER WHILE BURNING BLEACHED KRAFT MILL SLUDGE<sup>a</sup>

	Average Emissions at 12% CO <sub>2</sub>	
	lb/dscf	ng/dscm
I-TEF TEQ	8.7x10 <sup>-18</sup>	1.4x10 <sup>-4</sup>
I-TEF TEQ <sup>b</sup>	1.3x10 <sup>-15</sup>	2.1x10 <sup>-2</sup>

Source: Reference 41.

<sup>a</sup> Spreader stoker equipped with an ESP; Test date, November 1993.

<sup>b</sup> Fired with coal, wood residue, and BKM sludge.

## Source Locations

Most of the coal-fired industrial boiler sources are located in the Midwest, Appalachian, and Southeast regions. Industrial wood-fired boilers tend to be located almost exclusively at pulp and paper, lumber products, and furniture industry facilities. These industries are concentrated in the Southeast, Gulf Coast, Appalachian, and Pacific Northwest regions. The Pacific Northwest contains many of the boilers firing salt-laden wood bark. As of 1980, there were approximately 1,600 wood-fired boilers operating in the United States, with a total capacity of over 30,000 megawatts (MW).<sup>40</sup>

Trade associations such as the American Boiler Manufacturers Association in Arlington, Virginia (703-522-7350) and the Council of Industrial Boiler Owners in Fairfax Station, Virginia (703-250-9042) can provide information on industrial boiler locations and trends.

### 4.2.3 Residential Sector

The residential sector includes furnaces, stoves, and fireplaces burning coal, oil, gas, and wood to produce heat for individual homes. Residential coal-fired furnaces are usually underfeed hand-stoked units, while oil-fired furnaces are designed with varying burner configurations. Emission factors are presented in this section for both of these sources. Gas-fired furnaces, which are unlikely sources of CDD/CDF, are not included here.

Residential wood combustion devices include furnaces, fireplaces, and woodstoves. Furnaces firing wood are similar in design and operation to those burning coal. Fireplaces are used primarily for supplemental heating and for aesthetic effects. Energy efficiencies of prefabricated fireplaces are slightly higher than those of masonry fireplaces.<sup>42</sup>

The combustion of fossil fuels or wood in residential units (woodstoves, furnaces, fireplaces) is a relatively slow and low-temperature process. Because combustion in the residential sector tends to be less efficient than in other sectors, the potential to form CDD/CDF may be greater. Also, inadequate maintenance of these units may increase potential for CDD/CDF formation on particulate matter. Furthermore, residential combustion units are generally not equipped with gaseous or particulate control devices.

### Process Description

In the residential sector, coal is usually combusted in underfeed or hand-stoked furnaces. Stoker fed units are the most common design for warm-air furnaces and for boilers used for steam or hot water production. These units are typically controlled with an automatic thermostat and designed for a specific type of coal. Other coal-fired heating units include hand-fed room heaters, metal stoves, and metal and masonry fireplaces. Most of the coal combusted in all of these units is either bituminous or anthracite.<sup>14,43</sup> These units operate at low temperatures and do not efficiently combust fuel. Generally, coal contains small quantities of chlorine and CDD/CDF precursors. Therefore, the potential for CDD/CDF formation exists.

Oil-fired residential furnaces are designed with varying burner configurations, each attempting to optimize fuel combustion efficiency. Emissions from fuel oil combustion depend on the grade and composition of the oil, the design of the furnace, and the level of equipment maintenance.

Important fuel oil combustion properties include pumpability, heating value, and ash content. Lighter grade oils are more easily atomized and generally exhibit better combustion properties than heavier grade oils.<sup>44</sup> Both furnace design and equipment maintenance influence combustion efficiency. Particulate matter emissions depend most on the ash content and grade of oil fired, with lighter grade oils exhibiting lower emissions. Oil contains only small amounts of chlorine and CDD/CDF precursors.

Woodstoves are used commonly in residences as space heaters to supplement conventional heating systems. Woodstoves transfer heat by radiation from the hot stove walls to the room. Circulating stoves convert radiant energy to warm convection air. Combustion efficiencies for woodstoves are dependent on stove design and operating characteristics. Consequently, combustion efficiency and emissions vary greatly among woodstoves. For purposes of estimating emissions, woodstoves are classified into four categories: conventional woodstoves, noncatalytic woodstoves, pellet stoves, and catalytic woodstoves. These categories are based on fuel type and emission reduction features.<sup>14,42</sup> Woodstoves have a greater potential to emit CDD/CDF than fossil fuel-fired units due to the presence of CDD/CDF precursors present in wood. Figure 4-14 depicts a typical noncatalytic woodstove.

#### Emission Control Techniques

As mentioned previously, residential combustion sources do not generally use air pollution control devices. The effect of controls that are used on CDD/CDF emissions has not been studied.

Coal-fired residential combustion sources are generally not equipped with PM or gaseous pollutant control devices. Changes in stove design and operating practices, however, have been made to effect lower PM, hydrocarbon, and CO emissions. Changes include modified combustion air flow control, better thermal control and heat storage, and the use of combustion catalysts.<sup>14</sup>

Residential oil- and wood-fired furnaces are not equipped with pollution control equipment. Residential fireplaces do not typically employ control devices.

Wood stove emissions reduction features include baffles, secondary combustion chambers, and catalytic combustors. Catalytic combustors or convertors are similar to those used in automobiles. Wood stove control devices may lose efficiency over time. Control degradation

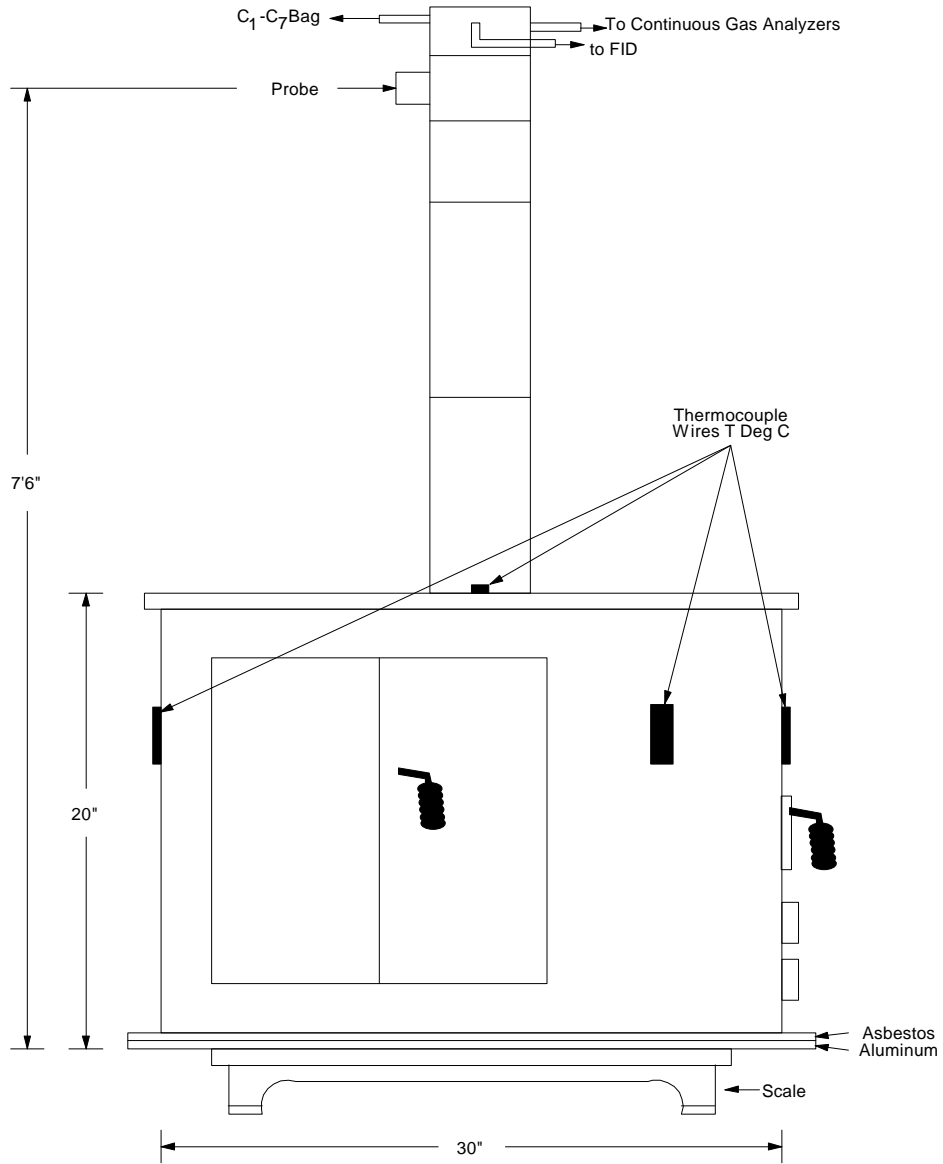

Figure 4-14. Simplified Diagram of a Freestanding Noncatalytic Woodstove

Source: Reference 42.

for any stoves, including noncatalytic woodstoves, may occur as a result of deteriorated seals and gaskets, misaligned baffles and bypass mechanisms, broken refractories, or other damaged functional components.<sup>42</sup> In addition, combustion efficiencies may be affected by differences in the sealing of the chamber and control of the intake and exhaust systems.<sup>14,43</sup>

### Emission Factors

Emission factors for coal-fired residential furnaces are presented in Table 4-16.<sup>43</sup> These emission factors are based on average particulate CDD/CDF concentrations from chimney soot samples collected from 7 coal stoves, and particulate emission factors obtained from AP-42.<sup>42,44</sup> These emission factors represent the maximum emission rates from these sources, as chimney soot may not be representative of the particulate actually emitted to the atmosphere.

Emission factors for oil-fired residential furnaces are presented in Table 4-17. These emission factors are based on average CDD/CDF concentrations in soot measured from 21 furnaces used in central heating, and particulate emission rates obtained from AP-42.<sup>43,45</sup>

Emission factors for a residential wood stove, fireplace, and furnace are presented in Table 4-18. These emission factors are based on average CDD/CDF concentrations in soot measured at 18 combustion unit chimneys, and particulate emission rates obtained from AP-42.<sup>43</sup> These emission factors represent the maximum emission rates from these sources, as chimney soot may not be representative of the particulate actually emitted to the atmosphere.

In one study, an Atlanta Stove Works freestanding noncatalytic woodstove, depicted in Figure 4-14, was sampled. The stove combusted oak and pine aged for one year. The stove was operated at low burn rates and low operating temperatures for maximum wood-use efficiency, which is representative of normal residential use. Burn rates for individual test runs ranged from 2.9 to 7.7 lb/hr (1.3 to 3.5 kg/hr).<sup>47</sup> Sampling for CDD/CDF emissions was performed at the outlet exhaust stack in each of a series of three test runs. However, no valid flue

TABLE 4-16. CDD/CDF EMISSION FACTORS FOR COAL-FIRED  
RESIDENTIAL FURNACES  
FACTOR QUALITY RATING: U

Isomer	Coal Furnaces <sup>a</sup>	
	lb/ton coal burned (mg/Mg coal burned)	
	Anthracite (AMS Code 21-04-001-000)	Bituminous (AMS Code 21-04-002-000)
<b>DIOXINS</b>		
2,3,7,8-TCDD	3.2x10 <sup>-9</sup> (1.6x10 <sup>-3</sup> )	4.8x10 <sup>-9</sup> (2.4x10 <sup>-3</sup> )
Total Other TCDD	1.2x10 <sup>-7</sup> (6.0x10 <sup>-2</sup> )	1.8x10 <sup>-7</sup> (9.0x10 <sup>-2</sup> )
Total PeCDD	6.2x10 <sup>-8</sup> (3.1x10 <sup>-2</sup> )	9.2x10 <sup>-8</sup> (4.6x10 <sup>-2</sup> )
Total HxCDD	1.2x10 <sup>-7</sup> (6.0x10 <sup>-2</sup> )	1.8x10 <sup>-7</sup> (9.0x10 <sup>-2</sup> )
Total HpCDD	1.1x10 <sup>-7</sup> (5.7x10 <sup>-2</sup> )	1.7x10 <sup>-7</sup> (8.6x10 <sup>-2</sup> )
Total OCDD	1.5x10 <sup>-7</sup> (7.7x10 <sup>-2</sup> )	2.4x10 <sup>-7</sup> (1.2x10 <sup>-1</sup> )
Total CDD	5.6x10 <sup>-7</sup> (2.9x10 <sup>-1</sup> )	8.7x10 <sup>-7</sup> (4.3x10 <sup>-1</sup> )
<b>FURANS</b>		
2,3,7,8-TCDF	8.4x10 <sup>-8</sup> (4.2x10 <sup>-2</sup> )	1.3x10 <sup>-7</sup> (6.3x10 <sup>-2</sup> )
Total Other TCDF	7.4x10 <sup>-7</sup> (3.7x10 <sup>-1</sup> )	1.1x10 <sup>-6</sup> (5.5x10 <sup>-1</sup> )
Total PeCDF	6.8x10 <sup>-7</sup> (3.4x10 <sup>-1</sup> )	1.1x10 <sup>-6</sup> (5.5x10 <sup>-1</sup> )
Total HxCDF	2.6x10 <sup>-7</sup> (1.3x10 <sup>-1</sup> )	3.8x10 <sup>-7</sup> (1.9x10 <sup>-1</sup> )
Total HpCDF	6.4x10 <sup>-8</sup> (3.2x10 <sup>-2</sup> )	9.4x10 <sup>-8</sup> (4.7x10 <sup>-2</sup> )
Total OCDF	8.4x10 <sup>-9</sup> (4.2x10 <sup>-3</sup> )	1.3x10 <sup>-8</sup> (6.3x10 <sup>-3</sup> )
Total CDF	1.8x10 <sup>-6</sup> (9.2x10 <sup>-1</sup> )	2.8x10 <sup>-6</sup> (1.41)

Source: Reference 43.

<sup>a</sup> Based on CDD/CDF particulate concentrations and particulate emission factors from AP-42 as follows:

<u>Fuel</u>	<u>Emission Factor</u>
anthracite	11.0 lb/ton (5.5x10 <sup>6</sup> mg/Mg)
bituminous	16.5 lb/ton (8.2x10 <sup>6</sup> mg/Mg)

TABLE 4-17. CDD/CDF EMISSION FACTORS FOR OIL-FIRED  
RESIDENTIAL FURNACES  
AMS 21-04-004-000, 21-04-005-000  
FACTOR QUALITY RATING: U

Isomer	Oil Central Heating <sup>a</sup>	
	lb/gal	mg/L
<b>DIOXINS</b>		
2,3,7,8-TCDD	4.7x10 <sup>-13</sup>	5.6x10 <sup>-8</sup>
Total Other TCDD	6.9x10 <sup>-13</sup>	8.3x10 <sup>-8</sup>
Total PeCDD	6.8x10 <sup>-13</sup>	8.2x10 <sup>-8</sup>
Total HxCDD	5.5x10 <sup>-13</sup>	6.6x10 <sup>-8</sup>
Total HpCDD	5.3x10 <sup>-13</sup>	6.3x10 <sup>-8</sup>
Total OCDD	5.5x10 <sup>-13</sup>	6.6x10 <sup>-8</sup>
Total CDD	3.5x10 <sup>-12</sup>	4.2x10 <sup>-7</sup>
<b>FURANS</b>		
2,3,7,8-TCDF	4.4x10 <sup>-13</sup>	5.3x10 <sup>-8</sup>
Total Other TCDF	5.1x10 <sup>-12</sup>	6.1x10 <sup>-7</sup>
Total PeCDF	3.5x10 <sup>-12</sup>	4.2x10 <sup>-7</sup>
Total HxCDF	1.4x10 <sup>-12</sup>	1.7x10 <sup>-7</sup>
Total HpCDF	6.1x10 <sup>-13</sup>	7.3x10 <sup>-8</sup>
Total OCDF	2.5x10 <sup>-13</sup>	3.0x10 <sup>-8</sup>
Total CDF	1.1x10 <sup>-11</sup>	1.4x10 <sup>-6</sup>

Source: Reference 43.

<sup>a</sup> Based on particulate CDD/CDF concentrations and particulate emission factors from AP-42 as follows:

<u>Fuel</u>	<u>Emission Factor</u>
oil	2.5x10 <sup>-3</sup> lb/gal (3.0x10 <sup>2</sup> mg/L)



TABLE 4-18. AVERAGE CDD/CDF EMISSION FACTORS FOR WOOD-FIRED RESIDENTIAL COMBUSTORS  
FACTOR QUALITY RATING: U

Isomer	Wood Stove <sup>a</sup> (AMS Code 21-04-008-010) lb/ton (mg/Mg) wood burned	Fireplace <sup>a</sup> (AMS Code 21-04-008-001) lb/ton (mg/Mg) wood burned	Wood Furnace <sup>a</sup> (AMS Code 21-04-008-010) lb/ton (mg/Mg) wood burned
<b>DIOXINS</b>			
2,3,7,8-TCDD	9.2x10 <sup>-9</sup> (4.6x10 <sup>-3</sup> )	2.8x10 <sup>-8</sup> (1.4x10 <sup>-2</sup> )	5.4x10 <sup>-9</sup> (2.7x10 <sup>-3</sup> )
Total Other TCDD	1.7x10 <sup>-7</sup> (8.6x10 <sup>-2</sup> )	NR	4.8x10 <sup>-7</sup> (2.4x10 <sup>-1</sup> )
Total PeCDD	9.8x10 <sup>-7</sup> (4.9x10 <sup>-1</sup> )	6.2x10 <sup>-7</sup> (3.1x10 <sup>-1</sup> )	8.8x10 <sup>-7</sup> (4.4x10 <sup>-1</sup> )
Total HxCDD	4.4x10 <sup>-7</sup> (2.2x10 <sup>-1</sup> )	4.8x10 <sup>-8</sup> (2.4x10 <sup>-2</sup> )	5.2x10 <sup>-7</sup> (2.6x10 <sup>-1</sup> )
Total HpCDD	3.4x10 <sup>-7</sup> (1.7x10 <sup>-1</sup> )	1.4x10 <sup>-8</sup> (7.0x10 <sup>-3</sup> )	7.2x10 <sup>-7</sup> (3.6x10 <sup>-1</sup> )
Total OCDD	3.0x10 <sup>-7</sup> (1.5x10 <sup>-1</sup> )	1.1x10 <sup>-8</sup> (5.6x10 <sup>-3</sup> )	9.0x10 <sup>-7</sup> (4.5x10 <sup>-1</sup> )
Total CDD	2.2x10 <sup>-6</sup> (1.1)	7.2x10 <sup>-7</sup> (3.6x10 <sup>-1</sup> )	3.5x10 <sup>-6</sup> (1.8)
<b>FURANS</b>			
2,3,7,8-TCDF	4.0x10 <sup>-7</sup> (2.0x10 <sup>-1</sup> )	NA	4.8x10 <sup>-7</sup> (2.4x10 <sup>-1</sup> )
Total Other TCDF	2.8x10 <sup>-6</sup> (1.4)	8.4x10 <sup>-9</sup> (4.2x10 <sup>-3</sup> )	6.8x10 <sup>-6</sup> (3.4)
Total PeCDF	3.4x10 <sup>-6</sup> (1.7)	4.0x10 <sup>-8</sup> (2.0x10 <sup>-2</sup> )	1.1x10 <sup>-5</sup> (5.5)
Total HxCDF	2.2x10 <sup>-6</sup> (1.1)	4.8x10 <sup>-7</sup> (2.4x10 <sup>-1</sup> )	3.2x10 <sup>-6</sup> (1.6)
Total HpCDF	5.0x10 <sup>-7</sup> (2.5x10 <sup>-1</sup> )	1.1x10 <sup>-8</sup> (5.6x10 <sup>-3</sup> )	5.8x10 <sup>-7</sup> (2.9x10 <sup>-1</sup> )
Total OCDF	2.8x10 <sup>-7</sup> (1.4x10 <sup>-1</sup> )	2.8x10 <sup>-9</sup> (1.4x10 <sup>-3</sup> )	1.2x10 <sup>-7</sup> (5.9x10 <sup>-2</sup> )
Total CDF	9.6x10 <sup>-6</sup> (4.8)	5.4x10 <sup>-7</sup> (2.7x10 <sup>-1</sup> )	2.2x10 <sup>-5</sup> (11.1)

Source: Reference 43.

<sup>a</sup> Based on particulate CDD/CDF concentrations and emission factors from AP-42 as follows:

Device	Emission Factor
wood stove	46.2 lb/ton (2.3x10 <sup>7</sup> mg/Mg)
fireplace	30.8 lb/ton (1.5x10 <sup>7</sup> mg/Mg)
wood furnace	46.2 lb/ton (2.3x10 <sup>7</sup> mg/Mg) (assumed to be identical to wood stove)

NA = Not available.

NR = Not reported.

gas CDD/CDF emissions data were obtained because of the large amounts of hydrocarbons present.<sup>46</sup>

Woodstove ash and flue wipe samples showed minimal CDD/CDF content. OCDD was the only homologue detected in the ash samples analyzed. The maximum OCDD content of the ash samples was 0.09 ppb. Small quantities of OCDD were found in each of the two flue wipe samples analyzed, with HpCDD also being detected in one of the two samples. The maximum OCDD content of the flue wipe samples was 0.6 parts per billion (ppb), and the measured HpCDD content was 0.04 ppb.<sup>46</sup>

CDD/CDF precursor analyses were performed on samples of the wood fed to the stove. The specific CDD/CDF precursors analyzed for were chlorophenols, chlorobenzenes, PCB, and total chlorides. Chlorobenzenes, chlorophenols, and PCB were not detected in the oak and pine samples analyzed. The total chloride contents of the oak and pine samples were 125 parts per million (ppm) and 49 ppm, respectively. In addition, continuous emissions monitoring was performed at the stove exhaust location for O<sub>2</sub>. The average O<sub>2</sub> content of the flue gas was 17.0 percent volume.<sup>46</sup>

Three additional studies provided information on CDD concentrations in the ash collected from 24 woodstoves. The woodstoves tested were located in rural areas in three different regions of the country. Presumably, the wood being burned was untreated, that is, it had not been exposed to fungicides, herbicides, or wood preservatives. No analysis was done for the PeCDD homologue. For the 24 woodstoves tested, CDD concentrations in ash samples ranged from 0.007-210 ppb, with a mean concentration of 23.4 ppb. Seventeen samples were analyzed for the 2,3,7,8-TCDD isomer. 2,3,7,8-TCDD was not detected in two samples. The detection limits of the samples ranged from 0.0009 to 0.0014 ppb. The other 15 samples had concentrations of 2,3,7,8-TCDD varying from 0.001 to 0.20 ppb, with an average concentration of 0.05 ppb. The authors of one of the studies, in which 18 woodstoves were tested, attributed some of the variability in the results to differences in woodstove design and sampling points.

They also suggested that some of the variability could potentially be attributed to fuel contamination, although feed samples were not analyzed for CDD content.<sup>9</sup>

In another study, ash samples from the chimneys of two fireplaces were analyzed for CDD. One fireplace was 12 years old and one was 25 years old. The latter had total CDD concentrations of 44.7 ppb, including 1 ppb of 2,3,7,8-TCDD. Ash samples from the 12-year-old fireplace contained 1.79 ppb CDD. No TCDD isomers were detected at a detection limit of 0.04 ppb. The PeCDD homologue was not analyzed for in either of these samples. Ash samples scraped from the flue pipe of a residential heater combusting wood found CDD levels of 0.97 ppb.<sup>9</sup>

#### Source Locations

Locations of residential combustion sources are tied directly to population trends.<sup>47</sup> Coal consumption for residential combustion purposes occurs mainly in the Northeast, Appalachian, and Midwest regions. Residential oil consumption is greatest in the Northeast and Mid-Atlantic regions. Wood-fired residential units are generally concentrated in heavily forested areas of the United States, which reflects fuel selection based on availability and price.<sup>14</sup>

#### 4.2.4 Waste Tire Incineration

Waste tires are incinerated for energy recovery and disposal purposes. Tires are combusted at tire-to-energy facilities, cement kilns, tire manufacturing facilities, and as supplemental fuel in boilers, especially in the pulp and paper industry. The U.S. EPA estimates that about 0.5 million metric tons (500 million kg) of tires are incinerated annually in the United States.<sup>48</sup> In 1990, 25.9 million (about 11 percent) of the 242 million tires discarded in the United States were converted to energy.<sup>48</sup> One report indicates that seven cement kilns utilized about 23 percent of the scrap tires in 1990, and that one tire-to-energy facility utilized about 19 percent.

The Scrap Tire Management Council reports that about 46 percent of discarded tires were utilized by eight different pulp and paper facilities.<sup>49</sup>

### Process Description

The combustion processes and procedures for burning discarded tires are the same as described previously within this section of this report.

### Emission Control Techniques

Available information from one tire-to-energy facility indicates the use of a spray dryer combined with a fabric filter for an air pollution control device.<sup>50</sup> These devices are capable of greater than 95 percent reduction and control of CDD/CDF compounds. However, operational and control device information for other tire incineration facilities in the United States is not known.

### Emission Factors

Emissions data and test reports from tire incineration facilities available at the time this report was prepared were limited. One test report available was from a study conducted at a tire-to-energy facility in California.<sup>50</sup> The facility consists of two excess air incinerators equipped with steam boilers for energy recovery. Whole tires were fed at a rate of 1364 lb/hr (3000 kg/hr). The facility uses a spray dryer and flue gas desulfurization followed by a fabric filter to control emissions.<sup>50</sup>

Emission factors for total CDD/CDF and TEQ in units of mg/kg of tires combusted were developed from emissions test results at this one facility.<sup>50</sup> From these data,

average CDD/CDF emission factors were estimated and are presented in Table 4-19. Extreme caution should be used in applying these emission factors to any other incinerator. If another facility was not equipped with the same devices, then the uncontrolled emissions of CDD/CDF could be much greater.

TABLE 4-19. CDD/CDF EMISSION FACTORS FROM WASTE TIRE INCINERATION

SCC 5-03-001-08  
FACTOR QUALITY RATING: E

Isomer	lb/ton tires burned	mg/kg tires burned
2,3,7,8-TCDD	$2.16 \times 10^{-11}$	$1.08 \times 10^{-8}$
2,3,7,8-TCDF	$5.42 \times 10^{-11}$	$2.71 \times 10^{-8}$
2,3,7,8-TCDD TEQ	$1.08 \times 10^{-9}$	$5.40 \times 10^{-7}$
Total CDD	$6.50 \times 10^{-9}$	$3.25 \times 10^{-6}$
Total CDF	$2.14 \times 10^{-8}$	$1.07 \times 10^{-5}$

Source: Reference 50.

### Source Locations

Because the burning of tires as waste occurs nationwide for various types of industries and combustors, no attempt was made to list specific sources or sites.

## 4.3 CREMATORIES

### 4.3.1 Process Description

Propane-fired Eclipse Burners (afterburner and ignition) are used at cemeteries for human body cremation. Eclipse Burners are rated at 2,115,000 Btu per hour capacity. Newer

units installed in the late 1980's are equipped with a modulating ignition burner. When afterburner temperatures reach about 1800°F (980°C), the ignition burner modulates to a low-fire mode that will reduce the Btu per hour usage.

When the crematory reaches an operating temperature of 1,250°F (680°C) the body container is placed on the combustion chamber grate and the ignition burner is fired to attain a target combustion temperature sufficient for the proper reduction of human remains. The chamber preheat by the afterburner reaches 1,250°F (680°C) in about 30 to 45 minutes prior to ash removal. When the body container is introduced into the combustion chamber, and the burner is ignited, cremation begins at about 1600 to 1800°F (870 to 980°C). Flame impingement on the body takes two to three minutes; cremation occurs for about two hours. The remains are then raked towards the ignition burner for about two minutes. Cooldown follows for 45 minutes to 1.5 hours. During normal operation, three bodies per day are cremated in each retort.

#### 4.3.2 Emission Factors

Evaluation tests on two propane fired crematories at a cemetery in California were conducted through a cooperative effort with the Sacramento Metropolitan Air Quality Management District to determine emissions of toxic substances from a crematory.<sup>51</sup> The units were calibrated to operate at a maximum of 1,450,000 Btu/hour. Emissions testing was performed over a two week period; thirty-six bodies were cremated during the test period. This equates to two bodies per crematory per day for nine days. The body and cardboard weights and wood process rates for each test per crematory were reported.

CDD/CDF sampling, recovery, and analysis were performed in accordance with California Air Resources Board (CARB) Method 428, which is based on the use of EPA Reference Modified Method 5 sampling train. Data from stack gas measurements from each of the nine tests performed during the evaluation program were tabulated and reported. Emission factors developed from these data are presented in Table 4-20.

TABLE 4-20. CDD/CDF EMISSION FACTORS FROM A CREMATORY

Isomer	Average Emission Factor in lb/body incinerated (kg/body incinerated)	Range of Data lb/body incinerated (kg/body incinerated)
2,3,7,8-TCDD	$4.58 \times 10^{-14}$ ( $2.08 \times 10^{-14}$ )	$1.69 \times 10^{-14}$ - $9.54 \times 10^{-14}$ ( $7.67 \times 10^{-15}$ - $4.33 \times 10^{-14}$ )
Total TCDD	$8.86 \times 10^{-13}$ ( $4.03 \times 10^{-13}$ )	$1.76 \times 10^{-13}$ - $1.91 \times 10^{-12}$ ( $7.67 \times 10^{-15}$ - $4.33 \times 10^{-14}$ )
1,2,3,7,8-PeCDD	$1.44 \times 10^{-13}$ ( $6.53 \times 10^{-14}$ )	$3.60 \times 10^{-14}$ - $2.79 \times 10^{-13}$ ( $1.63 \times 10^{-14}$ - $1.27 \times 10^{-13}$ )
Total PeCDD	$1.37 \times 10^{-12}$ ( $6.21 \times 10^{-13}$ )	$4.33 \times 10^{-13}$ - $3.23 \times 10^{-12}$ ( $1.96 \times 10^{-13}$ - $1.47 \times 10^{-12}$ )
1,2,3,4,7,8-HxCDD	$1.73 \times 10^{-13}$ ( $7.85 \times 10^{-14}$ )	$4.85 \times 10^{-14}$ - $3.96 \times 10^{-13}$ ( $2.20 \times 10^{-14}$ - $1.80 \times 10^{-13}$ )
1,2,3,6,7,8-HxCDD	$2.50 \times 10^{-13}$ ( $1.13 \times 10^{-13}$ )	$5.21 \times 10^{-14}$ - $6.02 \times 10^{-13}$ ( $2.36 \times 10^{-14}$ - $2.73 \times 10^{-13}$ )
1,2,3,7,8,9-HxCDD	$3.12 \times 10^{-13}$ ( $1.42 \times 10^{-13}$ )	$3.96 \times 10^{-14}$ - $8.08 \times 10^{-13}$ ( $1.80 \times 10^{-14}$ - $3.67 \times 10^{-13}$ )
Total HxCDD	$3.55 \times 10^{-12}$ ( $1.61 \times 10^{-12}$ )	$9.54 \times 10^{-13}$ - $8.08 \times 10^{-12}$ ( $4.33 \times 10^{-13}$ - $3.67 \times 10^{-12}$ )
1,2,3,4,6,7,8-HpCDD	$2.37 \times 10^{-12}$ ( $1.08 \times 10^{-12}$ )	$3.60 \times 10^{-13}$ - $5.29 \times 10^{-12}$ ( $1.63 \times 10^{-13}$ - $2.40 \times 10^{-12}$ )
Total HpCDD	$5.09 \times 10^{-12}$ ( $2.31 \times 10^{-12}$ )	$8.08 \times 10^{-12}$ - $1.10 \times 10^{-11}$ ( $3.67 \times 10^{-12}$ - $4.99 \times 10^{-12}$ )
Total OCDD	$3.77 \times 10^{-12}$ ( $1.71 \times 10^{-12}$ )	$6.53 \times 10^{-13}$ - $6.46 \times 10^{-12}$ ( $3.02 \times 10^{-13}$ - $2.93 \times 10^{-12}$ )
Total CDD	$1.47 \times 10^{-11}$ ( $6.67 \times 10^{-12}$ )	$3.02 \times 10^{-12}$ - $3.07 \times 10^{-11}$ ( $1.37 \times 10^{-12}$ - $1.39 \times 10^{-11}$ )
2,3,7,8-TCDF	$3.31 \times 10^{-13}$ ( $1.50 \times 10^{-13}$ )	$9.03 \times 10^{-14}$ - $5.07 \times 10^{-13}$ ( $4.10 \times 10^{-14}$ - $2.30 \times 10^{-13}$ )
Total TCDF	$6.90 \times 10^{-12}$ ( $3.13 \times 10^{-12}$ )	$2.28 \times 10^{-12}$ - $1.62 \times 10^{-11}$ ( $1.03 \times 10^{-12}$ - $7.35 \times 10^{-12}$ )
1,2,3,7,8-PeCDF	$< 2.01 \times 10^{-13}$ ( $< 9.12 \times 10^{-14}$ )	$8.81 \times 10^{-14}$ - $4.26 \times 10^{-13}$ ( $3.40 \times 10^{-14}$ - $1.93 \times 10^{-13}$ )
2,3,4,7,8-PeCDF	$< 5.76 \times 10^{-13}$ ( $< 2.61 \times 10^{-13}$ )	$1.10 \times 10^{-13}$ - $1.10 \times 10^{-12}$ ( $4.99 \times 10^{-14}$ - $4.99 \times 10^{-13}$ )

TABLE 4-20. CDD/CDF EMISSION FACTORS FROM A CREMATORY (CONTINUED)

Isomer	Average Emission Factor in lb/body incinerated (kg/body incinerated)	Range of Data lb/body incinerated (kg/body incinerated)
Total PeCDF	$4.06 \times 10^{-12}$ ( $1.84 \times 10^{-12}$ )	$2.13 \times 10^{-13}$ - $1.03 \times 10^{-11}$ ( $9.66 \times 10^{-14}$ - $4.67 \times 10^{-12}$ )
1,2,3,4,7,8-HxCDF	$5.97 \times 10^{-13}$ ( $2.71 \times 10^{-13}$ )	$2.06 \times 10^{-13}$ - $1.25 \times 10^{-12}$ ( $9.34 \times 10^{-14}$ - $5.67 \times 10^{-13}$ )
1,2,3,6,7,8-HxCDF	$5.38 \times 10^{-13}$ ( $2.44 \times 10^{-13}$ )	$1.76 \times 10^{-13}$ - $1.25 \times 10^{-12}$ ( $7.98 \times 10^{-14}$ - $5.67 \times 10^{-13}$ )
1,2,3,7,8,9-HxCDF	$1.05 \times 10^{-12}$ ( $4.76 \times 10^{-13}$ )	$3.82 \times 10^{-13}$ - $2.35 \times 10^{-12}$ ( $1.73 \times 10^{-13}$ - $1.07 \times 10^{-12}$ )
2,3,4,6,7,8-HxCDF	$2.16 \times 10^{-13}$ ( $9.80 \times 10^{-14}$ )	$8.08 \times 10^{-14}$ - $4.70 \times 10^{-13}$ ( $3.67 \times 10^{-14}$ - $2.13 \times 10^{-13}$ )
Total HxCDF	$6.85 \times 10^{-12}$ ( $3.11 \times 10^{-12}$ )	$2.20 \times 10^{-12}$ - $1.62 \times 10^{-11}$ ( $9.98 \times 10^{-13}$ - $7.35 \times 10^{-12}$ )
1,2,3,4,6,7,8-HpCDF	$< 3.08 \times 10^{-12}$ ( $< 1.40 \times 10^{-12}$ )	$7.34 \times 10^{-13}$ - $7.27 \times 10^{-12}$ ( $3.33 \times 10^{-13}$ - $3.30 \times 10^{-12}$ )
1,2,3,4,7,8,9-HpCDF	$< 1.89 \times 10^{-13}$ ( $< 8.57 \times 10^{-14}$ )	$3.30 \times 10^{-14}$ - $4.92 \times 10^{-13}$ ( $1.50 \times 10^{-14}$ - $2.23 \times 10^{-13}$ )
Total HpCDF	$< 3.62 \times 10^{-12}$ ( $< 1.64 \times 10^{-12}$ )	$8.08 \times 10^{-13}$ - $8.81 \times 10^{-12}$ ( $3.67 \times 10^{-13}$ - $4.00 \times 10^{-12}$ )
Total OCDF	$1.01 \times 10^{-12}$ ( $4.58 \times 10^{-13}$ )	$3.82 \times 10^{-13}$ - $1.69 \times 10^{-12}$ ( $1.73 \times 10^{-13}$ - $7.67 \times 10^{-13}$ )
Total CDF	$< 2.24 \times 10^{-11}$ ( $< 1.02 \times 10^{-11}$ )	$6.89 \times 10^{-12}$ - $5.31 \times 10^{-11}$ ( $3.13 \times 10^{-12}$ - $2.41 \times 10^{-11}$ )

Source: Reference 51.

<sup>a</sup> Sampled at the stack.

<sup>b</sup> Both units equipped with afterburners.



### 4.3.3 Source Location

In 1991, there were about 400,500 cremations in more than 1,000 crematories located throughout the United States. Table 4-21 lists the number of crematories located in each state and the estimated number of cremations performed in each state for the year 1990, where itemized data were available.<sup>52</sup>

## 4.4 IRON AND STEEL FOUNDRIES/SCRAP METAL MELTING

### 4.4.1 Process Description

Iron and steel foundries can be defined as those that produce gray, white, ductile, or malleable iron and steel castings. Both cast irons and steels are solid solutions of iron, carbon, and various alloying materials. Iron foundries produce iron castings from scrap iron, pig iron, and foundry returns by melting, alloying, and molding. The major operations include: (1) raw material handling and preparation, (2) metal melting, (3) mold and core production, and (4) casting and finishing. A generic flow diagram for iron and steel foundries is shown in Figure 4-15. Figure 4-16 depicts the emission points in a typical iron foundry.

Iron and steel castings are produced in a foundry by injecting or pouring molten metal into cavities of a mold made of sand, metal, or ceramic material. The metal melting process is accomplished primarily in cupola (or blast) furnaces, and to a lesser extent in electric arc furnaces (EAF). The cupola, which is the major type of furnace used in industry today, is typically a vertical, cylindrical steel shell with either a refractory lined or water cooled inner wall. Refractory linings usually consist of silica brick, or dolomite or magnesium brick. Cupolas are charged with alternate layers of coke, metallics, and fluxes. Combustion air is introduced into the cupola through tuyeres located at the base. About 70 percent of all iron castings are produced using cupolas, while steel foundries rely almost exclusively on EAFs or induction furnaces for melting purposes.

TABLE 4-21. 1991 U.S. CREMATORY LOCATIONS BY STATE

State	No. of Crematories	No. of Cremations <sup>a</sup>	State	No. of Crematories	No. of Cremations <sup>a</sup>
Alabama	6	1,138	Montana	12	2,502
Alaska	7	790	Nebraska	6	1,139
Arizona	26	10,189	Nevada	11	5,009
Arkansas	13	1,787	New Hampshire	6	1,842
California	141	86,374	New Jersey	16	14,427
Colorado	28	7,432	New Mexico	9	2,134
Connecticut	10	4,260	New York	40	23,946
Delaware	4	1,165	North Carolina	24	4,749
District of Columbia	1	b	North Dakota	1	b
Florida	95	46,775	Ohio	41	12,552
Georgia	14	2,684	Oklahoma	9	1,372
Hawaii	10	3,495	Oregon	34	9,020
Idaho	12	1,949	Pennsylvania	44	12,153
Illinois	44	12,083	Rhode Island	5	1,842
Indiana	21	3,636	South Carolina	10	1,764
Iowa	15	2,241	South Dakota	4	b
Kansas	10	1,559	Tennessee	8	1,712
Kentucky	5	1,192	Texas	36	9,340
Louisiana	6	1,853	Utah	5	769
Maine	4	2,656	Vermont	5	1,570
Maryland	17	5,587	Virginia	25	6,097
Massachusetts	13	8,104	Washington	46	15,673
Michigan	38	13,431	West Virginia	6	582
Minnesota	18	5,662	Wisconsin	29	5,541
Mississippi	4	450	Wyoming	2	b
Missouri	19	4,637			

Source: Reference 52.

<sup>a</sup> 1990 data. Data allocated by state for 1991 were not available.

<sup>b</sup> No information available.

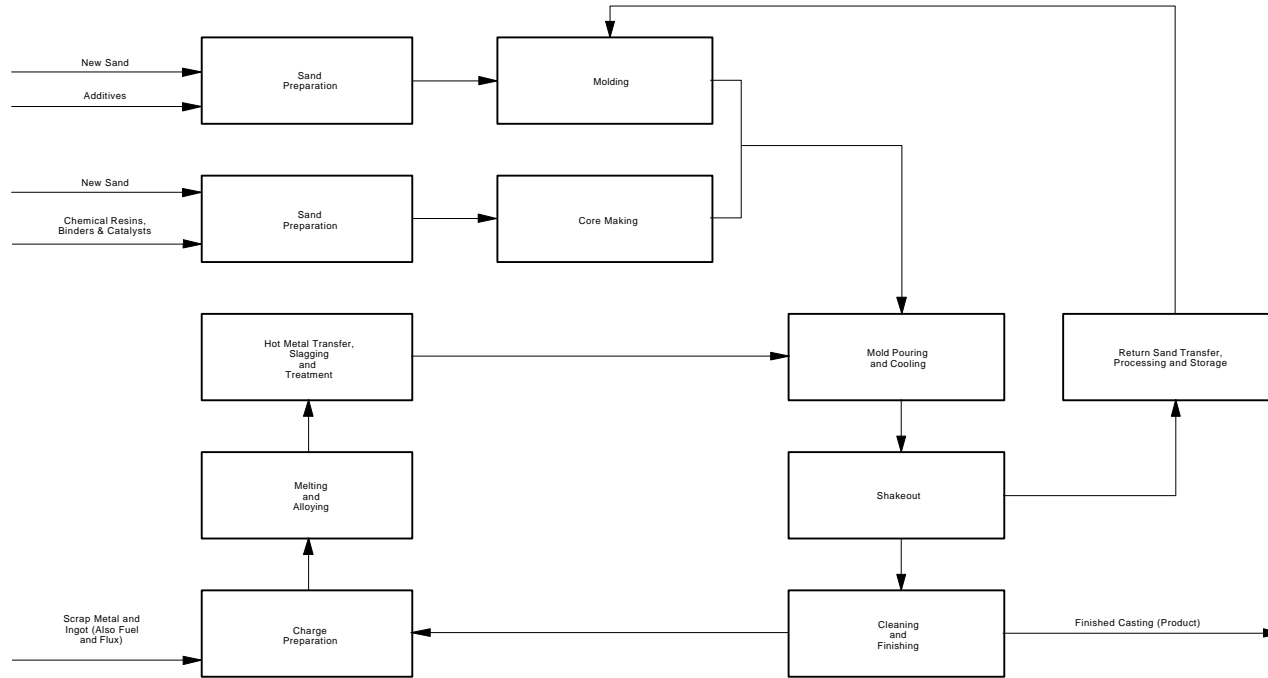

Figure 4-15. Process Flow Diagram for a Typical Sand-cast Iron and Steel Foundry

Source: Reference 53.

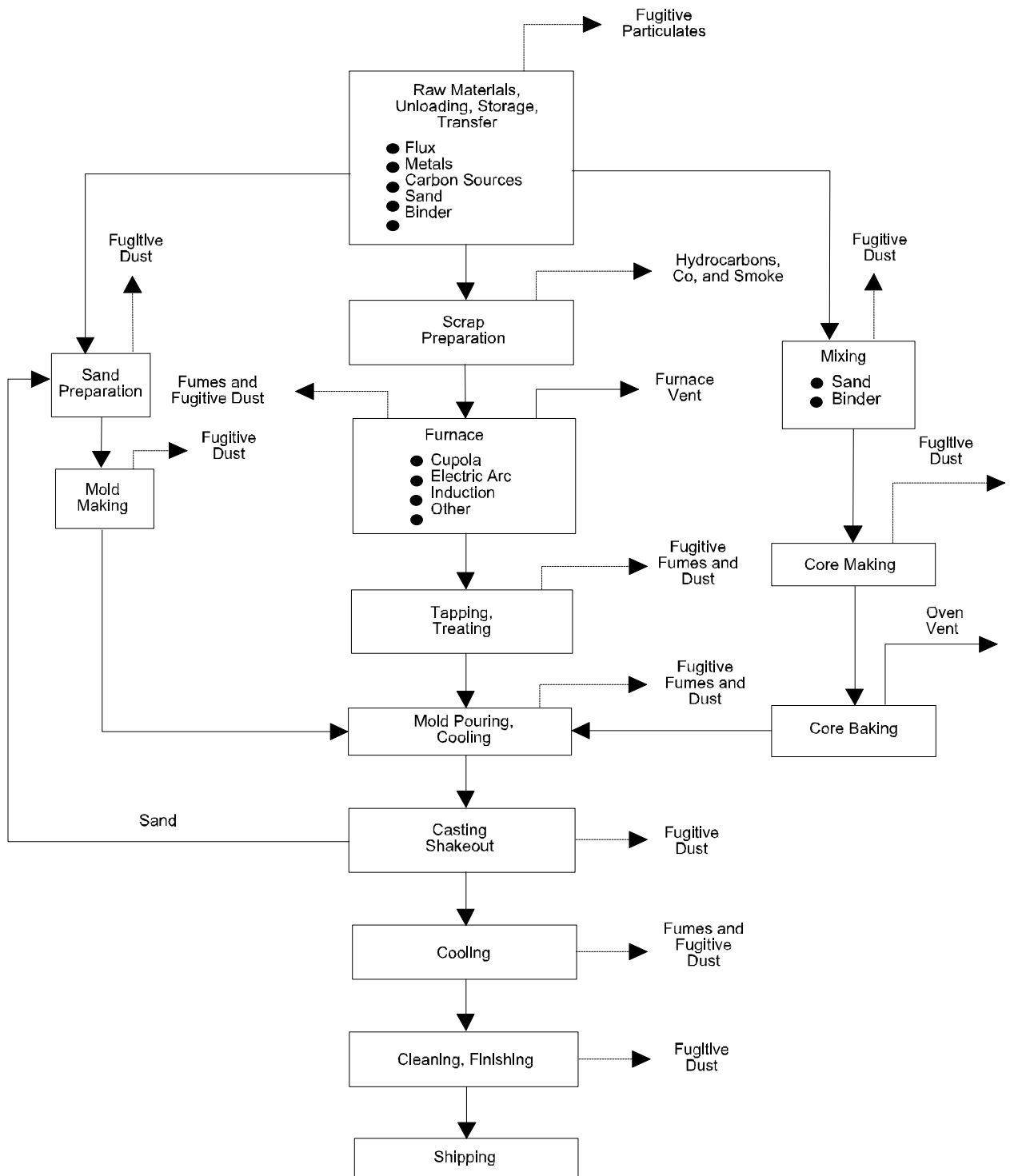

Figure 4-16. Emission Points in a Typical Iron and Steel Foundry

Source: Reference 53.

The heat produced by the burning coke melts the iron, which flows down and is tapped from the bottom of the cupola. Fluxes combine with non-metallic impurities in the charge and form slag, which is removed through tap holes at the bottom of the cupola. Cupola capacities range from 1 to 30 tons (1 to 27 Mg) per hour, with a few large units capable of producing close to 100 tons (90 Mg) per hour. Larger furnaces are operated continuously, with periodic inspections and cleanings between burn cycles.<sup>53</sup>

In either type of foundry, when the poured metal has solidified, the molds are separated and the castings removed from the mold flasks on a casting shakeout unit. Abrasive (shotblasting) cleaning, grinding, and heat treating are performed as necessary. The castings are then inspected and shipped to another industry for machining and/or assembly into a final product.<sup>54</sup>

#### 4.4.2 Emission Control Techniques

Emissions from cupolas can vary widely, depending on blast rate, blast temperature, melt rate, coke-to-melt ratio and control technologies. Control technologies commonly used to control emissions from iron and steel foundry metal melting operations include baghouses, wet scrubbers, and afterburners. Additionally, emissions due to coke combustion may be reduced by substitution of gas for heat or the use of graphite as a carbon source.<sup>53</sup>

Scrap preparation with heat will emit smoke, organic compounds, and carbon monoxide, and scrap preparation with solvent degreasers will emit organics. Catalytic incinerators and afterburners can control about 95 percent of organic and carbon monoxide emissions. Emissions released from the melting furnaces include particulate matter, carbon monoxide, organic compounds, sulfur dioxide, nitrogen oxides, and small quantities of chloride and fluoride compounds.

#### 4.4.3 Emission Factors

Scrap metal melting processes have been found to be one source of CDD/CDF. The use of chlorinated compounds in iron and steel processes and the use of recycled scrap metal contaminated with cutting oils and plastics containing chlorine provide all conditions required for the formation of chlorinated aromatic compounds.

A study funded by the Swedish Steel Producers Association noted that the amount of chlorine loaded (into a furnace) is of importance, but the design of the charging process seems to be the determining factor for the formation of CDD/CDF. The Swedish study was carried out in a pilot plant with a 10-ton electric furnace charging scrap metal under different operational conditions, either continuously through the furnace or batchwise into the open furnace. CDD/CDF were detected in the range of 0.1 to 1.5 ng TCDD-equivalents per normal cubic meter (Nm<sup>3</sup>) dry gas. The largest emissions were observed during charging of scrap metal containing PVC plastics.<sup>53</sup>

The emission factors presented in Table 4-22 were developed from a facility test reporgenerated to comply with the requirements of California Assembly Bill (AB2588).<sup>55</sup> The test program quantified emissions from a batch-operated cupola furnace charged with pig iron, scrap iron, steel scrap, coke, and limestone. Emission control devices operating during the tests were an oil-fired afterburner and a baghouse.

Coke combined with combustion air provided the heat necessary to melt the metal, which was continuously tapped from the cupola, converted to ductile iron, and poured into steel pipe molds. Combustion gases from the cupola were vented to a gas-/oil-fired afterburner followed by a baghouse.

TABLE 4-22. CDD/CDF EMISSION FACTORS FROM A CUPOLA FURNACE<sup>a</sup>  
 SCC 3-04-003-01

FACTOR QUALITY RATING: D

Isomer	Average Emission Factor	
	lb/ton	kg/Mg <sup>b</sup>
2,3,7,8-TCDD	6.61x10 <sup>-11</sup>	3.31x10 <sup>-11</sup>
Total TCDD	7.92x10 <sup>-9</sup>	3.96x10 <sup>-9</sup>
1,2,3,7,8-PeCDD	1.71x10 <sup>-10</sup>	8.55x10 <sup>-11</sup>
Total PeCDD	3.52x10 <sup>-9</sup>	1.76x10 <sup>-9</sup>
1,2,3,6,7,8-HxCDD	1.01x10 <sup>-10</sup>	5.05x10 <sup>-11</sup>
Total HxCDD	1.10x10 <sup>-9</sup>	5.50x10 <sup>-10</sup>
1,2,3,4,6,7,8-HpCDD	1.85x10 <sup>-10</sup>	9.25x10 <sup>-11</sup>
Total HpCDD	3.81x10 <sup>-10</sup>	1.91x10 <sup>-10</sup>
Total OCDD	NR	NR
Total CDD	1.34x10 <sup>-8</sup>	6.72x10 <sup>-9</sup>
2,3,7,8-TCDF	1.04x10 <sup>-9</sup>	5.20x10 <sup>-10</sup>
Total TCDF	5.16x10 <sup>-8</sup>	2.58x10 <sup>-8</sup>
1,2,3,7,8-PeCDF	6.10x10 <sup>-10</sup>	3.05x10 <sup>-10</sup>
2,3,4,7,8-PeCDF	6.99x10 <sup>-10</sup>	3.50x10 <sup>-10</sup>
Total PeCDF	1.70x10 <sup>-8</sup>	8.50x10 <sup>-7</sup>
1,2,3,4,7,8-HxCDF	3.79x10 <sup>-10</sup>	1.90x10 <sup>-10</sup>
1,2,3,6,7,8-HxCDF	3.39x10 <sup>-10</sup>	1.70x10 <sup>-10</sup>
2,3,4,6,7,8-HxCDF	2.02x10 <sup>-10</sup>	1.01x10 <sup>-10</sup>
Total HxCDF	3.47x10 <sup>-9</sup>	1.74x10 <sup>-9</sup>
1,2,3,4,6,7,8-HpCDF	3.85x10 <sup>-10</sup>	1.93x10 <sup>-10</sup>
Total HpCDF	4.87x10 <sup>-10</sup>	2.44x10 <sup>-10</sup>
Total OCDF	1.17x10 <sup>-10</sup>	5.85x10 <sup>-11</sup>
Total CDF	7.63x10 <sup>-8</sup>	8.8x10 <sup>-7</sup>

Source: Reference 55.

<sup>a</sup> Control device: Afterburner/baghouse.

<sup>b</sup> Emission factors are lb (kg) of pollutant per ton (Mg) of metal charged.

#### 4.4.4 Source Location

Based on a survey conducted by the EPA in support of the iron and steel foundry maximum achievable control technology (MACT) standard development, there were 756 iron and steel foundries in the United States in 1992.<sup>56</sup> Foundry locations can be correlated with areas of heavy industry and manufacturing and, in general, with the iron and steel production industry (Ohio, Pennsylvania, and Indiana).

Additional information on iron and steel foundries and their locations may be obtained from the following trade associations:

- American Foundrymen's Society, Des Plaines, Illinois;
- National Foundry Association, Des Plaines, Illinois;
- Ductile Iron Society, Mountainside, New Jersey;
- Iron Casting Society, Warrendale, Pennsylvania; and
- Steel Founders' Society of America, Des Plaines, Illinois.

#### 4.5 COMBUSTION-AIDED METAL RECOVERY

This section discusses CDD/CDF emissions from secondary metals recovery facilities that use combustion to eliminate combustible materials present in scrap raw material. During combustion, various solids (e.g., plastics) and liquids (e.g., solvents or oils) are burned off in initial processing steps, leaving the metals free of combustible contaminants and suitable for further processing. The combustion of chlorine-containing plastics or liquids in these processes can produce CDD/CDF emissions.

This section describes the processes used for five types of secondary metal recovery: (1) secondary copper smelters, (2) secondary aluminum production, (3) secondary lead



production, (4) scrap metal reclamation furnaces, and (5) drum and barrel reclamation furnaces. CDD/CDF emission factors are given for each process. Each emission factor presented for these sources represents a unique furnace. A factor for one furnace should not be applied to another similar furnace without considering differences in feedstock and combustion conditions.

In addition to the five listed above, secondary ferrous metals recovery processes could produce CDD/CDF emissions. However, CDD/CDF emissions test data are not currently available for those processes.

#### 4.5.1 Secondary Copper Smelters

Secondary copper smelters recover copper from copper-bearing scrap materials, including electronic materials scrap, brass, iron-bearing copper scrap, and other copper-bearing materials. Some of the scrap materials contain chlorinated plastics such as polyvinyl chloride (PVC). CDD/CDF are produced as the plastic and other combustible materials are combusted in the blast furnace. Figure 4-17 presents a general process flow diagram of a secondary copper smelter.

##### Process Description

The feed material used in secondary copper recovery can be pretreated using several different procedures, either separately or in combination. Feed scrap is concentrated by manual or mechanical methods such as sorting, stripping, shredding, and magnetic separation. Feed scrap is sometimes formed into briquettes in a hydraulic press. Pyrometallurgical pretreatment may include sweating, burning of insulation (especially from wire scrap), and drying (burning off oil and volatiles) in rotary kilns. These techniques may cause the formation of CDD/CDF. Hydrometallurgical methods include flotation and leaching with chemical recovery.

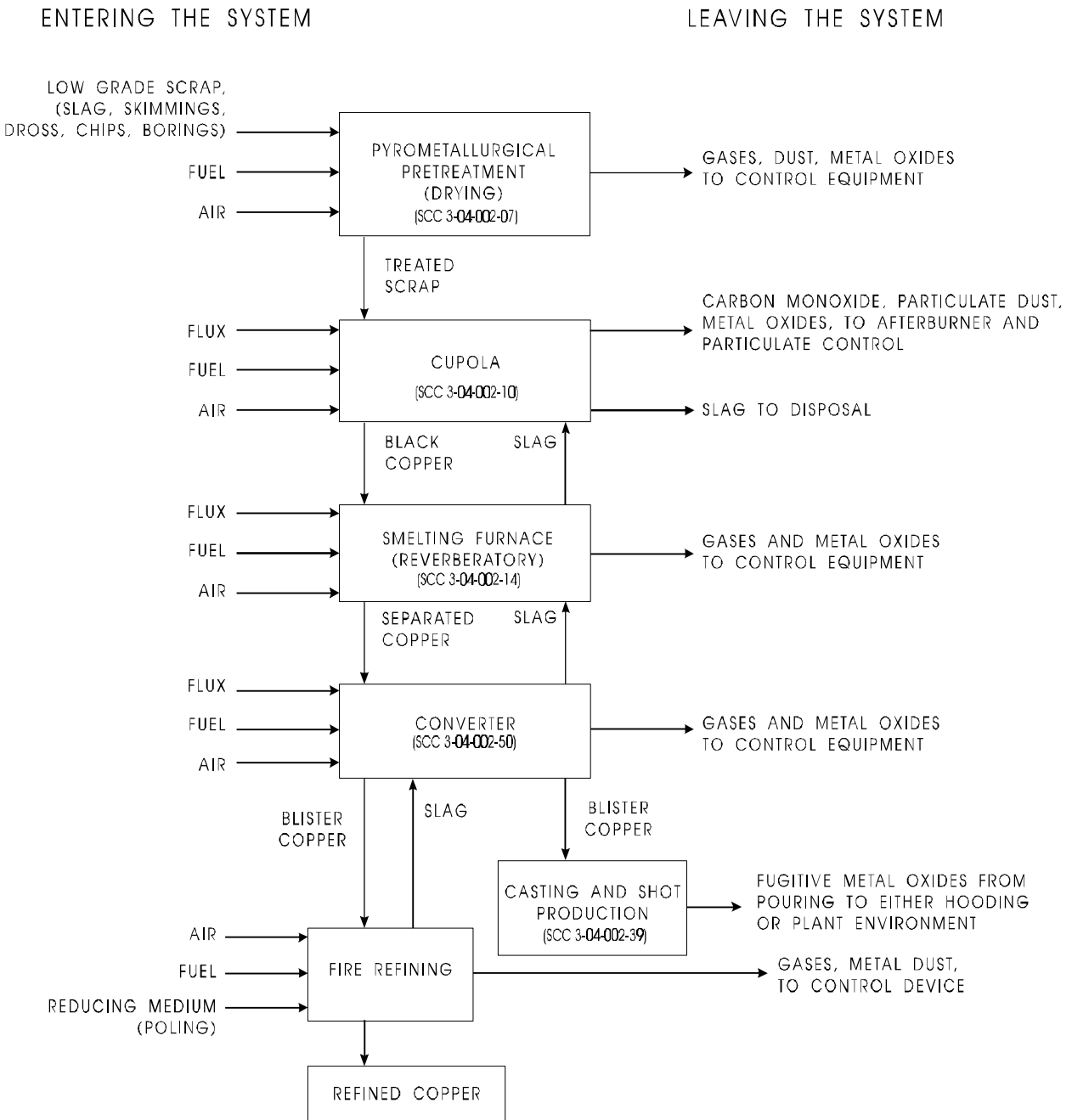

Figure 4-17. Secondary Copper Recovery Process Flow Diagram

Source: Reference 57.

Pretreated scrap that contains 10 to 30 percent copper is normally smelted in a cupola-type blast furnace. A cupola furnace is a vertical, refractory-lined cylinder open at the top and equipped with vents at the bottom. Alternative charges of scrap, coke, and limestone are placed on top of a burning bed of coke. As the scrap is heated, the metal melts and is drawn off through a tap hole and spout at the bottom of the furnace; the combustibles are burned off and combustion gases and PM exit the furnace. Oxides of copper and heavy metals are chemically reduced. Various impurities, such as iron, combine to form a slag, which collects on top of the molten metal and can be drawn off separately.

In a typical system, further smelting and refining are accomplished using a reverberatory holding furnace, a converter, and a reverberatory or rotary refining furnace. The holding furnace retains the melt until a sufficient batch is accumulated to form a charge to the converter, and allows for tapping the slag. (An electric arc furnace can also be used for this purpose.) Feed with a low-copper value can also be smelted in electric crucible or pot furnaces, where pure oxygen is used in place of air for oxidation.

A converter consists of a cylindrical steel shell that can be rotated about its longitudinal axis. An opening in one side emits the molten charge and vents gases. Air is blown through the melt by means of a horizontal row of pipes with openings (tuyeres) that are below the liquid metal when the furnace is rotated. A silica flux is added to remove iron from the metal, whereas zinc and any sulfur are converted to their respective oxides by the air that is blown in.

The product from the converter is blister copper, usually 90 to 99 percent pure. This material may be poured and cast into ingots or it may be transferred while molten to another furnace for a final pyrometallurgical process known as fire refining.

Blister copper is typically purified further by fire refining to about 99.9 percent copper. Fire-refined copper is cast into wirebar as well as ingots. The refining processes are essentially the same in secondary smelting as in primary copper smelting. Fire-refining furnaces

are typically reverberatory or rotary furnaces. In both furnaces, air is blown through the molten metal to oxidize impurities that are removed as oxides in the slag, which is skimmed or poured off. Copper oxide, formed to the extent of less than 1 percent of copper, is reduced by "poling" (submerging wooden poles in the molten metal) or by supplying a reducing atmosphere of gas (by fuel-rich combustion). The usual sequence of events in fire refining is (1) charging, (2) melting, (3) skimming, (4) blowing, (5) adding fluxes, (6) reducing, (7) reskimming, and (8) pouring.

Electrolytic refining may be done as an additional step to produce electrolytic copper. Electrolytic refining separates impurities from the copper by electrolysis in a solution containing both copper sulfate and sulfuric acid. Metallic impurities form a sludge that can be removed and treated for recovery of precious metals.

#### Emission Control Techniques

Generally, afterburners (usually natural gas-fired) are located at the top of the cupola furnace and serve to complete the combustion of the exhaust gases. These afterburners control emissions of unburned combustible PM and organic compounds.

Exhaust gases from the furnace after the afterburners are typically cooled with water in a spray chamber and mixed with ventilation gases from the furnace charge floor and/or ambient air. Generally, this gas stream is then passed through a fabric filter (baghouse) before release to the atmosphere.

#### Emission Factors

Emission factors were identified for a secondary copper recovery cupola furnace firing scrap materials that included shredded telephone equipment, other copper-bearing metallic scrap, metallurgical slags, and plant revert, along with coke and limestone.<sup>58</sup> The shredded telephone equipment was composed of circuit boards, switching gear, telephone parts, and other

miscellaneous plastic parts. Some of the plastic contained in the scrap was PVC. The total amount of telephone scrap processed accounted for 22 percent by weight of the total scrap feed. No other scrap materials contained plastic materials.

The facility was equipped with natural gas-fired afterburners and a fabric filter. Flue gas temperature after the afterburners averaged 1,610°F (877°C). After water spray cooling, flue gas temperatures at the inlet to the fabric filter averaged 320°F (146°C).

Emissions of TCDD/TCDF through OCDD/OCDF were measured after the fabric filter at the stack outlet. Table 4-23 presents CDD/CDF emissions on a flue gas-concentration basis and as emission factors. Emission factors are based on the total weight of scrap metal (plastic and nonplastic-bearing metal) fed to the furnace.

#### 4.5.2 Secondary Aluminum Production

Secondary aluminum producers recycle aluminum from aluminum-containing scrap, while primary aluminum producers convert bauxite ore into aluminum. The secondary aluminum industry was responsible for 27.5 percent of domestic aluminum produced in 1989. There are approximately 116 plants with a recovery capacity of approximately 2.6 million tons (2.4 million megagrams) of aluminum per year. Actual total secondary aluminum production was relatively constant during the 1980s. However, increased demand for aluminum by the automobile industry has doubled in the last 10 years to an average of 173 pounds (78.5 kilograms) per car. Recycling of used aluminum beverage cans (UBC) increased more than 26 percent from 1986 to 1989. In 1989, 1.4 million tons (1.3 million megagrams) of UBCs were recycled, representing over 60 percent of cans shipped. Recycling a ton of aluminum requires only 5 percent of the energy required to refine a ton of primary aluminum from bauxite ore, making the secondary aluminum economically viable.

TABLE 4-23. CDD/CDF EMISSION CONCENTRATIONS AND EMISSION FACTORS FOR  
SECONDARY COPPER SMELTING -  
COPPER RECOVERY CUPOLA FURNACE

SCC 3-04-002-11  
FACTOR QUALITY RATING: D

Isomer	Flue Gas Concentration in lb/ft <sup>3</sup> ( $\mu\text{g}/\text{dscm}$ at 3% O <sub>2</sub> )	Emission Factor in lb/ton ( $\mu\text{g}/\text{kg}$ scrap feed) <sup>a,b,c</sup>
<b>DIOXINS</b>		
2,3,7,8-TCDD	1.45x10 <sup>-8</sup> (232)	2.54x10 <sup>-7</sup> (0.127)
Total Other TCDD	7.12x10 <sup>-8</sup> (1,140)	1.22x10 <sup>-6</sup> (0.609)
Total PeCDD	1.13x10 <sup>-7</sup> (1,810)	1.94x10 <sup>-6</sup> (0.970)
Total HxCDD	1.45x10 <sup>-7</sup> (2,320)	2.52x10 <sup>-6</sup> (1.26)
Total HpCDD	2.43x10 <sup>-7</sup> (3,890)	4.16x10 <sup>-6</sup> (2.08)
Total OCDD	1.57x10 <sup>-7</sup> (2,520)	2.70x10 <sup>-6</sup> (1.35)
Total CDD	7.43x10 <sup>-7</sup> (11,900)	1.28x10 <sup>-5</sup> (6.39)
<b>FURANS</b>		
2,3,7,8-TCDF	3.17x10 <sup>-7</sup> (5,070)	5.44x10 <sup>-6</sup> (2.72)
Total Other TCDF	1.29x10 <sup>-6</sup> (20,600)	2.20x10 <sup>-5</sup> (11.0)
Total PeCDF	1.00x10 <sup>-6</sup> (16,100)	1.73x10 <sup>-5</sup> (8.64)
Total HxCDF	4.86x10 <sup>-7</sup> (7,790)	8.48x10 <sup>-6</sup> (4.24)
Total HpCDF	3.98x10 <sup>-7</sup> (6,380)	6.84x10 <sup>-6</sup> (3.42)
Total OCDF	2.93x10 <sup>-7</sup> (4,700)	5.04x10 <sup>-6</sup> (2.52)
Total CDF	3.79x10 <sup>-6</sup> (60,700)	6.50x10 <sup>-5</sup> (32.5)
<b>TOTAL CDD/CDF</b>	<b>4.53x10<sup>-6</sup> (72,600)</b>	<b>7.78x10<sup>-5</sup> (38.89)</b>

Source: Reference 58.

<sup>a</sup> Emissions measured in the stack gases after an afterburner and a fabric filter.

<sup>b</sup> Includes all scrap feed (plastic and nonplastic-bearing) including coke and limestone.

<sup>c</sup> The feed scrap for this furnace contained 22 percent by weight plastic-containing scrap.

## Process Description

Secondary aluminum production involves two general categories of operations-- scrap pretreatment and smelting/refining. Pretreatment operations include sorting, processing, and cleaning scrap. Smelting/refining operations include cleaning, melting, refining, alloying, and pouring of aluminum recovered from scrap. The processes used to convert scrap aluminum to products such as lightweight aluminum alloys for industrial castings are in involved at any one facility. Some steps may be combined or reordered, depending on the type of scrap used (see Figures 4-18a and 4-18b). Some or all the steps in these figures may be quality, source of scrap, auxiliary equipment available, furnace design, and product specifications. Plant configuration, scrap type usage, and product output varies throughout the secondary aluminum industry.

Scrap Pretreatment--Aluminum scrap comes from a variety of sources. "New" scrap is generated by pre-consumer sources, such as drilling and machining of aluminum castings, scrap from aluminum fabrication and manufacturing operations, and aluminum bearing residual material (dross) skimmed off molten aluminum during smelting operations. "Old" aluminum scrap is material that has been used by the consumer and discarded. Examples of old scrap include used appliances, aluminum foil, automobile and airplane parts, aluminum siding, and beverage cans.<sup>59</sup>

Scrap pretreatment involves sorting and processing scrap to remove contaminants and to prepare the material for smelting. Sorting and processing separates the aluminum from other metals, dirt, oil, plastics, and paint. Pretreatment cleaning processes are based on mechanical, pyrometallurgical, and hydrometallurgical techniques.

*Mechanical Cleaning:* Mechanical cleaning includes the physical separation of aluminum from other scrap, with hammer mills, ring rushers, and other machines to break scrap containing aluminum into smaller pieces. This improves the efficiency of downstream recovery by magnetic removal of iron. Other recovery processes include vibratory screens and air classifiers.

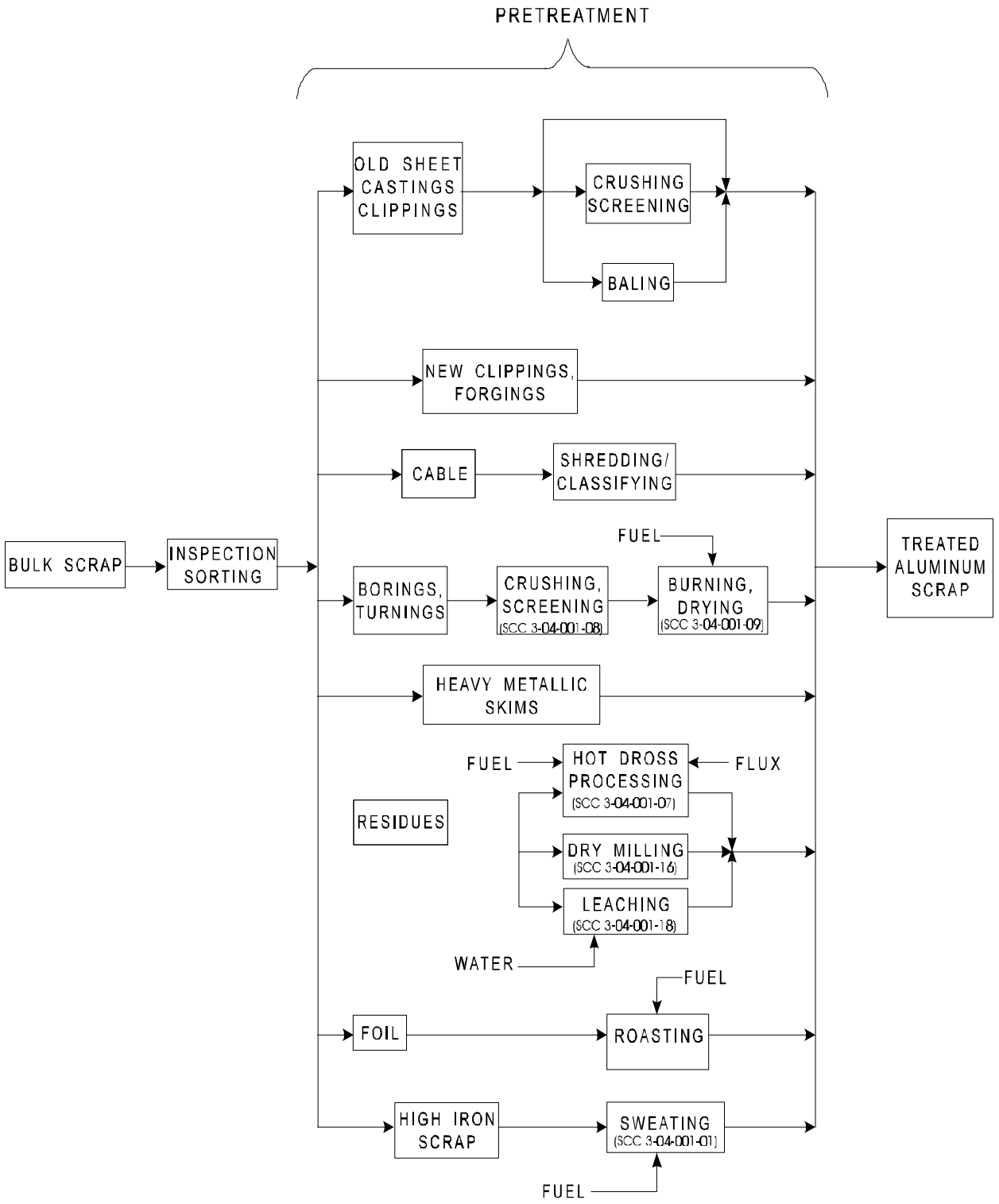

Figure 4-18a. Process Diagram for a Typical Secondary Aluminum Processing Industry

Source: Reference 59.



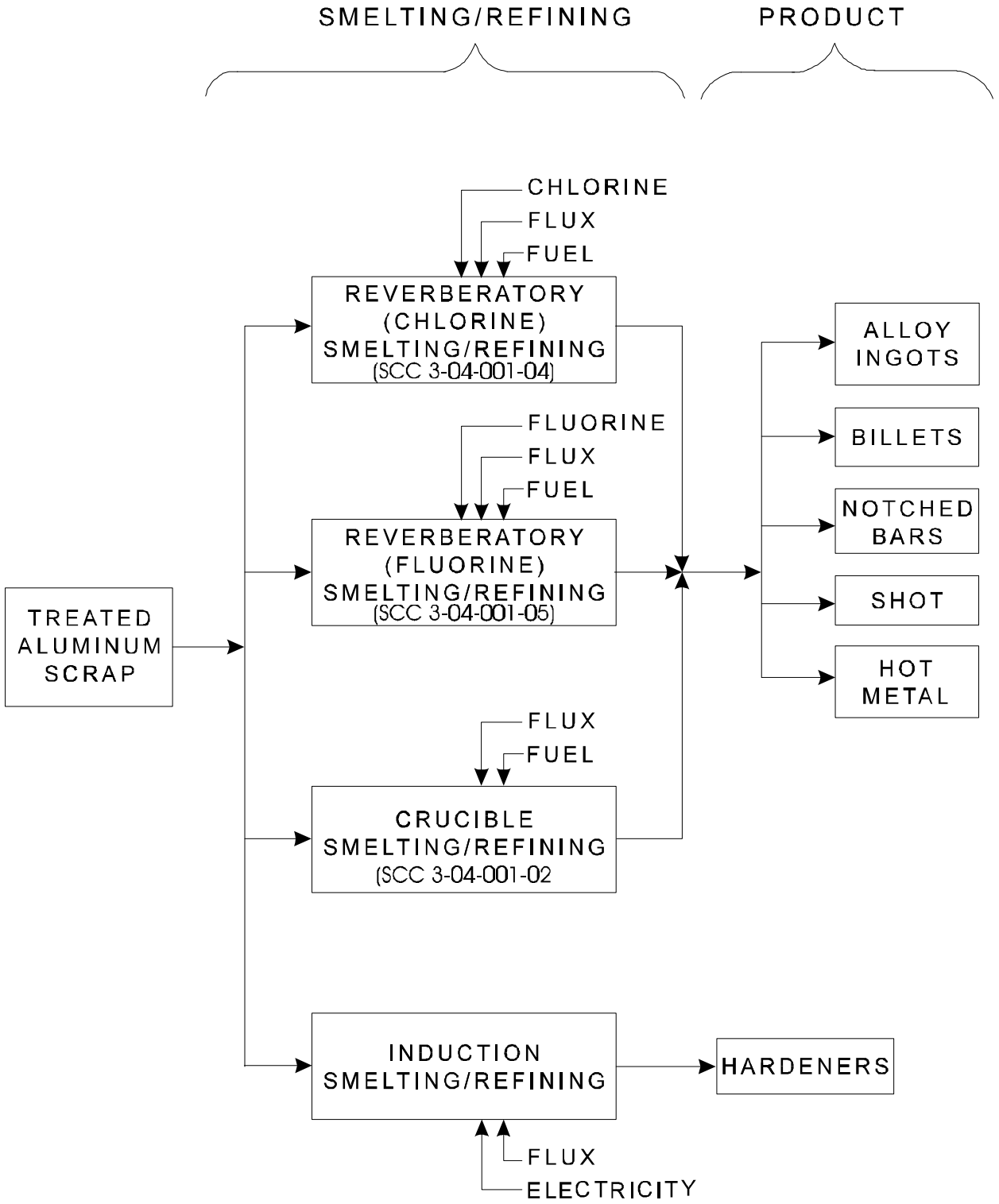

Figure 4-18b. Process for a Typical Secondary Aluminum Processing Industry  
(Source Classification Codes in parentheses)

Source: Reference 59.

An example of mechanical cleaning is the dry milling process. Cold aluminum-laden dross and other residues are processed by milling and screening to obtain a product containing at least 60 to 70 percent aluminum. Ball, rod, or hammer mills can be used to reduce oxides and nonmetallic particles to fine powders for ease of removal during screening.

*Pyrometallurgical Cleaning:* Pyrometallurgical techniques (called drying in the industry) use heat to separate aluminum from contaminants and other metals. Pyrometallurgical techniques include roasting and sweating. The roasting process involves heating aluminum scrap that contains organic contaminants in rotary dryers to temperatures high enough to vaporize or carbonize organic contaminants, but not high enough to melt aluminum (1,220°F [660°C]). An example of roasting is the APROS delacquering and preheating process used during the processing of used beverage cans (shown in Figure 4-19). The sweating process involves heating aluminum scrap containing other metals in a sweat furnace to temperatures above the melting temperature of aluminum, but below that of the other metal.<sup>59</sup>

In addition to roasting and sweating, a catalytic technique may also be used to clean aluminum dross. Dross is a layer of impurities and semisolid flux that has been skimmed from the surface of molten aluminum. Aluminum may be recovered from dross by batch fluxing with a salt/cryolite mixture in a mechanically rotated, refractory-lined barrel furnace. Cryolite acts as a catalyst that decreases aluminum surface tension and therefore increases recovery rates. Aluminum is tapped periodically through a hole in the base of the furnace.

*Hydrometallurgical Cleaning:* Hydrometallurgical techniques use water to clean and process aluminum scrap. Hydrometallurgical techniques include leaching and heavy metal separation. Leaching is used to recover aluminum from dross, furnace skimmings, and slag. It requires wet milling, screening, drying, and finally magnetic separation to remove fluxing salts and other waste products from the aluminum.

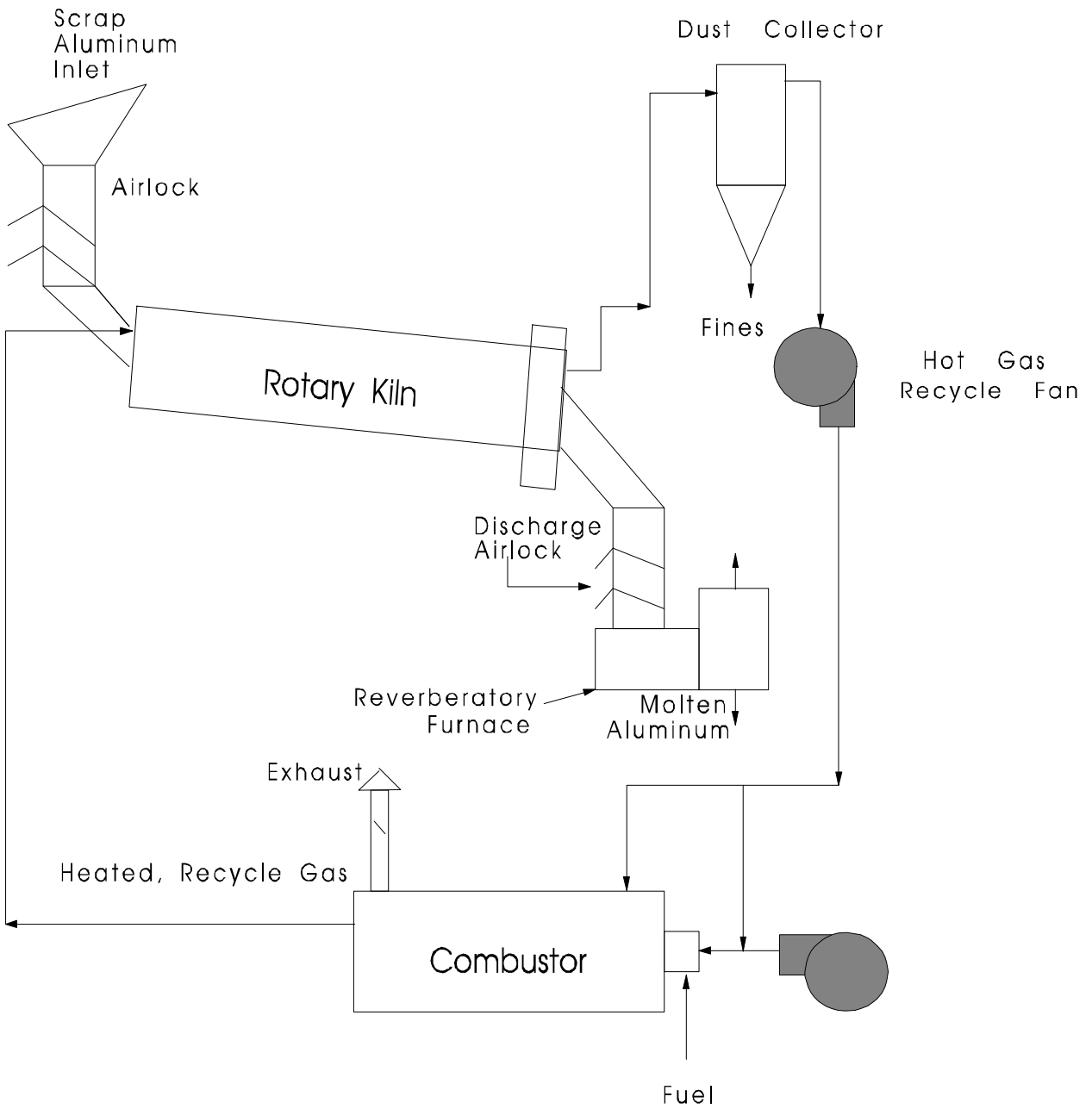

Figure 4-19. APROS Delacquering and Preheating Process

Source: Reference 59.

The heavy metal separation hydrometallurgical process separates high density metal from low density metal using a viscous medium, such as copper and iron, from aluminum. Heavy metal separation has been used to concentrate aluminum recovered from shredded cars. The cars are shredded after large aluminum components have been removed (shredded material contains approximately 30 percent aluminum) and processed in heavy media to further concentrate aluminum to 80 percent or more.

Smelting/Refining--After scrap pretreatment, smelting and refining is performed. Smelting and refining in secondary aluminum recovery takes place primarily in reverberatory furnaces. These furnaces are brick-lined and constructed with a curved roof. The term reverberatory is used because heat rising from ignited fuel is reflected (reverberated) back down from the curved furnace roof and into the melted charge. A typical reverberatory furnace has an enclosed melt area where the flame heat source operates directly above the molten aluminum. The furnace charging well is connected to the melt area by channels through which molten aluminum is pumped from the melt area into the charging well. Aluminum flows back into the melt section of the furnace under gravity.

Most secondary aluminum recovery facilities use batch processing in smelting and refining operations.<sup>59</sup> It is common for one large melting reverberatory furnace to support the flow requirements for two or more smaller holding furnaces. The melting furnace is used to melt the scrap, and remove impurities and entrained gases. The molten aluminum is then pumped into a holding furnace. Holding furnaces are better suited for final alloying, and for making any additional adjustments necessary to ensure that the aluminum meets product specifications. Pouring takes place from holding furnaces, either into molds or as feedstock for continuous casters.

Smelting and refining operations can involve the following steps: charging, melting, fluxing, demagging, degassing, alloying, skimming, and pouring.

The crucible smelting/refining process is used to melt small batches of aluminum scrap, generally limited to 1,100 lb (500 kg) or less. The metal-treating process steps are essentially the same as those of reverberatory furnaces.

The induction smelting and refining process is designed to produce aluminum alloys with increased strength and hardness by blending aluminum and hardening agents in an electric induction furnace. The process steps include charging scrap, melting, adding and blending the hardening agent, skimming, pouring, and casting into notched bars. Hardening agents include manganese and silicon.

### Emissions

The major sources of emissions from scrap pretreatment processes are scrap driers, sweat furnaces, and UBC delacquering systems.<sup>60</sup> Tables 4-24 and 4-25 present CDD/CDF emission factors for two separate delacquering systems. Control devices included a venturi scrubber (Table 4-24) and multiple cyclones (Table 4-25).

Controls--Mechanical cleaning techniques involve crushing, shredding, and screening and produce metallic and nonmetallic particulates. Burning and drying operations (pyrometallurgic techniques) emit particulates and organic vapors. Emissions from reverberatory furnaces represent a significant fraction of the total particulate and gaseous effluent generated in the secondary aluminum industry. Afterburners are frequently used to incinerate unburned VOCs. Oxidized aluminum fines blown out of the dryer by the combustion gases contain particulate emissions. Wet scrubbers or fabric filters are sometimes used in conjunction with afterburners.

Mechanically generated dust from rotating barrel dross furnaces constitutes the main air emission of hot dross processing. Some fumes are produced from the fluxing reactions.

TABLE 4-24. CDD/CDF EMISSION FACTORS FOR SECONDARY ALUMINUM SHREDDING AND DELACQUERING SYSTEM - SCRUBBER OUTLET CONTROL DEVICE - VENTURI SCRUBBER

SCC 3-04-001-09  
FACTOR QUALITY RATING: D

Pollutant	Average Emission Factor <sup>a</sup>	
	lb/ton	kg/Mg
2,3,7,8-TCDD	3.94x10 <sup>-9</sup>	1.97x10 <sup>-9</sup>
Total TCDD	9.56x10 <sup>-8</sup>	4.78x10 <sup>-8</sup>
1,2,3,7,8-PeCDD	1.42x10 <sup>-8</sup>	7.10x10 <sup>-9</sup>
Total PeCDD	1.28x10 <sup>-7</sup>	6.40x10 <sup>-8</sup>
1,2,3,4,7,8-HxCDD	8.52x10 <sup>-9</sup>	4.26x10 <sup>-9</sup>
1,2,3,6,7,8-HxCDD	1.06x10 <sup>-8</sup>	5.30x10 <sup>-9</sup>
1,2,3,7,8,9-HxCDD	1.06x10 <sup>-8</sup>	5.30x10 <sup>-9</sup>
Total HxCDD	1.56x10 <sup>-7</sup>	7.80x10 <sup>-8</sup>
1,2,3,4,6,7,8-HpCDD	5.78x10 <sup>-8</sup>	2.89x10 <sup>-8</sup>
Total HpCDD	1.17x10 <sup>-7</sup>	5.85x10 <sup>-8</sup>
Total OCDD	6.64x10 <sup>-8</sup>	3.32x10 <sup>-8</sup>
2,3,7,8-TCDF	4.64x10 <sup>-8</sup>	2.32x10 <sup>-8</sup>
Total TCDF	1.24x10 <sup>-6</sup>	6.20x10 <sup>-7</sup>
1,2,3,7,8-PeCDF	6.76x10 <sup>-8</sup>	3.38x10 <sup>-8</sup>
2,3,4,7,8-PeCDF	9.60x10 <sup>-8</sup>	4.80x10 <sup>-8</sup>
Total PeCDF	1.17x10 <sup>-6</sup>	5.85x10 <sup>-7</sup>
1,2,3,4,7,8-HxCDF	9.22x10 <sup>-8</sup>	4.61x10 <sup>-8</sup>
1,2,3,6,7,8-HxCDF	9.22x10 <sup>-8</sup>	4.61x10 <sup>-8</sup>
1,2,3,7,8,9-HxCDF	4.40x10 <sup>-8</sup>	2.20x10 <sup>-8</sup>
2,3,4,6,7,8-HxCDF	7.80x10 <sup>-8</sup>	3.90x10 <sup>-8</sup>
Total HxCDF	1.03x10 <sup>-6</sup>	5.15x10 <sup>-7</sup>
1,2,3,4,6,7,8-HpCDF	2.44x10 <sup>-7</sup>	1.22x10 <sup>-7</sup>
1,2,3,4,7,8,9-HpCDF	5.42x10 <sup>-8</sup>	2.71x10 <sup>-8</sup>
Total HpCDF	4.94x10 <sup>-7</sup>	2.47x10 <sup>-7</sup>
Total OCDF	1.21x10 <sup>-7</sup>	6.05x10 <sup>-8</sup>
Total CDD	5.62x10 <sup>-7</sup>	2.81x10 <sup>-7</sup>
Total CDF	4.04x10 <sup>-6</sup>	2.02x10 <sup>-6</sup>

Source: Reference 60.

<sup>a</sup> Emission factors are lb (kg) of pollutant emitted per ton (Mg) of aluminum produced.

TABLE 4-25. CDD/CDF EMISSION FACTORS FOR SECONDARY ALUMINUM SHREDDING AND DELACQUERING SYSTEM CONTROL DEVICE - MULTIPLE CYCLONES

SCC 3-04-001-09  
 FACTOR QUALITY RATING: D

Pollutant	Average Emission Factor <sup>a</sup>	
	lb/ton	kg/Mg
2,3,7,8-TCDD	1.69x10 <sup>-9</sup>	8.45x10 <sup>-10</sup>
1,2,3,7,8-PeCDD	7.28x10 <sup>-9</sup>	3.64x10 <sup>-9</sup>
1,2,3,4,7,8-HxCDD	5.64x10 <sup>-9</sup>	2.82x10 <sup>-9</sup>
1,2,3,6,7,8-HxCDD	8.24x10 <sup>-9</sup>	4.12x10 <sup>-9</sup>
1,2,3,7,8,9-HxCDD	4.04x10 <sup>-9</sup>	2.02x10 <sup>-9</sup>
Total HxCDD	1.79x10 <sup>-8</sup>	8.95x10 <sup>-9</sup>
1,2,3,4,6,7,8-HpCDD	3.86x10 <sup>-8</sup>	1.93x10 <sup>-8</sup>
Total OCDD	4.86x10 <sup>-8</sup>	2.43x10 <sup>-8</sup>
2,3,7,8-TCDF	9.68x10 <sup>-9</sup>	4.84x10 <sup>-9</sup>
1,2,3,7,8-PeCDF	2.36x10 <sup>-8</sup>	1.18x10 <sup>-9</sup>
2,3,4,7,8-PeCDF	4.66x10 <sup>-8</sup>	2.33x10 <sup>-8</sup>
Total PeCDF	7.02x10 <sup>-8</sup>	3.51x10 <sup>-8</sup>
1,2,3,4,7,8-HxCDF	3.52x10 <sup>-8</sup>	1.76x10 <sup>-8</sup>
1,2,3,6,7,8-HxCDF	3.38x10 <sup>-8</sup>	1.69x10 <sup>-8</sup>
1,2,3,7,8,9-HxCDF	2.70x10 <sup>-9</sup>	1.35x10 <sup>-9</sup>
2,3,4,6,7,8-HxCDF	3.20x10 <sup>-8</sup>	1.60x10 <sup>-8</sup>
Total HxCDF	1.04x10 <sup>-7</sup>	5.20x10 <sup>-8</sup>
1,2,3,4,6,7,8-HpCDF	8.52x10 <sup>-8</sup>	4.26x10 <sup>-8</sup>
1,2,3,4,7,8,9-HpCDF	1.24x10 <sup>-8</sup>	6.20x10 <sup>-9</sup>
Total HpCDF	9.76x10 <sup>-8</sup>	4.88x10 <sup>-8</sup>
Total OCDF	5.90x10 <sup>-8</sup>	2.95x10 <sup>-8</sup>
Total CDD	1.14x10 <sup>-7</sup>	5.70x10 <sup>-8</sup>
Total CDF	3.40x10 <sup>-7</sup>	1.70x10 <sup>-7</sup>

Source: Reference 61.

<sup>a</sup> Emission factors are lb (kg) of pollutant emitted per ton (Mg) of aluminum produced.

Fugitive emissions are controlled by enclosing the barrel furnace in a hood system and by ducting the emissions to a fabric filter. Furnace offgas emissions, mainly fluxing salt fume, are often controlled by a venturi scrubber.

#### 4.5.3 Secondary Lead Production

In 1990, primary and secondary smelters in the United States produced 1,380,000 tons (1,255,000 Mg) of lead. Secondary lead smelters produced 948,000 tons (860,000 Mg) or about 69 percent of the total refined lead produced in 1990; primary smelters produced 434,000 tons (395,000 Mg).<sup>62</sup> Table 4-26 lists U.S. secondary lead smelters according to their annual lead production capacity.

##### Process Description

The secondary lead smelting industry produces elemental lead and lead alloys by reclaiming lead, mainly from scrap automobile batteries. Blast, reverberatory, rotary, and electric furnaces are used for smelting scrap lead and producing secondary lead. Smelting is the reduction of lead compounds to elemental lead in a high-temperature furnace. It requires higher temperatures (2,200 to 2,300°F [1,200 to 1,260°C]) than those required for melting elemental lead (621°F [327°C]). Secondary lead may be refined to produce soft lead (which is nearly pure lead) or alloyed to produce hard lead alloys. Fifty percent of the lead produced by secondary lead smelters is hard lead, and fifty percent is soft. About 80 percent of all lead in the United States goes to producing new batteries.<sup>62</sup>

Lead-acid batteries represent about 90 percent of the raw materials at a typical secondary lead smelter, although this percentage may vary from one plant to the next. These batteries contain approximately 18 lb (8.2 kg) of lead per battery consisting of 40 percent lead alloys and 60 percent lead oxide. Other types of lead-bearing raw materials recycled by secondary lead smelters include drosses (lead-containing byproducts of lead refining), which may be



TABLE 4-26. U.S. SECONDARY LEAD SMELTERS

Smelter	Location
<u>Small Capacity:</u> less than 22,000 ton/yr (20,000 Mg/yr)	
Delatte Metals	Ponchatoula, LA
General Smelting and Refining Company	College Grove, TN
Master Metals, Inc.	Cleveland, OH
Metals Control of Kansas	Hillsboro, KS
Metals Control of Oklahoma	Muskogee, OK
<u>Medium Capacity:</u> 22,000 to 82,000 ton/yr (20,000 to 75,000 Mg/yr)	
Doe Run Company	Boss, MO
East Penn Manufacturing Company	Lyon Station, PA
Exide Corporation	Muncie, IN
Exide Corporation	Reading, PA
GNB, Inc.	Columbus, GA
GNB, Inc.	Frisco, TX
Gulf Coast Recycling, Inc.	Tampa, FL
Refined Metals Corporation	Beech Grove, IN
Refined Metals Corporation	Memphis, TN
RSR Corporation	City of Industry, CA
RSR Corporation	Middletown, NY
Schuylkill Metals Corporation	Forest City, MO
Tejas Resources, Inc.	Terrell, TX
<u>Large Capacity:</u> greater than 82,000 ton/yr (75,000 Mg/yr)	
Gopher Smelting and Refining, Inc.	Eagen, MN
GNB, Inc.	Vernon, CA
RSR Corporation	Indianapolis, IN
Sanders Lead Company	Troy, AL
Schuylkill Metals Corporation	Baton Rouge, LA

Source: Reference 62.

purchased from companies that perform lead alloying or refining but not smelting; battery plant scrap, such as defective grids or paste; and scrap lead, such as old pipes or roof flashing. Other scrap lead sources include cable sheathing, solder, and babbitt metal.<sup>62</sup>

As illustrated in Figure 4-20, the normal sequence of operations in a secondary lead smelter is scrap receiving, charge preparation, furnace smelting, and lead refining and alloying. In all plants, scrap batteries are first sawed or broken open to remove the lead alloy plates and lead oxide paste material. At blast furnace smelters, a slow-speed saw is used to remove the top of the case, the plates are dumped from the case, and whole grids are charged to the furnace. At other types of smelters, hammermills or other crushing/shredding devices are used to break open the battery cases. Float/sink separation systems are typically used to separate plastic battery parts, lead terminals, lead oxide paste, and hard rubber used in older batteries. The majority of lead smelters recover the crushed polypropylene plastic materials for recycling. Hard rubber materials are usually charged to the furnace.

Paste desulfurization is an optional feed material processing step used by some secondary lead smelters. It involves the separation of lead sulfate and lead oxide paste from the lead grid metal, polypropylene plastic cases, separators, and hard rubber battery cases. The next step is the chemical conversion of lead sulfate in the lead battery paste to lead oxide. This process improves furnace efficiency by reducing the need for fluxing agents to reduce lead-sulfur compounds to lead metal. The process also reduces SO<sub>2</sub> furnace emissions. However, SO<sub>2</sub> emissions reduction is usually a less important consideration because many plants that perform paste desulfurization are also equipped with SO<sub>2</sub> scrubbers. About half of all smelters perform paste desulfurization.<sup>62</sup>

After removing the lead components from the scrap batteries, the lead scrap is combined with other charge materials such as refining drosses, flue dust, furnace slag, coke, limestone, and sand and fed to either a reverberatory, blast, rotary or electric smelting furnace.

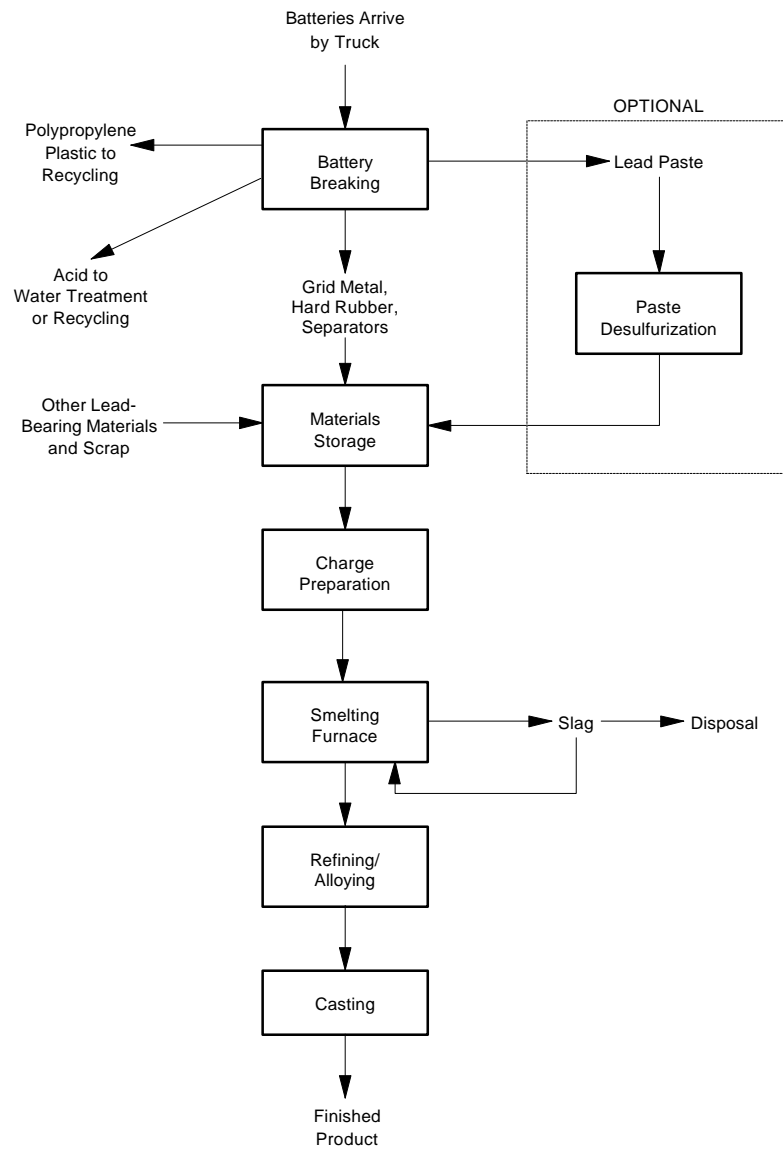

Figure 4-20. Simplified Process Flow Diagram for Secondary Lead Smelting

Source: Reference 62.

Smelting furnaces are used to produce crude lead bullion, which is refined and/or alloyed into final lead products.

Refining, the final step in secondary lead production, consists of removing impurities and adding alloying metals to the molten lead obtained from the smelting furnaces to meet a customer's specifications. Refining kettles are used for the purifying and alloying of molten lead.

Blast and reverberatory furnaces are currently the most common types of smelting furnaces in the industry, although some new plants are using rotary furnaces. There are approximately 15 reverberatory furnaces, 24 blast furnaces, 5 rotary furnaces, and 1 electric furnace in the secondary lead industry.<sup>62</sup> The following discussion provides process descriptions of these four types of secondary lead smelters.

Reverberating Furnaces--A reverberatory furnace as shown in Figure 4-21, is a rectangular refractory-lined furnace. Reverberatory furnaces are operated on a continuous basis. Natural gas- or fuel oil-fired jets located at one end or at the sides of the furnace are used to heat the furnace and charge material to an operating temperature of about 2,000°F (1,100°C). Oxygen enrichment may be used to decrease the combustion air requirements. Reverberatory furnaces are maintained at negative pressure by an induced draft fan.

Reverberatory furnace charge materials include battery grids and paste, battery plant scrap, rerun reverberatory furnace slag, flue dust, drosses, iron, silica, and coke. A typical charge over one hour may include 9.3 tons (8.4 Mg) of grids and paste to produce 6.2 tons (5.6 Mg) of lead.<sup>62</sup>

Charge materials are often fed to a natural gas- or oil-fired rotary drying kiln, which dries the material before it reaches the reverberatory furnace. The temperature of the drying kiln is about 400°F (200°C), and the drying kiln exhaust is drawn directly into the

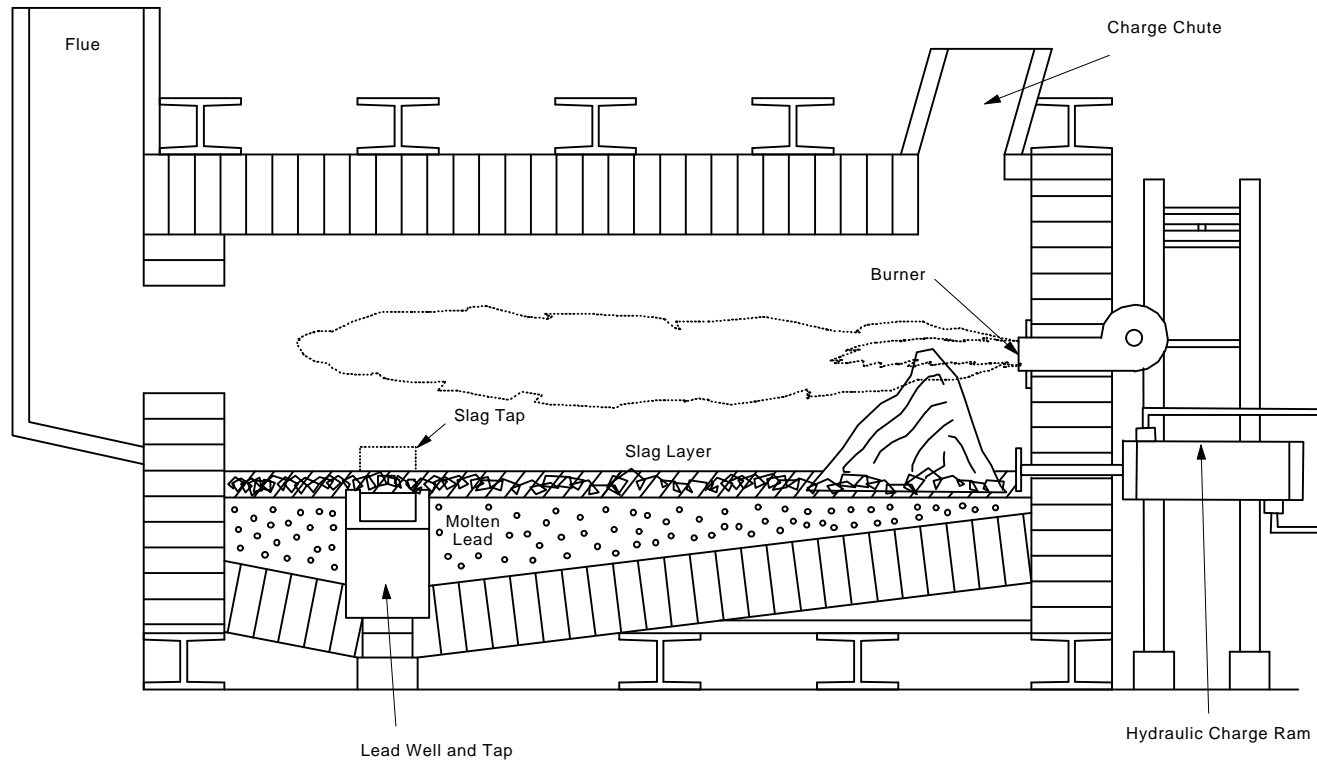
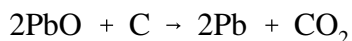
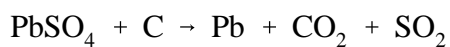

Figure 4-21. Cross-sectional View of a Typical Stationary Reverberatory Furnace

Source: Reference 62.

reverberatory furnace or ventilated to a control device. From the rotary drying kiln, the feed is either dropped into the top of the furnace through a charging chute, or fed into the furnace at fixed intervals with a hydraulic ram. In furnaces that use a feed chute, a hydraulic ram is often used as a stoker to move the material down the furnace.<sup>62</sup>

Reverberatory furnaces are used to produce a soft (nearly pure) lead product and a lead-bearing slag. This is done by controlling the reducing conditions in the furnace so that lead components are reduced to metallic lead bullion and the alloying elements (antimony, tin, arsenic) in the battery grids, posts, straps, and connectors are oxidized and removed in the slag. The reduction of  $\text{PbSO}_4$  and  $\text{PbO}$  is promoted by the carbon-containing coke added to the charge material:



The  $\text{PbSO}_4$  and  $\text{PbO}$  also react with the alloying elements to form lead bullion and oxides of the alloying elements; the latter are removed in the slag.

The molten lead collects in a pool at the lowest part of the hearth. Slag collects in a layer on top of this pool and retards further oxidation of the lead. The slag is made up of molten fluxing agents such as iron, silica, and lime, and typically has significant quantities of lead. Slag is usually tapped continuously and lead is tapped intermittently. The slag is tapped into a crucible. The slag tap and crucible are hooded and vented to a control device. Reverberatory furnace slag usually has a high lead content (as much as 70 percent by weight) and is used as feed material in a blast or electric furnace to recover the lead content. Reverberatory furnace slag may also be rerun through the reverberatory furnace during special slag campaigns before being sent to a blast or electric furnace. Lead may be tapped into a crucible or directly into a holding kettle. The lead tap is usually hooded and vented to a control device.<sup>62</sup>

Blast Furnaces--A blast furnace as shown in Figure 4-22, is a vertical furnace that consists of a crucible with a vertical cylinder affixed to the top. The crucible is refractory-lined and the vertical cylinder consists of a steel water jacket. Oxygen-enriched combustion air is introduced into the furnace through tuyeres located around the base of the cylinder.

Charge materials are pre-weighed to ensure the proper mixture and then introduced into the top of the cylinder using a skip hoist, a conveyor, or a front-end loader. The charge fills nearly the entire cylinder. Charge material is added periodically to keep the level of the charge at a consistent working height while lead and slag are tapped from the crucible. Coke is added to the charge as the primary fuel, although natural gas jets may be used to start the combustion process. Combustion is self-sustaining as long as there is sufficient coke in the charge material. Combustion occurs in the layer of the charge nearest the tuyeres.

At plants that operate only blast furnaces, the lead-bearing charge materials may include broken battery components, drosses from the refining kettles, agglomerated flue dust, and lead-bearing slag. A typical charge over one hour may include 4.8 tons (4.4 Mg) of grids and paste, 0.3 tons (0.3 Mg) of coke, 0.1 tons (0.1 Mg) of calcium carbonate, 0.07 tons (0.06 Mg) of silica, 0.5 tons (0.4 Mg) of cast iron, and 0.2 tons (0.2 Mg) of rerun blast furnace slag, to produce 3.7 tons (3.3 Mg) of lead. At plants that also have a reverberatory furnace, the charge materials will also include lead-bearing reverberatory furnace slag.<sup>62</sup>

Blast furnaces are designed and operated to produce a hard (high alloy content) lead product by achieving more reducing furnace conditions than those typically found in a reverberatory furnace. Fluxing agents include iron, soda ash, limestone, and silica (sand). The oxidation of the iron, limestone, and silica promotes the reduction of lead compounds and prevents oxidation of the lead and other metals. The soda ash enhances the reaction of  $\text{PbSO}_4$  and  $\text{PbO}$  with carbon from the coke to reduce these compounds to lead metal.

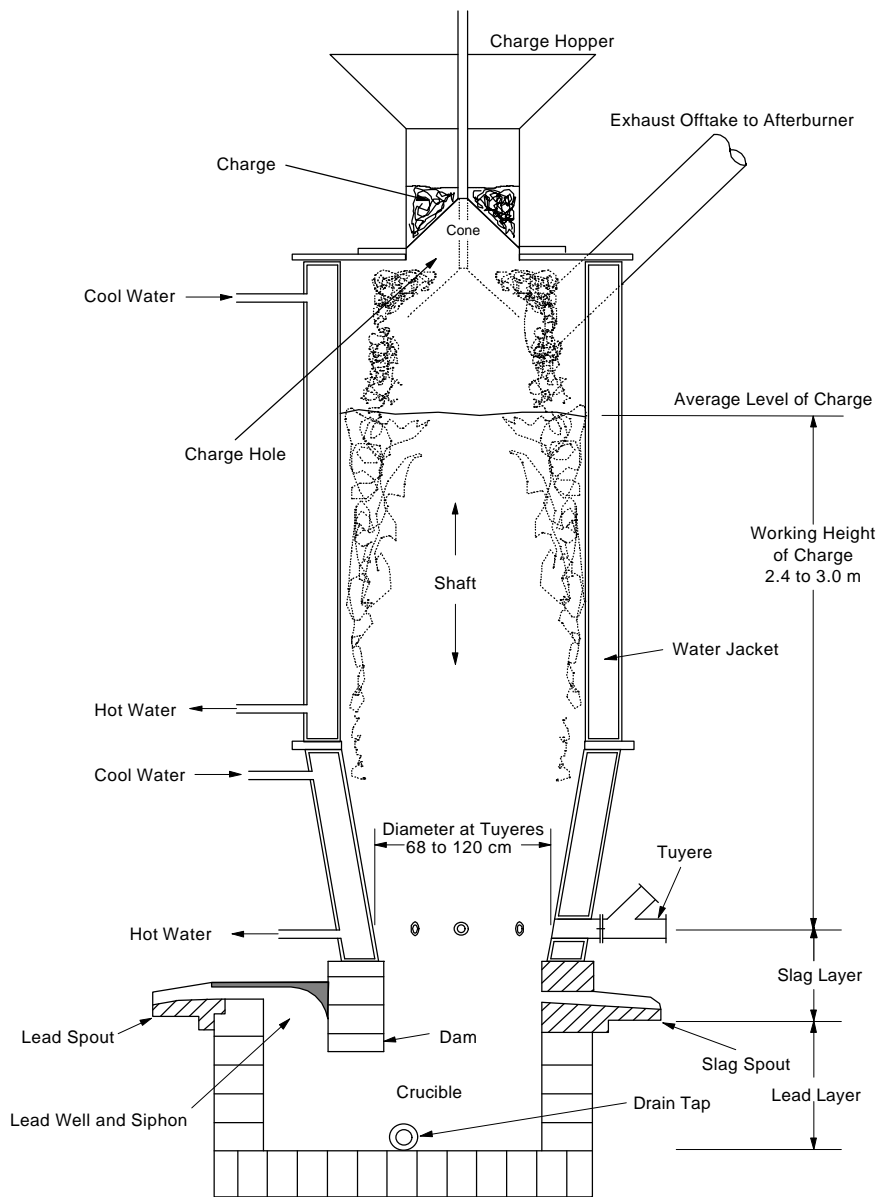

Figure 4-22. Cross-section of a Typical Blast Furnace

Source: Reference 62.



Lead tapped from a blast furnace has a higher content of alloying metals (up to 25 percent) than lead produced by a reverberatory furnace. In addition, much less of the lead and alloying metals are oxidized and removed in the slag, so the slag has a low metal content (e.g., 1 to 3 percent) and frequently qualifies as a nonhazardous solid waste.

Because air is introduced into the blast furnace at the tuyeres, blast furnaces are operated at positive pressure. The operating temperature at the combustion layer of the charge is between 2,200 and 2,600°F (1,200 and 1,400°C), but the temperature of the gases exiting the top of the charge material is only between 750 and 950°F (400 and 500°C).

Molten lead collects in the crucible beneath a layer of molten slag. As in a reverberatory furnace, the slag inhibits the further oxidation of the molten metal. Lead is tapped continuously and slag is tapped intermittently, slightly before it reaches the level of the tuyeres. If the tuyeres become blocked with slag, they are manually or automatically "punched" to clear the slag. A sight glass on the tuyeres allows the furnace operator to monitor the slag level and ensure that they are clear of slag. At most facilities, the slag tap is temporarily sealed with a clay plug, which is driven out to begin the flow of slag from the tap into a crucible. The slag tap and crucible are enclosed in a hood, which is vented to a control device.

A weir dam and siphon in the furnace are used to remove the lead from beneath the slag layer. Lead is tapped from a blast furnace into either a crucible or directly to a refining kettle designated as a holding kettle. The lead in the holding kettle is kept molten before being pumped to a refining kettle for refining and alloying. The lead tap on a blast furnace is hooded and vented to a control device.

Rotary Furnaces--As noted above, rotary furnaces (sometimes referred to as rotary reverberatory furnaces) (Figure 4-23) are used at only a few recently constructed secondary lead smelters in the United States. Rotary furnaces have two advantages over other furnace types: it is easier to adjust the relative amount of fluxing agents because the furnaces are operated on a

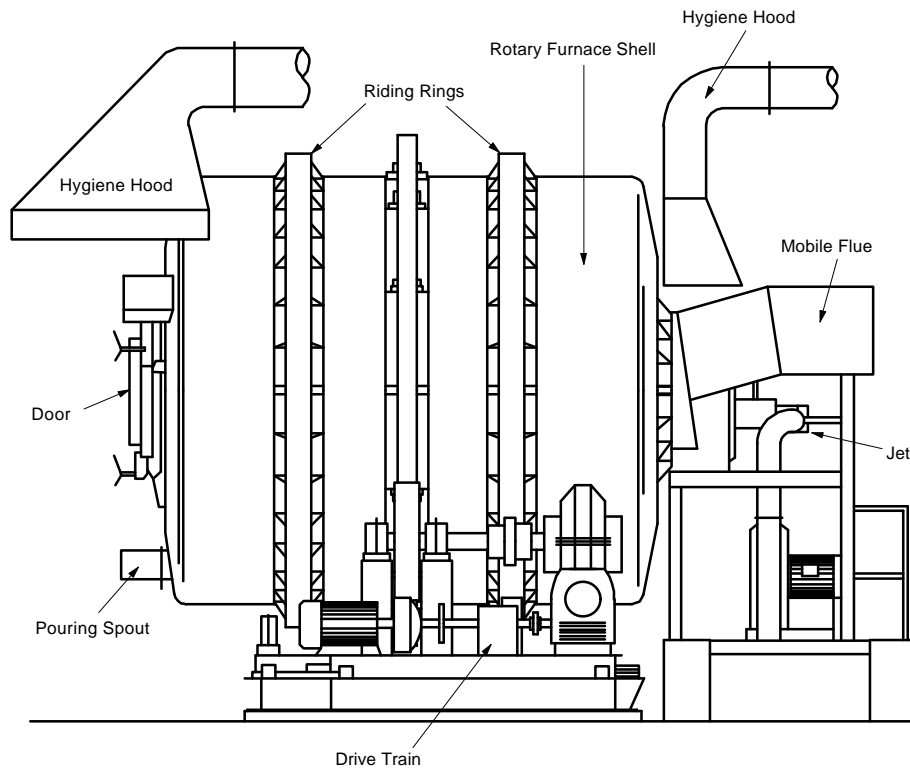

Figure 4-23. Side-view of a Typical Rotary Reverberatory Furnace

Source: Reference 62.

batch rather than a continuous basis, and they achieve better mixing of the charge materials than do blast or reverberatory furnaces.<sup>62</sup>

A rotary furnace consists of a refractory-lined steel drum mounted on rollers. Variable-speed motors are used to rotate the drum. An oxygen-enriched natural gas or fuel oil jet at one end of the furnace heats the charge material and the refractory lining of the drum. The connection to the flue is located at the same end as the jet. A sliding door at the end of the furnace opposite from the jet allows charging of material to the furnace. Charge materials are typically placed in the furnace using a retractable conveyor or charge bucket, although other methods are possible.

Lead-bearing raw materials charged to rotary furnaces include broken battery components, flue dust, and drosses. Rotary furnaces can use the same lead-bearing raw materials as reverberatory furnaces, but they produce slag that is relatively free of lead, less than 2 percent. As a result, a blast furnace is not needed for recovering lead from the slag, which may be disposed of as a nonhazardous waste.

Fluxing agents for rotary furnaces may include iron, silica, soda ash, limestone, and coke. The fluxing agents are added to promote the conversion of lead compounds to lead metal. Coke is used as a reducing agent rather than as a primary fuel. A typical charge may consist of 12 tons (11 Mg) of wet battery scrap, 0.8 tons (0.7 Mg) of soda ash, 0.6 tons (0.5 Mg) of coke, and 0.6 tons (0.5 Mg) of iron. This charge will yield approximately 9 tons (8 Mg) of lead product.<sup>62</sup>

The lead produced by rotary furnaces is a semi-soft lead with an antimony content somewhere between that of lead from reverberatory and blast furnaces. Lead and slag are tapped from the furnace at the conclusion of the smelting cycle. Each batch takes 5 to 12 hours to process, depending on the size of the furnace. Like reverberatory furnaces, rotary furnaces are operated at a slightly negative pressure.

Electric Furnaces--An electric furnace consists of a large, steel, kettle-shaped container that is refractory-lined (Figure 4-24). A cathode extends downward into the container and an anode is located in the bottom of the container. Second-run reverberatory furnace slag is charged into the top of the furnace. Lead and slag are tapped from the bottom and side of the furnace, respectively. A fume hood covering the top of the furnace is vented to a control device.

In an electric furnace, electric current flows from the cathode to the anode through the scrap charge. The electrical resistance of the charge causes the charge to heat up and become molten. There is no combustion process involved in an electric furnace<sup>62</sup>.

There is only one electric furnace in operation in the U.S. secondary lead industry. It is used to process second-run reverberatory furnace slag, and it fulfills the same role as a blast furnace used in conjunction with a reverberatory furnace. However, the electric furnace has two advantages over a blast furnace. First, because there are no combustion gases, ventilation requirements are much lower than for blast or reverberatory furnaces, and the potential for formation of organics is greatly reduced. Second, the electric furnace is extremely reducing, and produces a glass-like, nearly lead-free slag that is nonhazardous.

#### Emission Control Techniques

Controls used to reduce organic emissions from smelting furnaces in the secondary lead smelting industry include afterburners on blast furnaces and combined blast and reverberatory exhausts. Reverberatory and rotary furnaces have minimal dioxin/furan emissions because of high exhaust temperatures and turbulence, which promote complete combustion of organics. No controls for total hydrocarbons (THC) are necessary for these process configurations.<sup>62</sup>

CDD/CDF emissions from blast furnaces are dependent on the type of add-on control used. An afterburner operated at 1,300°F (700°C) achieves about 84 percent destruction efficiency of total hydrocarbons (THC).<sup>62</sup> Several facilities with blast and reverberatory furnaces

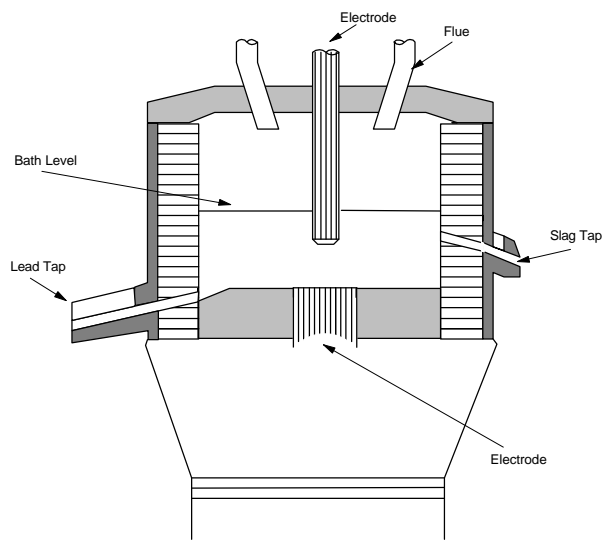

Figure 4-24. Cross-section View of an Electrical Furnace for Processing Slag

Source: Reference 62.

combine the exhaust streams and vent the combined stream to an afterburner. The higher operating temperature of the reverberatory furnace reduces the fuel needs of the afterburner so that the afterburner is essentially "idling." Any temperature increase measured across the afterburner is due to the heating value of organic compounds in the blast furnace exhaust. A combined reverberatory and blast furnace exhaust stream ducted to an afterburner with an exit temperature of 1,700°F (930°C) can achieve 99 percent destruction efficiency for THC.<sup>62</sup>

Additional controls used by secondary lead smelters include baghouses for particulate and metal control, hooding and ventilation to a baghouse for process fugitives, and scrubbers for HCl and SO<sub>2</sub> control.<sup>62</sup>

#### Emission Factors

Process emissions (i.e., those emitted from the smelting furnace's main exhaust) contain metals, organics (including dioxins/furans), hydrogen chloride (HCl), and chlorine (Cl<sub>2</sub>). Process emissions also contain criteria pollutants, including PM, VOCs, CO, and SO<sub>2</sub>. The primary source of CDD/CDF at secondary lead smelters is PVC used as separators in lead-acid batteries. The Battery Council International (BCI) recently provided EPA with data (gathered in 1995) showing that less than one-tenth of one percent of U.S.-manufactured batteries were found to contain PVC separators.<sup>63</sup> It is important to note here that BCI also reports that no U.S. manufacturer of lead-acid automotive batteries currently uses PVC in production.<sup>63</sup>

Blast furnaces are greater sources of dioxin/furan emissions than reverberatory or rotary furnaces. Low exhaust temperatures from the charge column [about 800°F (430°C)] result in the formation of products of incomplete combustion (PIC) from the organic material in the feed material. Uncontrolled THC emissions (which correlate closely with organic pollutant emissions) from a typical 55,000-ton/yr (50,000 Mg/yr) blast furnace are about 309 tons/yr (280 Mg/yr).<sup>62</sup>

The EPA does not have sufficient data to link dioxin/furan emissions to specific control technologies currently in use in the industry.<sup>62</sup> Rotary and reverberatory furnaces have much higher exhaust temperatures than blast furnaces, about 1,800 to 2,200°F (980 to 1,200°C), and much lower THC emissions because of more complete combustion. Total hydrocarbon emissions from a typical rotary furnace (16,500 ton/yr [15,000 Mg/yr] capacity) are about 38 ton/yr (34 Mg/yr). The majority of these emissions occur during furnace charging, when the furnace's burner is cut back and the temperature is reduced. Emissions drop off sharply when charging is completed and the furnace is brought to normal operating temperature.<sup>62</sup> CDD/CDF emissions from reverberatory furnaces are even lower than those from rotary furnaces because reverberatory furnaces are operated continuously rather than on a batch basis.

Three test reports from three secondary lead smelters were used to develop CDD/CDF emission factors.<sup>64-66</sup> All testing was conducted in support of the EPA's Secondary Lead National Emission Standards for Hazardous Air Pollutants (NESHAP) program. The three facilities tested represent the following process configurations: a rotary smelting furnace equipped with a baghouse and SO<sub>2</sub> scrubber; a blast furnace equipped with an afterburner, baghouse, and SO<sub>2</sub> scrubber; and a reverberatory and blast furnace with exhaust from each furnace combined prior to a single afterburner, baghouse, and SO<sub>2</sub> scrubber.

Emissions were measured at all three facilities, and emission factors were derived from the test reports of the three facilities representing the three principal furnace types in use. These emission factors represent emissions with a baghouse and scrubber, and are shown in Table 4-27. However, the effect of these controls on CDD/CDF emissions is unclear.

#### 4.5.4 Scrap Metal Incinerators

Scrap metal incinerators are used to burn off combustible contaminants (e.g., plastics, rubber, paper, oils) contained in scrap metal. This process renders a cleaner metal scrap that can be further processed into a refined, saleable metal product. Scrap metal

TABLE 4-27. CDD/CDF EMISSION FACTORS FOR SECONDARY LEAD SMELTING

SCC 3-04-004-02, -03, -04  
 FACTOR QUALITY RATING: D

Isomer	Emission Factor lb/ton (kg/Mg) <sup>a</sup>	
	Baghouse Outlet	Scrubber Outlet
<b>ROTARY FURNACE (3-04-004-04)</b>		
2,3,7,8-TCDD	3.16x10 <sup>-10</sup> (1.58x10 <sup>-10</sup> )	3.96x10 <sup>-10</sup> (1.98x10 <sup>-10</sup> )
2,3,7,8-TCDF	2.00x10 <sup>-9</sup> (1.00x10 <sup>-9</sup> )	2.00x10 <sup>-9</sup> (1.00x10 <sup>-9</sup> )
2,3,7,8-TCDD TEQ	1.42x10 <sup>-9</sup> (7.10x10 <sup>-10</sup> )	1.21x10 <sup>-10</sup> (6.05x10 <sup>-11</sup> )
Total CDD	1.49x10 <sup>-8</sup> (7.45x10 <sup>-9</sup> )	1.85x10 <sup>-9</sup> (9.25x10 <sup>-10</sup> )
Total CDF	5.16x10 <sup>-8</sup> (2.58x10 <sup>-8</sup> )	5.16x10 <sup>-8</sup> (2.58x10 <sup>-8</sup> )
<b>BLAST FURNACE (3-04-004-03)</b>		
2,3,7,8-TCDD	4.46x10 <sup>-9</sup> (2.23x10 <sup>-9</sup> )	5.38x10 <sup>-10</sup> (2.69x10 <sup>-10</sup> )
2,3,7,8-TCDF	1.85x10 <sup>-8</sup> (9.25x10 <sup>-9</sup> )	1.97x10 <sup>-9</sup> (9.85x10 <sup>-10</sup> )
2,3,7,8-TCDD TEQ	1.76x10 <sup>-8</sup> (8.80x10 <sup>-9</sup> )	1.68x10 <sup>-9</sup> (8.40x10 <sup>-10</sup> )
Total CDD	2.94x10 <sup>-7</sup> (1.47x10 <sup>-7</sup> )	2.26x10 <sup>-8</sup> (1.13x10 <sup>-8</sup> )
Total CDF	5.10x10 <sup>-7</sup> (2.55x10 <sup>-7</sup> )	4.74x10 <sup>-8</sup> (2.37x10 <sup>-8</sup> )
<b>BLAST/REVERB FURNACE (3-04-004-02)</b>		
2,3,7,8-TCDD	1.48x10 <sup>-10</sup> (7.40x10 <sup>-11</sup> )	1.75x10 <sup>-10</sup> (8.75x10 <sup>-11</sup> )
2,3,7,8-TCDF	8.34x10 <sup>-9</sup> (4.67x10 <sup>-9</sup> )	2.88x10 <sup>-9</sup> (1.44x10 <sup>-9</sup> )
2,3,7,8-TCDD TEQ	2.68x10 <sup>-9</sup> (1.34x10 <sup>-9</sup> )	8.14x10 <sup>-10</sup> (4.07x10 <sup>-10</sup> )
Total CDD	1.12x10 <sup>-8</sup> (5.60x10 <sup>-9</sup> )	1.42x10 <sup>-8</sup> (7.10x10 <sup>-9</sup> )
Total CDF	7.66x10 <sup>-8</sup> (3.83x10 <sup>-8</sup> )	3.16x10 <sup>-8</sup> (1.58x10 <sup>-8</sup> )

Source: References 64-67.

<sup>a</sup> Emission factors are in lb (kg) of pollutant emitted per ton (Mg) of lead produced.



incinerators operate in an oxidizing atmosphere, as opposed to metal smelters, which operate in a reducing atmosphere. The purpose of a scrap metal incinerator is simply to burn off contaminants prior to smelting.

### Process Description

Many types of scrap materials are processed in incinerators prior to smelting, including wire and cable, drained transformer cores, automobile bodies, electric motors, and various other types of metal-bearing scrap. The combustible portion of scrap metal comprises a great variety of materials, including rubber, paper, cotton, asphalt-impregnated fabrics, silk, and plastics such as polyethylene, polypropylene and PVC. Additionally, the metals themselves may have baked-on coatings of plastic, paint, or varnish. The chlorine present in PVC wire insulation or automobile parts and other sources of chlorinated organic materials provide sufficient chlorine to produce CDD/CDF from the combustion of these materials.<sup>68</sup>

Figure 4-25 shows a process flow diagram of a scrap metal reclamation incinerator. There are many different designs of scrap metal reclamation incinerators; however, there are some commonalities. A typical scrap metal reclamation incinerator consists of one or more chambers and an afterburner connected to a stack. The older designs are normally limited to a single primary or charging chamber and afterburner. Newer designs generally incorporate a secondary or settling chamber prior to the afterburner. The designs also differ in the placement of burners and use of water sprays for quenching.<sup>69</sup>

A typical scrap reclamation incinerator is operated in batch mode 8 hours per day, 5 days per week. However, operation is variable and largely dependent on scrap availability. At the beginning of a batch, a charge of scrap material is placed in the primary chamber and is ignited using paper or the primary chamber burner, if one exists. Gases from the primary chamber flow through the secondary chamber, where some settling of large particulate occurs, and then to the afterburner, where the flue gases are heated to 1,800° to 2,000°F (980° to 1090°C) to control

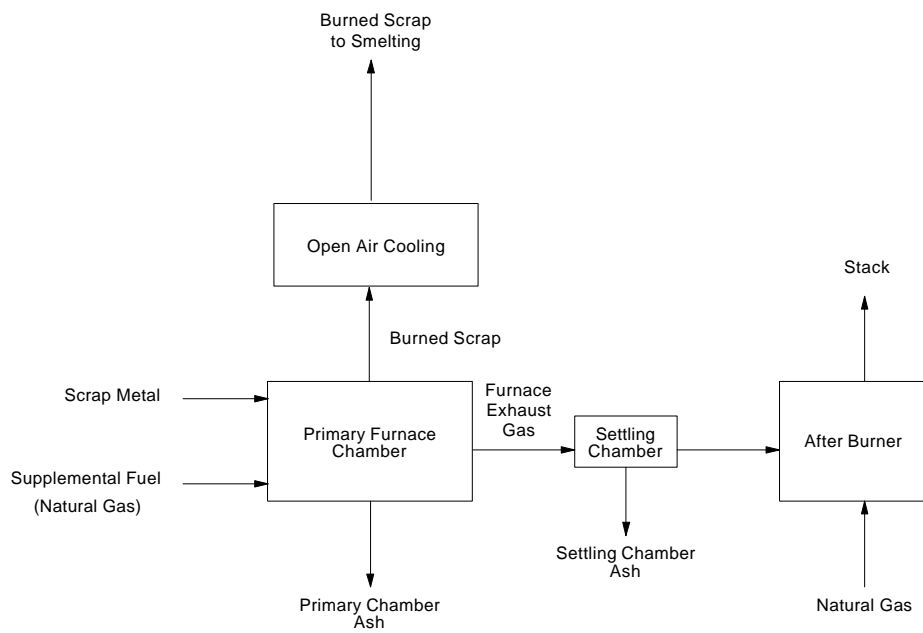

Figure 4-25. Scrap Metal Incinerator Process Flow Diagram

Source: Reference 69.

emissions prior to discharge to the atmosphere. Natural gas is typically used as the auxiliary fuel for a scrap incinerator; however, liquid propane or No. 2 fuel oil can be used.

Most incinerators operate with very little or no instrumentation to measure temperature or control draft and oxygen level. Combustion conditions can be controlled by varying the amount of air allowed into the primary chamber during combustion. The amount of air is controlled by opening or closing the doors and the draft registers. The primary chamber temperature can go as high as 800 to 1,200°F (427 to 649°C) when an auxiliary burner is used. However, many operators restrict the temperatures and amount of oxygen in order to increase yield.<sup>68</sup>

#### Emission Control Techniques

Most scrap metal incinerators use afterburners to complete the combustion of the exhaust gases, thereby controlling emissions of PM and gaseous organic compounds. These afterburners are typically fired with natural gas, and temperatures of 1,800 to 2,000°F (980 to 1,090°C) are achieved. Some scrap metal incinerators may be equipped with particulate collection devices such as fabric filters, but most have no additional controls other than the afterburner.<sup>68</sup>

#### Emission Factors

Emission factors were identified for a scrap metal incinerator that burns combustibles from scrap wire and drained transformer cores.<sup>68</sup> The scrap wire burned at the facility contains some PVC plastic insulation, and the drained transformer cores contain transformer oil residues containing less than 500 ppm of PCBs.

Temperatures in the primary chamber furnace during incineration were about 1,050°F (570°C). The facility is equipped with a natural gas-fired afterburner that achieves temperatures of 1,800 to 2,000°F (980 to 1,090°C).<sup>68</sup>

Emissions of TCDD/TCDF through OCDD/OCDF were measured in the stack after the afterburner. Table 4-28 presents emissions on a flue gas-concentration basis and as emission factors. Emission factors are based on the total weight of wire and transformer scrap feed to the furnace. The HpCDD/HpCDF and OCDD/OCDF were the primary species present, but measurable quantities of the TCDD/TCDF through HxCDD/HxCDF were also present.

#### 4.5.5 Drum and Barrel Reclamation Furnaces

Drum and barrel reclamation facilities recondition used steel drums for resale. Combustion is used to remove drum paints, interior linings, labels, residual liquids in the drum, and other contaminants. Residual materials include organic solvents, inks, paints, food, and a variety of other products.

##### Process Description

Figure 4-26 shows a flow diagram of a typical drum reclamation facility. Most facilities use a tunnel furnace to burn contaminants. The tunnel furnace is equipped with multiple natural gas burners on each side. Dirty drums are loaded onto a conveyor and conveyed to the furnace. Before entering the furnace, any free contents in the drums are drained into a collection vessel. The drums pass through the furnace, where temperatures reach about 1,000°F (540°C), and are air-cooled as they exit the furnace.<sup>69</sup> After cooling, the drums are shotblasted with an abrasive to clean the drum to bare metal. The drums are then repainted prior to sale.

TABLE 4-28. CDD/CDF FLUE GAS CONCENTRATIONS AND EMISSION FACTORS FOR A SCRAP WIRE AND TRANSFORMER INCINERATOR

SCC 3-04-900-13  
 FACTOR QUALITY RATING: D

Isomer	Flue Gas Concentration lb/ft <sup>3</sup> (μg/dscm) at 3% O <sub>2</sub> <sup>a</sup>	Emission Factor lb/ton (μg/kg) scrap feed
<b>DIOXINS</b>		
2,3,7,8-TCDD	7.86x10 <sup>-6</sup> (1.26x10 <sup>-1</sup> )	7.47x10 <sup>-10</sup> (3.74x10 <sup>-4</sup> )
Total Other TCDD	9.37x10 <sup>-5</sup> (1.50)	8.10x10 <sup>-9</sup> (4.05x10 <sup>-3</sup> )
Total PeCDD	3.22x10 <sup>-4</sup> (5.15)	2.74x10 <sup>-8</sup> (1.37x10 <sup>-2</sup> )
Total HxCDD	2.05x10 <sup>-3</sup> (32.8)	1.42x10 <sup>-7</sup> (7.11x10 <sup>-2</sup> )
Total HpCDD	1.04x10 <sup>-2</sup> (167)	6.94x10 <sup>-7</sup> (3.47x10 <sup>-1</sup> )
Total OCDD	3.11x10 <sup>-2</sup> (498)	2.00x10 <sup>-6</sup> (1.0)
Total CDD	4.40x10 <sup>-2</sup> (705)	2.88x10 <sup>-6</sup> (1.44)
<b>FURANS</b>		
2,3,7,8-TCDF	5.70x10 <sup>-5</sup> (9.13x10 <sup>-1</sup> )	5.34x10 <sup>-9</sup> (2.67x10 <sup>-3</sup> )
Total Other TCDF	2.80x10 <sup>-3</sup> (44.8)	2.08x10 <sup>-7</sup> (1.04x10 <sup>-1</sup> )
Total PeCDF	2.62x10 <sup>-3</sup> (42.0)	1.95x10 <sup>-7</sup> (9.74x10 <sup>-2</sup> )
Total HxCDF	5.92x10 <sup>-3</sup> (94.8)	4.06x10 <sup>-7</sup> (2.03x10 <sup>-1</sup> )
Total HpCDF	1.83x10 <sup>-2</sup> (293)	1.25x10 <sup>-6</sup> (6.23x10 <sup>-1</sup> )
Total OCDF	2.44x10 <sup>-2</sup> (390)	1.61x10 <sup>-6</sup> (8.07x10 <sup>-1</sup> )
Total CDF	5.41x10 <sup>-2</sup> (866)	3.68x10 <sup>-6</sup> (1.84)
<b>TOTAL CDD/CDF</b>	<b>9.81x10<sup>-2</sup> (1,571)</b>	<b>6.56x10<sup>-6</sup> (3.28)</b>

Source: Reference 68.

Note: The composition and combustible portion of the scrap metal was not stated in this report.

<sup>a</sup> Emissions measured in the stack gas after an afterburner.

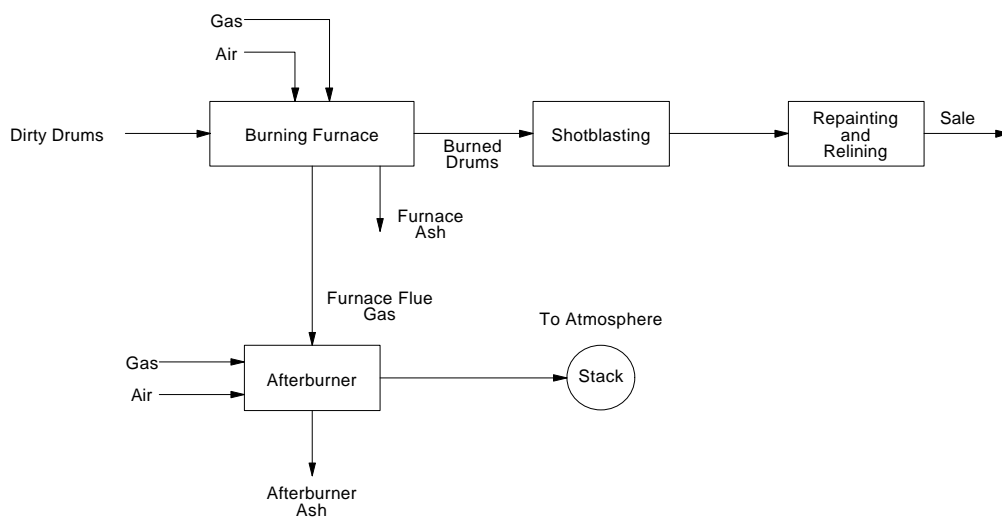

Figure 4-26. Drum and Barrel Incinerator Process Flow Diagram

Source: Reference 69.

## Emission Control Techniques

Natural gas-fired afterburners are typically used to combust unburned hydrocarbons in the exhaust gases from the furnace, thereby controlling emissions of gaseous organic compounds.

## Emission Factors

Emission factors were identified for a drum and barrel reclamation furnace that processes drums previously containing lacquer, organic solvents, inks, enamel-type paints and other materials.<sup>69</sup> The residue in the drums was analyzed for total organic halides (TOX). The TOX content of the residue in the drums during testing was about 800 ppm.

The facility is equipped with an afterburner. The afterburner operated at an average of 1,500°F (827°C) during testing. Emissions of TCDD/TCDF through OCDD/OCDF were measured both before and after the afterburner. Table 4-29 presents emissions on a flue gas-concentration basis and as emission factors. Emission factors are on a per-drum basis (55-gallon drum). These data show that the afterburner achieved greater than 95 percent control of CDD/CDF emissions.

## Source Locations

Approximately 2.8 to 6.4 million 55-gallon drums are reconditioned annually in the United States.<sup>47</sup> This estimate is based on the assumptions that there are 23 to 26 incinerators currently in operation, each incinerator handles 500 to 1,000 drums per day, and each incinerator operates 5 days a week with 14 days down time for maintenance.<sup>47</sup> Exact locations of the incinerators were not confirmed at the time this document was developed.

TABLE 4-29. CDD/CDF EMISSION CONCENTRATIONS AND EMISSION FACTORS FOR A DRUM AND BARREL RECLAMATION FACILITY

SCC 3-09-025-01  
 FACTOR QUALITY RATING: D

Isomer	<u>Before Afterburner</u>		<u>After Afterburner</u>	
	Flue Gas Concentration lb/ft <sup>3</sup> (μg/dscm) at 3% O <sub>2</sub>	Emission Factor lb/drum (μg/drum) <sup>a</sup>	Flue Gas Concentration lb/ft <sup>3</sup> (μg/dscm) at 3% O <sub>2</sub>	Emission Factor lb/drum (μg/drum) <sup>a</sup>
<b>DIOXINS</b>				
2,3,7,8-TCDD	1.024x10 <sup>-9</sup> (16.4)	4.61x10 <sup>-10</sup> (0.209)	3.22x10 <sup>-12</sup> (0.0516)	4.61x10 <sup>-12</sup> (2.09x10 <sup>-3</sup> )
Total Other TCDD	4.78x10 <sup>-9</sup> (76.6)	2.01x10 <sup>-9</sup> (0.912)	7.43x10 <sup>-11</sup> (1.19)	1.06x10 <sup>-10</sup> (0.0482)
Total PeCDD	6.49x10 <sup>-9</sup> (104)	2.69x10 <sup>-9</sup> (1.22)	4.49x10 <sup>-11</sup> (0.719)	6.44x10 <sup>-11</sup> (0.0292)
Total HxCDD	8.49x10 <sup>-9</sup> (136)	3.29x10 <sup>-9</sup> (1.49)	4.95x10 <sup>-11</sup> (0.793)	7.10x10 <sup>-11</sup> (0.0322)
Total HpCDD	1.66x10 <sup>-8</sup> (266)	8.11x10 <sup>-9</sup> (3.68)	8.18x10 <sup>-11</sup> (1.31)	1.18x10 <sup>-10</sup> (0.0534)
Total OCDD	5.43x10 <sup>-9</sup> (86.9)	2.78x10 <sup>-9</sup> (1.26)	5.74x10 <sup>-11</sup> (0.919)	8.27x10 <sup>-11</sup> (0.0375)
Total CDD	4.29x10 <sup>-8</sup> (687)	1.93x10 <sup>-8</sup> (8.78)	3.11x10 <sup>-10</sup> (4.98)	4.48x10 <sup>-10</sup> (0.203)
<b>FURANS</b>				
2,3,7,8-TCDF	3.90x10 <sup>-9</sup> (62.5)	1.67x10 <sup>-9</sup> (0.756)	5.60x10 <sup>-11</sup> (0.897)	8.05x10 <sup>-11</sup> (0.0365)
Total Other TCDF	5.81x10 <sup>-8</sup> (930)	2.38x10 <sup>-8</sup> (10.8)	8.93x10 <sup>-10</sup> (14.3)	1.29x10 <sup>-9</sup> (0.586)
Total PeCDF	3.89x10 <sup>-8</sup> (610)	1.62x10 <sup>-8</sup> (7.34)	3.87x10 <sup>-10</sup> (6.2)	5.58x10 <sup>-10</sup> (0.253)
Total HxCDF	1.46x10 <sup>-8</sup> (234)	5.67x10 <sup>-9</sup> (2.57)	1.87x10 <sup>-10</sup> (2.99)	2.69x10 <sup>-10</sup> (0.122)
Total HpCDF	1.60x10 <sup>-8</sup> (256)	7.74x10 <sup>-9</sup> (3.51)	1.26x10 <sup>-10</sup> (2.02)	1.81x10 <sup>-10</sup> (0.0822)
Total OCDF	4.61x10 <sup>-9</sup> (73.8)	2.31x10 <sup>-9</sup> (1.05)	3.43x10 <sup>-11</sup> (0.549)	4.94x10 <sup>-11</sup> (0.0224)
Total CDF	1.35x10 <sup>-7</sup> (2,170)	5.73x10 <sup>-8</sup> (26.0)	1.69x10 <sup>-9</sup> (27.0)	2.42x10 <sup>-9</sup> (1.10)
<b>TOTAL CDD/CDF</b>	<b>1.78x10<sup>-7</sup> (2,857)</b>	<b>7.67x10<sup>-8</sup> (34.8)</b>	<b>2.00x10<sup>-9</sup> (32.0)</b>	<b>2.87x10<sup>-9</sup> (1.3)</b>

Source: Reference 69.

Note: These emissions would originate from drums previously storing chlorine-containing lacquers, solvent, etc.

<sup>a</sup> Based on a 55-gallon drum.



## 4.6 PULP AND PAPER PRODUCTION - KRAFT RECOVERY BOILERS

Chemical wood pulping involves the extraction of cellulose from wood by dissolving the lignin that binds the cellulose together. Kraft pulping is the major form of chemical wood pulping in the United States, accounting for over 80 percent of the chemically produced pulp, and is expected to continue as the dominant pulp process.<sup>70,71</sup> The following sections focus on the pulp mill thermal chemical recovery processes associated with CDD/CDF emissions.

Black liquor is a digestion byproduct of the kraft pulping process that consists of soluble lignin and cooking chemicals. Concentrated black liquor is fired in a recovery furnace primarily to recover inorganic chemicals for reuse in the kraft process and, secondarily, to provide heat for process steam. Relative to other sources, particularly waste incineration, the combustion of black liquor has minimal potential for CDD/CDF emissions.<sup>72</sup>

### 4.6.1 Process Description

The kraft pulping process involves the cooking or digesting of wood chips at an elevated temperature 340 to 360°F (about 175°C) and pressure (100 to 135 psig) in "white liquor," which is a water solution of sodium sulfide ( $\text{Na}_2\text{S}$ ) and sodium hydroxide ( $\text{NaOH}$ ). The lignin that binds the cellulose fibers together is chemically dissolved by the white liquor in a digester. This process breaks the wood into soluble lignin and alkali-soluble hemicellulose and insoluble cellulose or pulp. A typical kraft sulfite pulping and recovery process is shown in Figure 4-27.

Two types of digester systems are used in chemical pulping: batch and continuous. In a batch digester, the contents of the digester are transferred to an atmospheric tank, usually referred to as a blow tank, after cooking is completed (2 to 6 hours). In a continuous digester, wood chips and white liquor continuously enter the system from the top while pulp is continuously withdrawn from the bottom into a blow tank. In both types of digesters, the entire

4-136

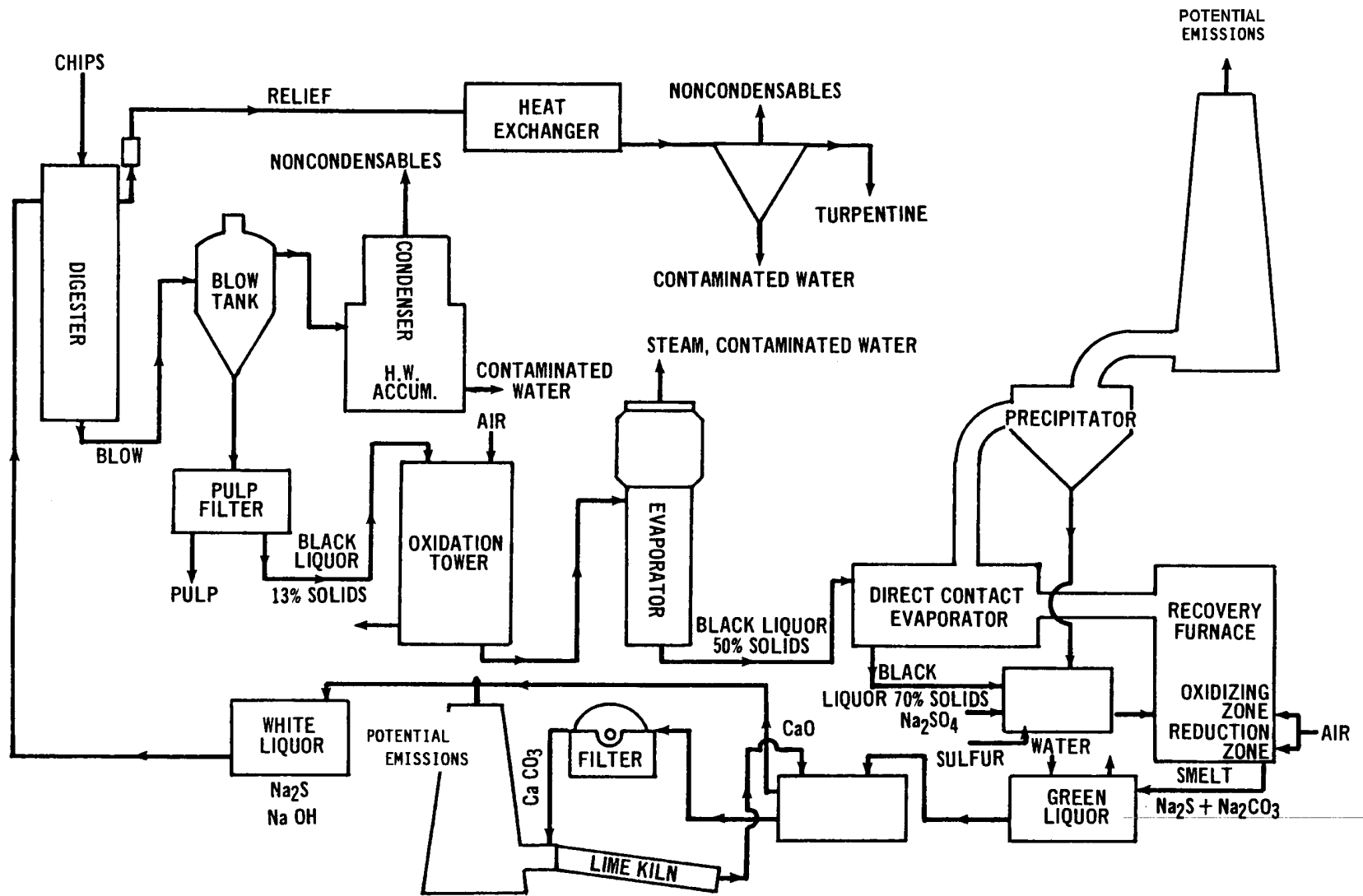

Figure 4-27. Typical Kraft Pulping and Recovery Process

Source: Reference 70.

contents of the blow tank are diluted and pumped to a series of brown-stock washers, where the spent cooking liquor (called black liquor) is separated from the pulp. The pulp, which may then be bleached, is pressed and dried into the finished product.

The balance of the kraft process is designed to recover the cooking chemicals and heat. The diluted spent cooking liquor, or weak black liquor, which is 12 to 18 percent dissolved solids, is extracted from the brownstock washers and concentrated in a multiple-effect evaporator system to about 55 percent solids. The liquor is then further concentrated to 65 percent solids (strong black liquor) in a direct contact evaporator (DCE) or a nondirect contact evaporator (NDCE), depending on the configuration of the recovery furnace in which the liquor is combusted. (DCE and NDCE recovery furnace schematics are shown in Figures 4-28 and 4-29, respectively.)

In older recovery furnaces, the furnace's hot combustion gases concentrate the black liquor in a DCE prior to combustion. NDCEs include most furnaces built since the early 1970s and modified older furnaces that have incorporated recovery systems that eliminate the conventional direct contact evaporators. These NDCEs use a concentrator rather than a DCE to concentrate the black liquor prior to combustion. In another type of NDCE system, the multiple effect evaporator system is extended to replace the direct contact system.

The strong black liquor is sprayed into a recovery furnace with air control to create both reducing and oxidizing zones within the furnace chamber. The combustion of the organics dissolved in the black liquor provides heat for generating process steam and, more importantly, reduces sodium sulfate to sodium sulfide to be reused in the cooking process. Sodium sulfate, which constitutes the bulk of the particulates in the furnace flue gas, may be recovered by an ESP and recycled. After combustion, most of the inorganic chemicals present in the black liquor collect as a molten smelt in the form of sodium carbonate ( $\text{Na}_2\text{CO}_3$ ) and sodium sulfide at the bottom of the furnace, where they are continuously withdrawn into a smelt-dissolving tank.

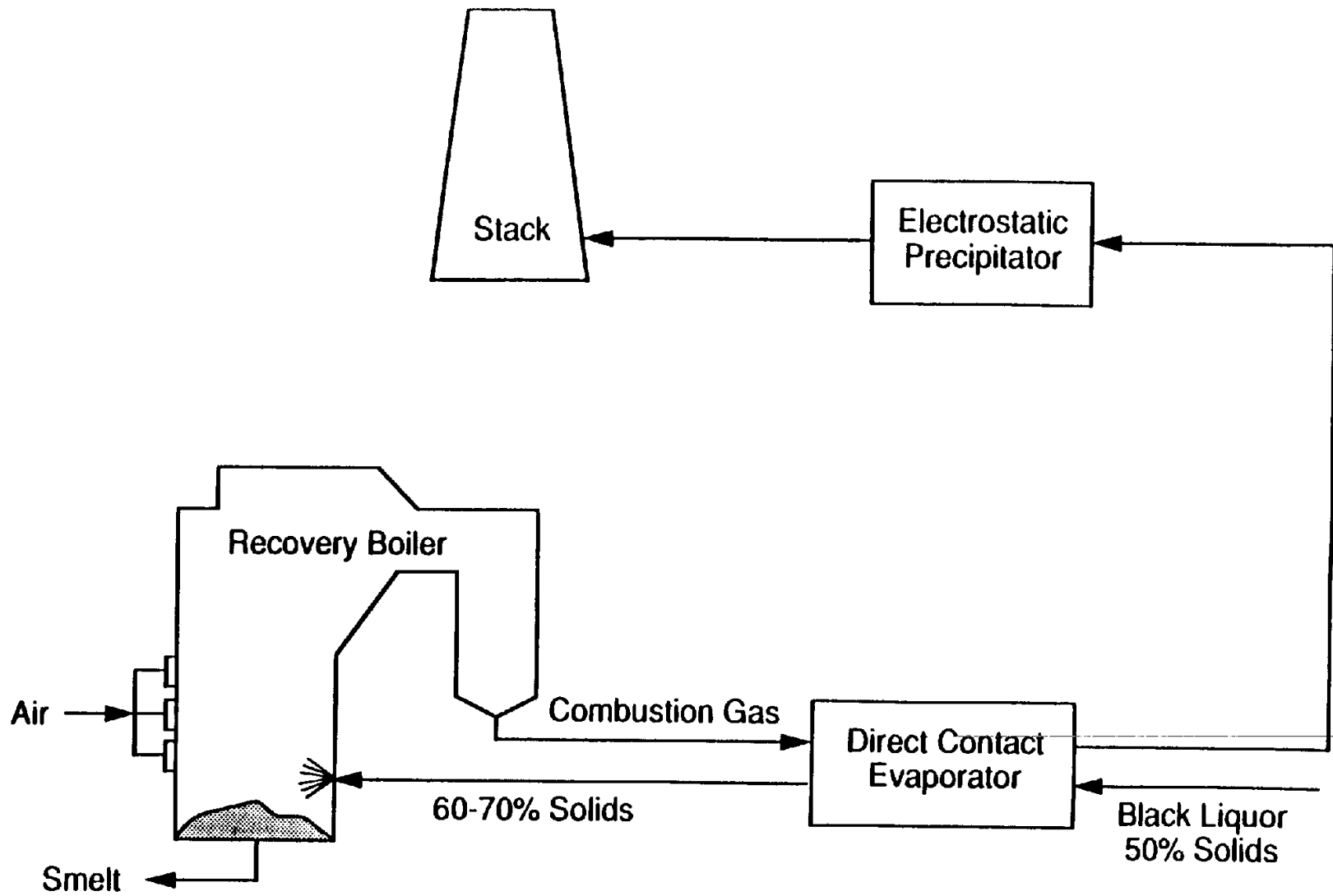

Figure 4-28. Direct Contact Evaporator Recovery Furnace

Source: Reference 70.

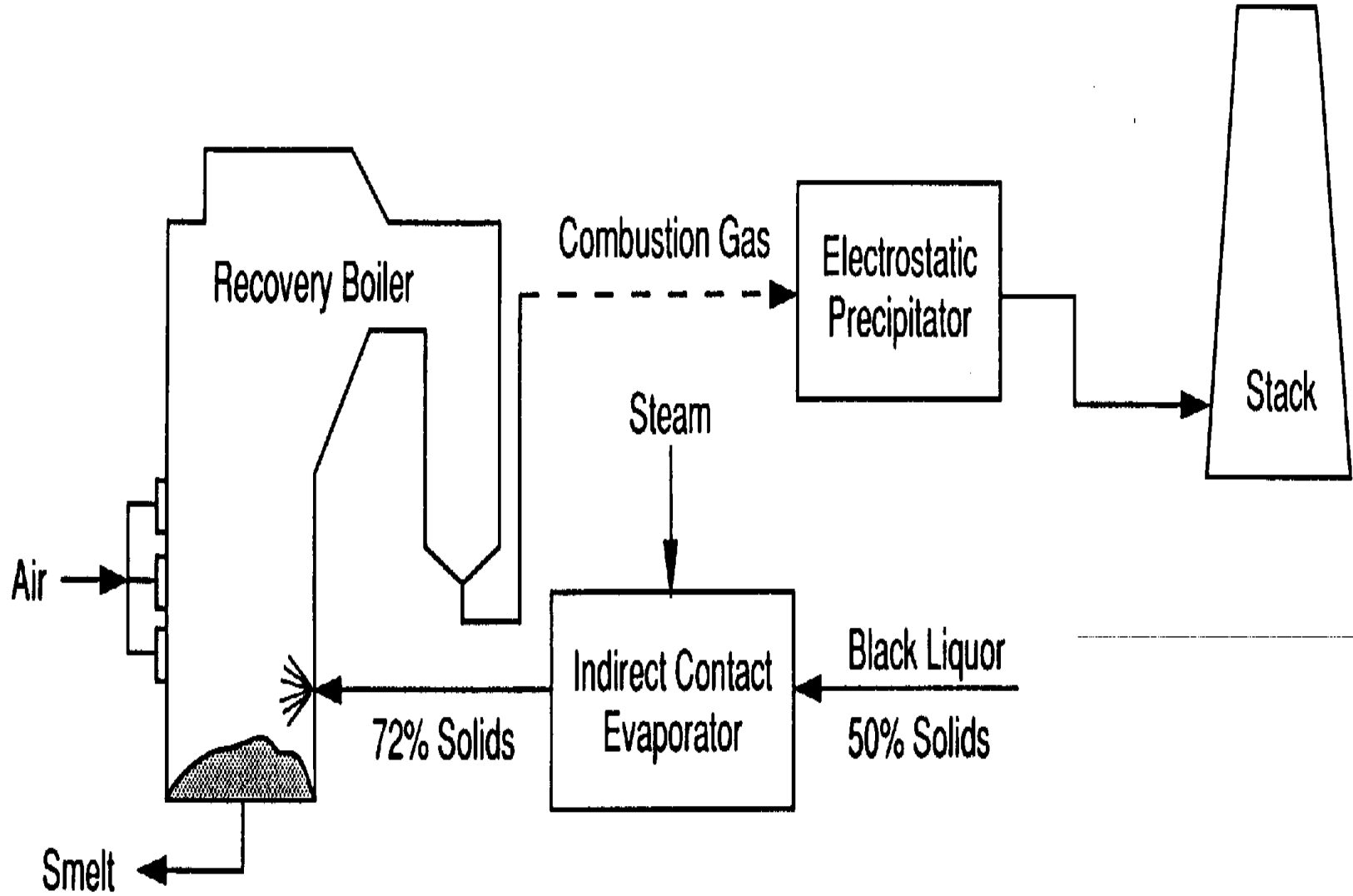

Figure 4-29. Nondirect Contact Evaporator Recovery Furnace

Source: Reference 70.

CDD/CDF emissions from black liquor combustion will be affected by furnace emission control devices as well as recovery process operating characteristics, furnace design and operation, and the characteristics of the black liquor feed. Furnace design and operation affect combustion efficiency, which is inversely related to CDD/CDF emissions. The black liquor recovery process determines the concentration of solids in the black liquor feed. Feeds containing a greater concentration of organic compounds will exhibit better combustion properties. Preliminary emissions test results from kraft recovery furnaces indicate that the CDD/CDF levels range from extremely low to nondetectable.<sup>9,41</sup>

Organic and inorganic chlorine inputs to the black liquor circuit increase the probability of CDD/CDF formation. The two primary sources of chlorine that enter the black liquor circuit are caustic makeup and mill water.<sup>72</sup>

In addition to straight kraft process liquor, semi-chemical pulping process spent liquor, known as brown liquor, may also be recovered in kraft recovery furnaces. The semi-chemical pulping process is a combination of chemical and mechanical pulping processes that was developed to produce high-yield chemical pulps. In the semi-chemical process, wood chips are partially digested with cooking chemicals to weaken the bonds between the lignin and the wood. Oversize particles are removed from the softened wood chips and the chips are mechanically reduced to pulp by grinding them in a refiner.

The most common type of semi-chemical pulping is referred to as neutral sulfite semi-chemical (NSSC). The major difference between the semi-chemical process and kraft/sulfite pulping process is that the semi-chemical digestion process is shorter and wood chips are only partially delignified. Based on a survey conducted by EPA in 1993 under the pulp and paper industry MACT standard development program, no U.S. semi-chemical mills currently practice chemical recovery. However, some semi-chemical pulp mills are, as of 1997, using chemical recovery.<sup>73</sup> Also, some mills combine spent liquor from on-site semi-chemical process with spent liquor from adjacent kraft process for chemical recovery.<sup>39</sup>

#### 4.6.2 Emission Control Techniques

Particulate emissions from the kraft recovery process are regulated by standards of performance in 40 CFR 60, Subpart BB. Particulate emissions consist primarily of sodium sulfate and sodium carbonate, with some sodium chloride and potentially trace quantities of CDD/CDF. Particulate control is provided on recovery furnaces in a variety of ways, which should have an effect on CDD/CDF emissions since CDD/CDF usually condense on particulate. Further particulate control is necessary for direct contact evaporators equipped with either a cyclonic scrubber or cascade evaporator because these devices are generally only 20 to 50 percent efficient for particulates.<sup>70</sup> Most often in these cases, an ESP is employed after the direct contact evaporator, for an overall particulate control efficiency range of 85 percent to more than 99 percent. At existing mills, auxiliary scrubbers may be added to supplement older and less efficient primary particulate control devices.

The most commonly used control device on NDCE recovery furnaces is an ESP. Both wet and dry bottom ESPs are in use within the industry. The control devices generally employ mechanisms to return captured particulate to the process, thus improving the efficiency of chemical recovery.

#### 4.6.3 Emission Factors

Emissions from kraft pulp and paper mills will vary with variations in the kraft pulping processes and the type of wood pulped.<sup>39</sup> The National Council of the Paper Industry for Air and Stream Improvement, Inc. (NCASI) recently evaluated and summarized CDD/CDF emissions data from seven mills burning black liquor. The individual test reports and site locations are considered confidential and were not made available for inclusion in this report. The information presented here was taken from NCASI's technical project summary. All TEFs provided in the summary and discussed in this section are based on the I-TEF/89 scheme, which

has been adopted by EPA as an interim procedure for assessing the risks associated with CDD/CDF exposure.

Detailed specific emissions data for CDD/CDF were reported for seven kraft recovery furnaces. The furnaces at five mills were NDCE furnaces, while the other two mills had direct contact furnaces. All seven furnaces were controlled with ESPs and two (one of each type) furnaces were followed by wet scrubbers (probably for added particulate emissions control).

The total CDD/CDF TEQs for all furnaces were small (<0.01 ng/dscm). One exception showed an average emission of about 1.6 ng TEQ/dscm at 8 percent O<sub>2</sub>. When subjected to various quality control criteria, the data from this test were found unacceptable and were discarded. For the remaining six furnaces tested, average emissions were estimated at about 0.002 ng TEQ/dscm at 8 percent O<sub>2</sub>. Assuming nominal conversion factors of 9,000 dscf/10<sup>6</sup> Btu, and 13,000 Btu/kg of black liquor solids (bls), an average emission factor of 1.1x10<sup>-5</sup> µg TEQ/kg bls is obtained.<sup>41</sup> Table 4-30 presents the summary of CDD/CDF emissions as reported by NCASI.

#### 4.6.4 Source Locations

The distribution of kraft pulp mills in the United States in 1997 is shown in Table 4-31. Kraft pulp mills are located primarily in the southeast, whose forests provide over 60 percent of U.S. pulpwood. Other areas of concentration include the Great Lakes region of the midwest and the Pacific northwest.

#### 4.7 ON-ROAD MOBILE SOURCES

Internal combustion engines can emit gas-phase polycyclic and polyhalogenated compounds (e.g., CDD and CDF) and organic PM as products of incomplete combustion. The combustion process variables specific to internal combustion engines are described in this section.



TABLE 4-30. SUMMARY OF TOTAL CDD/CDF EMISSIONS AND EMISSION FACTORS FROM  
KRAFT RECOVERY FURNACES

SCC 3-07-001-04, 3-07-001-10  
FACTOR QUALITY RATING: E

Unit ID	RFB4 <sup>a</sup>	RFC <sup>b</sup>	RFD <sup>c</sup>	RFED <sup>d</sup>	RFF <sup>e</sup>	RFG <sup>f</sup>	Average	Max	Min
I-TEF TEQ, lb/dscf (ng/dscm) at 8.0% O <sub>2</sub>	1.2x10 <sup>-16</sup> (2.0x10 <sup>-3</sup> )	1.5x10 <sup>-16</sup> (2.4x10 <sup>-3</sup> )	1.9x10 <sup>-16</sup> (3.0x10 <sup>-3</sup> )	9.9x10 <sup>-17</sup> (1.6x10 <sup>-3</sup> )	2.0x10 <sup>-16</sup> (3.3x10 <sup>-3</sup> )	1.3x10 <sup>-16</sup> (2.1x10 <sup>-3</sup> )	1.5x10 <sup>-16</sup> (2.1x10 <sup>-3</sup> )	2.0x10 <sup>-16</sup> (3.3x10 <sup>-3</sup> )	9.9x10 <sup>-17</sup> (1.6x10 <sup>-3</sup> )
Emission factor lb TEQ/ton (ug/kg) bls							2.2x10 <sup>-11</sup> (1.1x10 <sup>-5</sup> )		

Source: Reference 41.

Note: All results were reported at 12 percent CO<sub>2</sub>. Unit identification codes are confidential for the mills, boilers, and units tested.

<sup>a</sup> NDCE furnace with ESP and scrubber, 1990 tests in California - Scrubber Outlet.

<sup>b</sup> NDCE furnace with ESP, 1993 tests in Minnesota.

<sup>c</sup> NDCE furnace with ESP, 1992 tests in New York.

<sup>d</sup> DCE furnace with ESP and scrubber, 1992 tests in Louisiana - Scrubber Outlet.

<sup>e</sup> DCE furnace with wet bottom ESP, 1992 tests in North Carolina.

<sup>f</sup> NDCE furnace with ESP, 1990 tests in Michigan.

bls = Black liquor solids.

TABLE 4-31. DISTRIBUTION OF KRAFT PULP MILLS IN THE UNITED STATES (1997)

State	Kraft Pulp Mills	State	Kraft Pulp Mills
Alabama	14	Montana	1
Arizona	1	New Hampshire	1
Arkansas	7	New York	1
California	2	North Carolina	6
Florida	7	Ohio	1
Georgia	12	Oklahoma	1
Idaho	1	Oregon	7
Kentucky	2	Pennsylvania	3
Louisiana	10	South Carolina	6
Maine	7	Tennessee	2
Maryland	1	Texas	6
Michigan	3	Virginia	4
Minnesota	2	Washington	6
Mississippi	6	Wisconsin	4
		Total	124

Source: Reference 72.

#### 4.7.1 Process Description

Combustion generates the heat that takes place inside the combustion chamber. Internal combustion engines are generally fueled by gasoline, diesel fuel, or gasoline/oil mixtures, and can make use of either a two-stroke or a four-stroke cycle.

In a four-stroke cycle, the piston strokes are intake, compression, power, and exhaust. The two-stroke cycle gasoline engine is designed to eliminate the intake and exhaust strokes of the four-stroke cycle. The two-stroke cycle engine operates on a mixture of oil and gas, with the oil in the gas being the sole source of lubrication for the system.<sup>73</sup>

Most passenger cars and some trucks are gasoline-fueled, but large trucks, buses, and farm and heavy equipment are usually diesel-fueled. Motorcycles, outboard motors, lawn mowers, and chain saws are examples of equipment that typically use two-cycle engines.

Temperatures in the combustion chamber and exhaust system and volume flow rates influence CDD/CDF formation in internal combustion engines.<sup>11,74</sup> Gasoline engine combustion occurs at temperatures around 6,332°F (3,500°C) at near-stoichiometric oxygen levels. Gasoline engine exhaust temperatures generally range between 752 and 1,112°F (400 and 600°C). Diesel engines operate at combustion temperatures of about 3,657.6°F (2,000°C) with an excess of oxygen. Diesel engine exhaust temperatures range between 392 and 752°F (200 and 400°C).

The gasoline engine derives its power from the explosion of a mixture of air and gasoline, whereas in the diesel engine the fuel burns rather than explodes. The air-fuel mixture, when ignited, expands rapidly in a cylinder, forcing a piston from the top of the cylinder to the bottom. The exhaust gases from internal combustion engines are potential sources of CDD/CDF emissions.<sup>11</sup> After exhaust is released from a vehicle, it is diluted approximately 1,000-fold in the first few seconds and cools very rapidly.

Particulate emissions from diesels contain a significant amount of organic carbon. CDD/CDF may accumulate in engine oil and be emitted when the oil leaks into the combustion chamber or exhaust system and survives the emission process.<sup>11,76</sup>

A number of factors may affect CDD/CDF emissions from gasoline automobiles and trucks, including:<sup>11</sup>

- Air-to-fuel ratio;
- Mode of vehicle operation;
- Vehicle mileage;
- Fuel content;
- Presence of additives or lubricants; and
- Presence of emission controls.

Air-to-fuel ratios less than stoichiometric promote incomplete combustion and increase emissions. The effect of vehicle operation mode is related to the air-to-fuel ratio. Cold-start operation will cause higher emissions because the engine is operating in a fuel-rich condition. Higher engine load may also increase emissions during cold starts. Frequent engine start-ups and shut-downs will decrease the air-to-fuel ratio, thereby decreasing the amount of fuel oxidized.<sup>11</sup>

CDD/CDF emissions are expected to increase with vehicle mileage, primarily because of increased oil consumption. The higher quantities of oil consumed in older, more worn cylinders provide more intermediates for CDD/CDF formation; in addition, the CDD/CDF become concentrated in the oil.<sup>76</sup> Another cause of increased CDD/CDF emissions with increased mileage is the formation of deposits in the combustion chamber. Emissions increase with mileage until the deposits become stabilized.

Several studies have identified strong correlations between chlorinated additives in gasoline and motor oil and CDD/CDF emissions during combustion tests.<sup>8,75,76</sup> Unleaded gasoline may have a chlorine content of approximately 0.2 lb/ton (10 ppm), whereas the chlorine content in leaded gasoline may be 5 to 10 times higher.<sup>77</sup> In addition, it has been suggested that the concentration of aromatics in the fuel may contribute to these emissions.

CDD/CDF emissions are higher in cars using leaded gasoline.<sup>76</sup> One reason may be that leaded gasoline contains chlorine in the form of dichloroethane, which is added as a "lead scavenger." However, the amount of lead in leaded gasoline has decreased, and leaded gasoline was totally phased out in 1996.

#### 4.7.2 Emission Control Techniques

Emission control devices such as catalytic converters have reduced automobile emissions significantly since the early 1970s.<sup>76</sup> In one study, no dioxins were detected in cars

equipped with catalytic converters using unleaded gasoline.<sup>76</sup> A subsequent study revealed some CDD and CDF in catalyst-equipped cars, but at much lower levels than in the cars using leaded gasoline.<sup>77</sup> It is theoretically possible that the CDD/CDF formed in cars using unleaded gasoline could be destroyed in the catalytic converter.<sup>76</sup> However, the lower levels of CDD/CDF found in cars equipped with catalytic converters using unleaded gasoline cannot be attributed solely to the catalytic converter. It appears the combination of the unleaded gasoline and the catalytic converter lowers CDD/CDF levels.

#### 4.7.3 Emission Factors

CDD/CDF can be formed from mobile sources. However, emission factors relevant to the United States are not readily available. A low confidence or quality rating is assigned to the results and emission factors derived from European studies because the fuels and control technologies used in these cars most likely differ from U.S. fuels and technologies.

In a 1987 study in Sweden, automobile exhaust emissions were analyzed for CDD/CDF.<sup>4</sup> No CDD/CDF were identified from cars equipped with catalytic converters using unleaded gasoline (representative of cars in the United States). The reported results from cars without catalytic converters and burning leaded gasoline is not representative of cars in the United States because the normal scavenger mixture of dichloro- and dibromoethane were not used. Reported CDD/CDF emissions were approximately  $2.6 \times 10^{-8}$  to  $4.7 \times 10^{-7}$  lb/ton (13 to 235 ng/kg) or  $8.6 \times 10^{-11}$  to  $1.6 \times 10^{-9}$  lb/gal (39 to 704 ng/gal) of gasoline burned.

A 1991 Norwegian study reported CDD/CDF emission factors for on-road vehicles measured in a tunnel experiment. The length of the tunnel was not specified in the report, but since complex ventilation was not stated, the length was probably relatively short. Measurements of traffic density, traffic composition, and ventilation rate were also performed. Most of the emissions were observed up a grade and were not measured on a flat road. Road tunnel studies can represent an opportunity to obtain exhaust emission factors which can be

representative for the car population and the various traffic conditions that usually prevail in a tunnel.

The data presented in Table 4-32 differentiates between emission factors for light duty (LDV) and heavy duty diesel vehicles (HDDV). Although weekday and weekend sampling occurred, the study did not differentiate between the fraction of light- and heavy-duty fleets sampled during this period. Depending upon driving conditions, the estimated emission factors were in the order of  $1.4 \times 10^{-13}$  to  $1.8 \times 10^{-12}$  lb/mile (0.04 to 0.5 ng/km) 2,3,7,8-TEQ (Nordic Model) for LDV and  $2.5 \times 10^{-10}$  to  $3.4 \times 10^{-11}$  lb/mile (0.7 to 9.5 ng/km) for HDDV. The emission factors for LDV, expressed as ng/km 2,3,7,8-TEQ, were obtained by dynamometer experiments using leaded gasoline with dichloroethane added as a scavenger, which is not representative of on-road motor vehicles in the United States.

The reader is cautioned in using the emission factors presented in Table 4-32 and should recognize that this experiment was conducted with a mixture of new and old cars (which are not always properly maintained). At the time of the measurements, the average age of the car was about 9 years, and unleaded gasoline usage was only 25 to 30 percent of total consumption, which also is not representative of on-road vehicles in the United States.

#### 4.7.4 Source Locations

Internal combustion engines can be found in numerous vehicles, including passenger cars, small and large trucks, buses, motorcycles, trains, ships, aircraft, farm machinery, and military vehicles. Because these vehicles can be found nationwide, attempting to list specific source/sites is not feasible. It may be reasonable to assume, however, that there is a direct

TABLE 4-32. EMISSION FACTORS FOR ON-ROAD MOBILE SOURCES  
AMS 22-01-001-000  
FACTOR QUALITY RATING: U

Source	2,3,7,8-TCDD TEQ <sup>a</sup> lb/VMT (ng/VkmT)	2,3,7,8-TCDD lb/VMT (ng/VkmT)	2,3,7,8-TCDF lb/VMT (ng/VkmT)
Light Duty Vehicles	$1.35 \times 10^{-13}$ - $1.84 \times 10^{-12}$ ( $3.80 \times 10^{-2}$ - $5.20 \times 10^{-1}$ )	---	---
Heavy Duty Diesel Vehicles	$2.55 \times 10^{-12}$ - $3.37 \times 10^{-11}$ ( $7.20 \times 10^{-1}$ - 9.5)	---	---
Total on-road vehicles <sup>b</sup>	$8.85 \times 10^{-14}$ ( $2.50 \times 10^{-2}$ )	$3.6 \times 10^{-15}$ ( $1.00 \times 10^{-3}$ )	$5.65 \times 10^{-14}$ ( $1.60 \times 10^{-2}$ )

<sup>a</sup> Source: Reference 78.

<sup>b</sup> Source: Reference 79.

VMT = vehicle miles travelled.

correlation between population density and the number of mobile vehicles in an area (i.e., there would be more vehicles in a densely populated area than in a rural area).

#### 4.8 CARBON REGENERATION

Activated carbon is used primarily for adsorbing pollutants from water or air (e.g., in industrial or municipal wastewater treatment plants). Because of increasing environmental awareness and tighter regulations, the demand for activated carbon is increasing. The consumption of activated carbon in water and wastewater treatment operations in 1990 was reported at  $1.44 \times 10^8$  lb (71,900 tons) ( $6.54 \times 10^7$  kg).<sup>80</sup>

Used carbon can be regenerated (reactivated) by essentially the same process as used for the original activation. The regeneration process creates the potential for CDD/CDF formation.

#### 4.8.1 Process Description

In the regeneration process, organics adsorbed on carbon during use are burned off by placing the spent carbon in continuous internally or externally fired rotary retorts or, most commonly, in multiple-hearth furnaces.<sup>81</sup> Figure 4-30 shows a cross-section of a typical multiple-hearth furnace. In this type of furnace, the charge (carbon) is stirred and moved from one hearth to the next lower hearth by rotating rabble arms. For smaller-scale regeneration operations, fluidized-bed and infrared furnaces can be used. The various furnace types used for carbon regeneration and the approximate number of furnaces of each type are shown in Table 4-33.<sup>82</sup>

In a typical regeneration process, spent carbon in a water slurry form is fed from a surge tank to a dewatering screw, which feeds the spent carbon to the top of the furnace. In the furnace, the spent carbon is dried and the organics on the carbon are volatilized and burned as the carbon is regenerated. The regenerated carbon drops from the bottom hearth of the furnace to a quench tank and is stored as a slurry.<sup>81</sup> A flow diagram of the carbon regeneration process is shown in Figure 4-31.<sup>81</sup>

A hot gas, such as steam or carbon dioxide, is introduced into the furnace at temperatures of approximately 1498 to 1858°F (800 to 1,000°C), although some excess oxygen is typically present throughout the furnace.<sup>83</sup> The regeneration process is exothermic, using the heating value of the volatile carbon plus heat supplied from supplemental fuel (e.g., natural gas). A typical furnace may fire an average of 459,089 cubic feet (13,000 cubic meters/day) of natural gas.<sup>81</sup>

Typical industrial carbon regeneration plants may process up to 109,127 lbs/day (49,500 kg/day) of spent carbon from numerous industrial or municipal facilities that use activated carbon for wastewater treatment.<sup>81</sup> Regeneration plants may operate 24 hrs/day, 7 days/wk for much of the year, with periodic shut-downs for furnace maintenance.



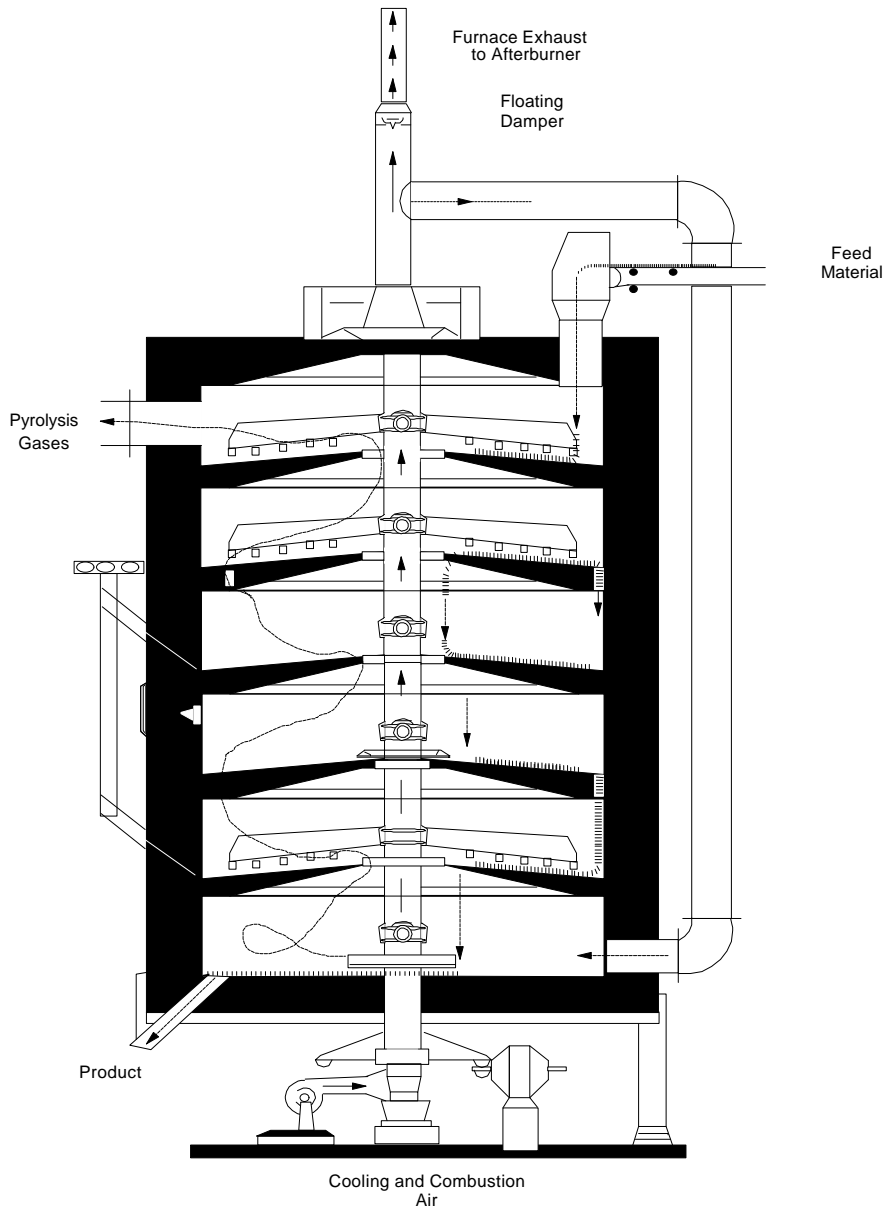

Figure 4-30. Cross Section of a Typical Multiple-Hearth Furnace

Source: Reference 18.

TABLE 4-33. TYPES OF EQUIPMENT USED FOR ACTIVATED  
CARBON REGENERATION

Furnace Type	Approximate No. of Units in U.S.
Multiple-hearth	<100
Fluidized-bed	<20
Indirect-fired rotary kiln	>50
Direct-fired rotary kiln	<30
Vertical-tube type	<30
Infrared-horizontal	<5
Infrared-vertical	4

Source: Reference 82.

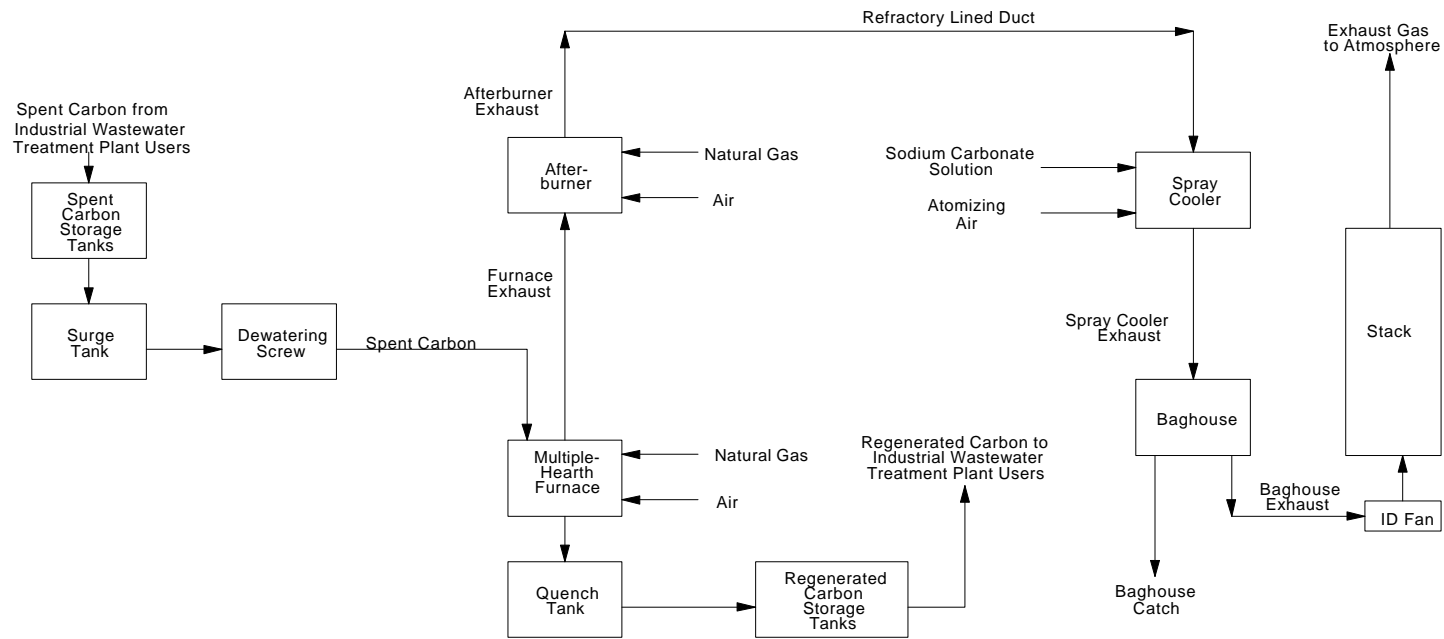

Figure 4-31. Process Flow Diagram of a Carbon Regeneration Process

Source: Reference 82.

Emissions from carbon activation and regeneration processes contain a number of toxic air pollutants. Regeneration has an even greater potential for producing toxic emissions because the carbon has often been used in adsorbing compounds classified as toxic air pollutants.<sup>83</sup>

Of special interest is the potential for CDD/CDF formation in the high-temperature, low-oxygen environment of the regeneration furnace. One study found no evidence of CDD/CDF emissions from the regeneration of virgin carbon, but did detect both families of compounds when regenerating spent carbon from wastewater treatment facilities.<sup>84</sup> The data indicate that these byproducts formed from the adsorbed organics on the spent carbon rather than from impurities in the virgin carbon.

#### 4.8.2 Emission Control Techniques

The primary point source of emissions from the carbon regeneration process is the furnace exhaust. These emissions are typically controlled by afterburners followed by water scrubbers.<sup>81</sup> The afterburner may consist of a short vertical section with natural gas-fired burners and a long horizontal section of refractory-lined duct with no burners. Afterburner combustion temperatures of 1822°F (980°C) or greater and residence times in excess of two seconds are typical.<sup>83</sup> Temperatures greater than 1625°F (871°C) and residence times longer than 0.5 seconds are recommended.<sup>81</sup> There are no available data on destruction removal efficiency (DRE) for an afterburner control system in this application. However, the conditions and configuration are similar to those used for controlling hazardous waste incinerator emissions, where DREs of 99.99 percent are typical.<sup>83</sup>

Exhaust gases from the afterburner can be cooled by an alkaline (e.g., sodium carbonate) spray cooler in which an atomized dilute alkaline solution is mixed with the exhaust gas. The alkaline medium neutralizes acid gases to permit compliance with regulatory emission limits.<sup>83</sup> From the spray cooler, the exhaust gases may enter centrifugal or fabric filter (baghouse)

collectors, which are used to control particulate and reaction products from upstream components. Collection efficiencies of 65 percent for centrifugal collection and 99 percent for fabric filtration have been reported.<sup>83</sup> The collected particulate is ultimately disposed of in a landfill.

#### 4.8.3 Emissions and Emission Factors

Several studies have been conducted to test CDD/CDF emissions from carbon regeneration facilities. Table 4-34 summarizes the results of two studies in which emissions from a fluidized-bed system were tested.<sup>9</sup> The first study tested emissions from the system before an afterburner was installed; the second study took place after its installation. The carbon regenerated during the first study had been in service for approximately one year, and the carbon in the second study for 200 days.

In the first study, concentrations of 2,3,7,8-TCDD in the flue gas ranged from  $6.24 \times 10^{-16}$  to  $1.31 \times 10^{-14}$  lb/ft<sup>3</sup> (0.01 to 0.21 ng/m<sup>3</sup>), with an average of  $6.24 \times 10^{-15}$  lb/ft<sup>3</sup> (0.1 ng/m<sup>3</sup>). In the second study, emissions from the stack and afterburner were tested. 2,3,7,8-TCDD was not detected in any of the samples.

In another study, a horizontal infrared regeneration furnace was fitted with an afterburner designed to provide a 20-second residence time at a temperature of 1876°F (1010°C). Table 4-35 shows CDD/CDF emissions from this study.<sup>84</sup>

Results of CDD/CDF emissions testing at a carbon regeneration facility with a multiple-hearth furnace are shown in Table 4-36.<sup>81</sup> The emissions at this facility were controlled by an afterburner, a sodium carbonate spray cooler, and a baghouse. Sampling was performed at the spray cooler inlet location and the baghouse outlet exhaust stack. Samples of the baghouse

TABLE 4-34. CDD/CDF CONCENTRATIONS IN THE FLUE GAS AND ASH FROM A FLUIDIZED-BED CARBON REGENERATION FURNACE

Type of Facility	Sample	2,3,7,8-TCDD		Total CDD		Total CDF	
		Mean in lb/ft <sup>3</sup> (ng/m <sup>3</sup> )	Range in lb/ft <sup>3</sup> (ng/m <sup>3</sup> )	Mean in lb/ft <sup>3</sup> (ng/m <sup>3</sup> )	Range in lb/ft <sup>3</sup> (ng/m <sup>3</sup> )	Mean in lb/ft <sup>3</sup> (ng/m <sup>3</sup> )	Range in lb/ft <sup>3</sup> (ng/m <sup>3</sup> )
Fluidized-Bed w/o Afterburner	FG	6.2x10 <sup>-15</sup> (0.1)	0.62 - 13.11x10 <sup>-15</sup> (0.01 - 0.21)	11.2x10 <sup>-15</sup> (0.18)	3.75 - 18.7x10 <sup>-15</sup> (0.06 - 0.3)	18.7x10 <sup>-15</sup> (0.3)	5.0 - 31.8x10 <sup>-15</sup> (0.08 - 0.51)
	PM	50x10 <sup>-6</sup> lb/ton (25 ng/g)	8.6 - 102.4x10 <sup>-6</sup> lb/ton (4.3 - 51.2 ng/g)	96x10 <sup>-6</sup> lb/ton (48 ng/g)	72-132x10 <sup>-6</sup> lb/ton (36 - 66 ng/g)	206x10 <sup>-6</sup> lb/ton (103 ng/g)	ND - 490x10 <sup>-6</sup> lb/ton (ND - 245 ng/g)
Fluidized Bed w/Afterburner	FG (Stack)	ND		98.7x10 <sup>-15</sup> (1.58) <sup>a</sup>		3.1x10 <sup>-15</sup> (0.05) <sup>b</sup>	
	FG (Recup)	ND		99.3x10 <sup>-15</sup> (1.59)	ND - 2.32x10 <sup>-13</sup> (ND - 3.71)	85.5x10 <sup>-13</sup> (1.37)	0.94 - 297.2x10 <sup>-15</sup> (0.015 - 4.76)
	FG (Afterburner 1 sec.)	ND		7.5x10 <sup>-15</sup> (0.12)		27.5x10 <sup>-15</sup> (0.44)	
	FG (Afterburner 2 sec.)	ND		43.7x10 <sup>-14</sup> (0.7)	ND - 8.74x10 <sup>-14</sup> (ND - 1.4)	1.81x10 <sup>-14</sup> (0.29)	11.8 - 24.4x10 <sup>-15</sup> (0.19 - 0.39)

Source: Reference 9.

<sup>a</sup> HpCDD and OCDD homologues only.

<sup>b</sup> HxCDF, HpCDF, OCDF homologues only.

FG = Flue gas.

PM = Particulate matter.

ND = Not detected.

TABLE 4-35. CDD/CDF CONCENTRATIONS AND EMISSION FACTORS FOR A  
HORIZONTAL INFRARED CARBON REGENERATION FURNACE<sup>a,b</sup>  
SCC 3-99-999-93  
FACTOR QUALITY RATING: U

Isomer	Average Concentration in lb/dscf (ng/dscm)	Emission Factors in lb/ton (mg/kg) of carbon regenerated
<b>DIOXINS</b>		
2,3,7,8-TCDD	ND	
Total Other TCDD	7.50x10 <sup>-14</sup> (1.20x10 <sup>-2</sup> )	4.80x10 <sup>-5</sup> (2.40x10 <sup>-2</sup> )
Total PeCDD	ND	--
Total HxCDD	2.80x10 <sup>-16</sup> (4.48x10 <sup>-1</sup> )	1.80x10 <sup>-3</sup> (9.00x10 <sup>-1</sup> )
Total HpCDD	2.00x10 <sup>-15</sup> (3.20x10 <sup>-2</sup> )	1.20x10 <sup>-4</sup> (6.40x10 <sup>-2</sup> )
Total OCDD	1.56x10 <sup>-16</sup> (2.50x10 <sup>-1</sup> )	1.28x10 <sup>-4</sup> (5.02x10 <sup>-1</sup> )
Total CDD	7.74x10 <sup>-14</sup> (7.42x10 <sup>-1</sup> )	2.10x10 <sup>-3</sup> (1.49)
<b>FURANS</b>		
2,3,7,8-TCDF	4.20x10 <sup>-15</sup> (6.80x10 <sup>-2</sup> )	2.74x10 <sup>-4</sup> (1.37x10 <sup>-1</sup> )
Total Other TCDF	1.18x10 <sup>-16</sup> (1.89x10 <sup>-1</sup> )	7.60x10 <sup>-4</sup> (3.80x10 <sup>-1</sup> )
Total PeCDF	4.70x10 <sup>-15</sup> (7.50x10 <sup>-2</sup> )	3.02x10 <sup>-4</sup> (1.51x10 <sup>-1</sup> )
Total HxCDF	1.87x10 <sup>-15</sup> (3.00x10 <sup>-2</sup> )	1.20x10 <sup>-4</sup> (6.00x10 <sup>-2</sup> )
Total HpCDF	2.68x10 <sup>-15</sup> (4.30x10 <sup>-2</sup> )	1.72x10 <sup>-4</sup> (8.60x10 <sup>-2</sup> )
Total OCDF	2.06x10 <sup>-15</sup> (3.30x10 <sup>-2</sup> )	1.32x10 <sup>-4</sup> (6.60x10 <sup>-2</sup> )
Total CDF	1.56x10 <sup>-14</sup> (4.38x10 <sup>-1</sup> )	1.76x10 <sup>-3</sup> (8.8x10 <sup>-1</sup> )

Source: Reference 84.

<sup>a</sup> Combustion gas flow rate was 196 dscm/hr. Facility operated 7,000 hr/yr. Operating rate of system was 97.5 kg of spent activated carbon per hour.

<sup>b</sup> Control device consists of afterburner sized for a 0.3-minute (20-second) residence time at 1,850°F (1,010°C).

ND = Not detected.

U = Unratable.

TABLE 4-36. CDD/CDF EMISSIONS DATA FROM A MULTIPLE-HEARTH CARBON  
 REGENERATION FURNACE<sup>a</sup>  
 SCC 3-99-999-93  
 FACTOR QUALITY RATING: D

Isomer	Concentration in lb/dscf (ng/dscm)	Emission Factor in lb/ton (ng/kg)
INLET:		
2,3,7,8-TCDD	5.62x10 <sup>-15</sup> (9.00x10 <sup>-2</sup> )	1.78x10 <sup>-9</sup> (8.90x10 <sup>-1</sup> )
Total CDD	1.79x10 <sup>-18</sup> (28.8)	6.00x10 <sup>-11</sup> (300)
Total CDF	3.13x10 <sup>-18</sup> (50.1)	1.40x10 <sup>-12</sup> (700)
OUTLET:		
2,3,7,8-TCDD	ND	ND
Total CDD	2.30x10 <sup>-17</sup> (3.69)	6.26x10 <sup>-10</sup> (31.3)
Total CDF	2.07x10 <sup>-17</sup> (3.32)	5.46x10 <sup>-10</sup> (27.3)
BAGHOUSE ASH:		
Total CDD	6.86x10 <sup>-16</sup> (1.1)	NR
Total CDF	3.12x10 <sup>-16</sup> (5.00x10 <sup>-1</sup> )	NR

Source: Reference 81.

<sup>a</sup> Control devices consist of afterburner, sodium carbonate spray cooler, and baghouse.

ND = Not detected.

NR = Not reported.



dust were also collected and analyzed for CDD/CDF. In addition, ambient air sampling was performed near the atomizing air intake point at the spray cooler.

Detectable quantities of all targeted dioxin and furan species except 2,3,7,8-TCDD and 2,3,7,8-TCDF were found in the stack gas at the baghouse outlet exhaust stack. At the spray cooler inlet, all targeted CDD/CDF species were detected. Dioxin and furan homologues except 2,3,7,8-TCDD were detected at low concentrations in the baghouse ash.

Results of 1991 emissions tests performed at a county water treatment facility in California were recently made available. The tests were conducted on the lime recalcining unit and the charcoal furnace. Each unit was tested for speciated organic compounds, including dioxins and furans. Emission factors developed from the test results are presented in Table 4-37. Note that the configuration and type of furnace tested is not known. However, the test report did state that the furnace was controlled by an afterburner and a scrubber.<sup>85</sup>

TABLE 4-37. CARBON REGENERATION FURNACE EMISSION FACTORS  
 SCC 3-99-999-93  
 FACTOR QUALITY RATING: U

Pollutant	Emission Factor	
	lb/ton carbon reactivated	Kg/Mg carbon reactivated
2,3,7,8-TCDD	2.10x10 <sup>-10</sup>	1.05x10 <sup>-10</sup>
2,3,7,8-TCDF	1.36x10 <sup>-9</sup>	6.80x10 <sup>-10</sup>
2,3,7,8-TCDD TEQ	3.46x10 <sup>-9</sup>	1.73x10 <sup>-9</sup>
Total CDD	4.64x10 <sup>-8</sup>	2.32x10 <sup>-8</sup>
Total CDF	4.76x10 <sup>-8</sup>	2.38x10 <sup>-8</sup>

Source: Reference 85. The type of configuration of the furnace were not specified. Control devices used were an afterburner and a scrubber.

In summary, the studies indicated that, in most cases, detectable quantities of targeted dioxin and furan species were found at various locations (stack outlets, spray cooler inlets, ambient air) at carbon regeneration facilities. However, emission control devices reduced CDD/CDF emissions. The sites chosen for these studies were considered representative of other carbon regeneration facilities in the United States; therefore, the emission factors developed from the data are considered reliable.

#### 4.8.4 Source Locations

Activated carbon is used primarily to adsorb organics from water at industrial or municipal wastewater treatment plants. Carbon regeneration may be performed at the site where the carbon was used (on-site regeneration) or at a commercial regeneration facility that processes spent carbon from multiple industries. Because of the numbers of potential individual emission sources, listing specific sites in this document is not feasible.

### 4.9 OPEN BURNING AND ACCIDENTAL FIRES

This section describes CDD/CDF formation from forest fires, agricultural and open refuse burning, and structure (building) and PCB fires, and their associated emission factors.

#### 4.9.1 Forest Fires and Agricultural Burning

##### Process Description

The burning of forest lands occurs through controlled prescribed burning and through uncontrolled accidental forest fires. Prescribed burning is the application and confinement of fire under specified weather, fuel moisture, and soil moisture conditions to accomplish planned benefits such as fire hazard reduction, control of undesired species, seedbed and site preparation, wildlife habitat improvement, and tree disease control. Uncontrolled forest

fires (wildfires) are fires that are started naturally (e.g., by lightning), accidentally, or intentionally that burn and spread in generally unpredictable patterns.

Agricultural burning involves the purposeful combustion of field crop, row crop, and fruit and nut crop residues to achieve one or a combination of desired objectives. The typical objectives of agricultural burning are:

- Removal and disposal of agricultural residue at a low cost;
- Preparation of farmlands for cultivation;
- Cleaning of vines and leaves from fields to facilitate harvest operations;
- Disease control;
- Direct weed control by incinerating weed plants and seeds;
- Indirect weed control by providing clean soil surface for soil-active herbicides; and
- Selective destruction of mites, insects, and rodents.

The types of agricultural waste subject to burning include residues such as rice straw and stubble, barley straw and stubble, wheat residues, orchard prunings and natural attrition losses, grass straw and stubble, potato and peanut vines, tobacco stalks, soybean residues, hay residues, sugarcane leaves and tops, and farmland grass and weeds.

#### Emission Factors

Although the potential for emissions exists, CDD/CDF emission factors have not been identified for agricultural burning. As discussed above, CDD/CDF have been detected in wood-fired boiler emissions and in the ash from residential wood stoves. Although the combustion processes that take place in agricultural burning are different from those in wood-fired boilers or wood stoves, the fuels are of similar composition. Reported chloride

concentrations range from 100 to 10,000 ppm in wood and agricultural vegetative matter.<sup>86</sup> Emission factors based on the mass of pollutant emitted per mass of material combusted would be expected to be low for agricultural burning; however, total emissions could be substantial because of the large amounts of materials combusted.

Two separate studies reviewed indicated that wood burned in forest fires may reasonably be considered a source of CDD/CDF.<sup>87,88</sup> Another study reviewed reported direct measurements of CDD/CDF in the actual emissions from forest fires at detected levels of 15 to 400 pg/m<sup>3</sup> for total CDD/CDF.<sup>89</sup> These concentrations cannot accurately be converted to an emission factor because the rate of wood combustion is not known. However, an alternative approach assumes that the emission factor for residential wood burning (using natural wood and an open door) applies to forest fires. This approach suggests an emission factor of about 1 ng TEQ/kg of material burned for total CDD/CDF. It should be noted that forest fire and wood stove combustion conditions differ significantly. Thus, this emission factor is considered highly uncertain and is assigned a low quality rating of U (unratable because it was developed from engineering judgment based on theoretical data).

#### Source Locations

According to the U.S. Forest Service, the majority of prescribed burning in the United States occurs in the southern/southeastern region of the United States (60 percent in 1984), followed by the Pacific Northwest (almost 20 percent), and California (10 percent).<sup>87,88</sup>

The locations of uncontrolled forest fires are not as definable as those of prescribed burning sites, but historical records of fires and a knowledge of the locations of primary forest resources can be used to predict where the majority of forest fires are likely to occur. The southern and western regions of the country (including California, the Pacific Northwest, and western mountain states) appear to represent the greatest potential for forest wildfires. Forest Service data for 1983 indicate that 67 percent of the total number of acres

burned by wildfires nationally were in the southern/southeastern region. The western regions contained 17 percent of the wildfire-burned acreage, and the northern region (Idaho, Montana, North Dakota) contained another 6 percent.

Agricultural burning is directly tied to the agriculture industry. Major agricultural states--including California, Louisiana, Florida, Hawaii, North Carolina, Mississippi, and Kansas--conduct the majority of agricultural burning.

#### 4.9.2 Miscellaneous Open Refuse Burning and Structure Fires

##### Process Description

The most readily identifiable types of open-burned refuse materials are municipal refuse, bulky items such as furniture and bedding, construction debris, and yard waste. Structure fires are similar to open refuse burning in that the types of materials combusted are similar (e.g., wood, paper, plastic, textiles, etc.).

The procedure of open burning is relatively simple. The material to be burned is collected and aggregated in an open space fully exposed to the atmosphere. The materials are ignited and allowed to burn and smolder until all combustible material is consumed or the desired degree of volume reduction is achieved. Structure fires are highly variable in nature and often result in smoldering heaps similar to open refuse piles.

In open refuse burning and structure fires, combustion conditions are typically poor and are highly variable because of variations in air flow, fuel moisture content, oxygen levels, material configuration, and degree of exposed surface area. In addition, some refuse or building materials may contain organic constituents that are CDD/CDF precursors or that accelerate CDD/CDF formation.

## Emission Factors

CDD/CDF emission factors have not been identified for miscellaneous open burning or structure fires. However, CDD/CDF emissions would be expected because the composition of materials burned in these fires may be the same or similar to that of municipal waste combusted in MWCs. CDD/CDF emissions from MWCs measured at the inlet to pollution control equipment (i.e., uncontrolled emissions) were previously presented (in Section 4.1). The combustion processes occurring in open-burning refuse piles or structure fires are much less efficient than those in an MWC and may provide an enhanced environment for CDD/CDF formation.

Open burning of municipal waste or construction debris containing chlorinated plastics or other chlorine-containing materials would be expected to emit levels of CDD/CDF comparable to or higher than those from uncontrolled MWC emissions. On the other hand, open burning or structure fires in which the materials being burned are low in chlorine content (e.g., wood, yard waste) would be expected to have lower CDD/CDF emissions.

### 4.9.3 Polychlorinated Biphenyls Fires

#### Process Description

Fires involving polychlorinated biphenyls (PCB)-containing electrical equipment such as transformers and capacitors can result in CDD/CDF formation and emissions. Electrical equipment containing PCB may catch fire or explode as a result of a fire in a building containing such equipment, or during lightening strikes or electrical surges.

Regulations established by EPA have reduced the chances of PCB fires by (1) requiring the removal of some large networks of PCB transformers near commercial buildings; (2) banning the installation of new PCB transformers; (3) requiring existing PCB transformers to

be equipped with enhanced electrical protection; (4) requiring the removal of combustible materials from PCB transformer locations; and (5) requiring that all PCB transformers be registered with building owners and emergency response personnel.<sup>90</sup> However, many PCB transformers and other electrical equipment are still in use and subject to accidental fires or explosions.

#### Emissions Data

Gaseous emissions from PCB fires have not been measured and CDD/CDF emission factors are not available. However, the presence of CDD/CDF in soot from PCB fires has been confirmed in several studies.<sup>91</sup> The data identified from these studies are presented below.

In Binghamton, New York, in 1981, an electrical transformer containing about 1,100 gallons of PCB was involved in an explosion. Total CDD/CDF in the soot was initially found to be as high as 4.3 lb/ton (2,160,000 ng/g). 2,3,7,8-TCDF accounted for 0.02 lb/ton (12,000 ng/g) of total CDF. HxCDF alone accounted for 1.9 lb/ton (965,000 ng/g) of total CDF. Total CDD were found at a concentration of 0.04 lb/ton (20,000 ng/g), including  $1.2 \times 10^{-3}$  lb/ton (600 ng/g) 2,3,7,8-TCDD.

In January 1982, an electrical fire involving PCB occurred in a Boston, Massachusetts, office building. One bulk soot sample contained a total of 0.23 lb/ton (115,000 ng/g) CDF, including 0.12 lb/ton (60,000 ng/g) TCDF. CDD were not detected above an analytical detection limit of  $2 \times 10^{-4}$  (100 ng/g).<sup>91</sup>

In Miami, Florida, in April 1982, a fire and explosion occurred when an underground transformer vault exploded, releasing approximately 100 gallons (379 liters) of PCB transformer oil onto the floor. Smoke ejector fans were set up to ventilate the vault. Samples of soot and other residue from the fire were collected from surfaces near the fire scene. CDD were

not detected in these samples at an analytical detection limit of  $2 \times 10^{-5}$  lb/ton (10 ng/g). One soot and dust sample contained  $3.4 \times 10^{-3}$  lb/ton (1,710 ng/g) TCDF through OCDF homologues and another soot sample contained  $1.3 \times 10^{-3}$  lb/ton (670 ng/g) TCDF through OCDF homologues. The 2,3,7,8-TCDF isomer was not detected at an analytical detection limit of  $2 \times 10^{-5}$  lb/ton (10 ng/g).<sup>91</sup>

A fire in Washington State in 1984 involved transformer oil and cores. A grab sample of the ash was analyzed and found to contain  $8.2 \times 10^{-5}$  lb/ton (41.4 ng/g) CDF and  $5.4 \times 10^{-6}$  lb/ton (2.7 ng/g) and  $5 \times 10^{-6}$  lb/ton (2.5 ng/g) of the HpCDD and OCDD homologues, respectively.<sup>91</sup>

#### Source Locations

Transformers and capacitors containing PCBs are widely distributed throughout the United States. They are located at electrical substations, in commercial and industrial buildings, mounted on utility poles, in railroad locomotives, and in mining equipment motors. Although the installation of new PCB-containing equipment has been banned and regulations regarding existing ones have been implemented, there are millions of existing PCB transformers and capacitors currently in use in the United States. Table 4-38 provides estimates of the numbers and types of PCB-containing electrical equipment in the United States in 1988.

#### 4.10 MUNICIPAL SOLID WASTE LANDFILLS

A municipal solid waste (MSW) landfill unit is a discrete area of land or an excavation that receives household waste, but is not a land application unit (i.e., for receiving sewage sludge). An MSW landfill unit may also receive other types of wastes, such as commercial solid waste, nonhazardous sludge, and industrial solid waste. CDD/CDF emissions from MSW landfills are expected to originate from the non-household sources of MSW.



TABLE 4-38. ESTIMATES OF THE NUMBER AND TYPE OF PCB-CONTAINING ELECTRICAL EQUIPMENT IN THE UNITED STATES (1988)

Equipment	PCB Content	Approximate Units
Transformers	70% (by wt.)	32,000
Capacitors	70% (by wt.)	1,500,000
Mineral Oil Transformers/Capacitors	>500 ppm	200,000
Mineral Oil Transformers/Capacitors	50-500 ppm	1,500,000
Mineral Oil Transformers/Capacitors	<50 ppm <sup>a</sup>	14,920,000
Other Electrical Equipment	<50 ppm <sup>a</sup>	700,000

Source: Reference 91.

<sup>a</sup> These units are expected to contain small quantities of PCB.

MSW management in the United States is dominated by disposal in landfills. Approximately 67 percent of solid waste is landfilled, 16 percent is incinerated, and 17 percent is recycled or composted. There were an estimated 5,345 active MSW landfills in the United States in 1992. In 1990, active landfills were receiving an estimated 130 million tons (118 million Mg) of waste annually, with 55 to 60 percent reported as household waste and 35 to 45 percent reported as commercial waste.<sup>92</sup>

#### 4.10.1 Process Description

There are three major designs for municipal landfills: the area method, the trench method, and the ramp method.<sup>92</sup> They all utilize a three-step process, which includes spreading the waste, compacting the waste, and covering the waste with soil. The area fill method involves placing waste on the ground surface or landfill liner, spreading it in layers, and compacting it with

heavy equipment. A daily soil cover is spread over the compacted waste. The trench method entails excavating trenches designed to receive a day's worth of waste. The soil from the excavation is often used for cover material and wind breaks. The ramp method is typically employed on sloping land, where waste is spread and compacted in a manner similar to the area method; however, the cover material obtained is generally from the front of the working face of the filling operation. The trench and ramp methods are not commonly used, and are not the preferred methods when liners and leachate collection systems are utilized or required by law.

Modern landfill design often incorporates liners constructed of soil (e.g., recompacted clay) or synthetics (e.g., high density polyethylene) or both to provide an impermeable barrier to leachate (i.e., water that has passed through the landfill) and gas migration from the landfill.

#### 4.10.2 Emission Control Techniques

Landfill gas collection systems are either active or passive systems. Active collection systems provide a pressure gradient in order to extract landfill gas by use of mechanical blowers or compressors. Passive systems allow the natural pressure gradient created by the increase in landfill pressure from landfill gas generation to mobilize the gas for collection.

Landfill gas control and treatment options include (1) combustion of the landfill gas, and (2) purification of the landfill gas. Combustion techniques include techniques that do not recover energy (e.g., flares and thermal incinerators) and techniques that recover energy and generate electricity from the combustion of the landfill gas (e.g., gas turbines and internal combustion engines). Boilers can also be employed to recover energy from landfill gas in the form of steam. Flares involve an open combustion process that requires oxygen for combustion; the flares can be open or enclosed. Thermal incinerators heat an organic chemical to a high enough temperature in the presence of sufficient oxygen to oxidize the chemical to CO<sub>2</sub> and

water. Purification techniques can also be used to process raw landfill gas to pipeline quality natural gas by using adsorption, absorption, and membranes.

#### 4.10.3 Emission Factors

During the development of this document, no data were identified that indicate CDD/CDF are emitted in landfill gas. However, one test report on a landfill gas flare was obtained that presents CDD/CDF emissions results.<sup>93</sup> Emission factors developed from data presented in the report are provided in Table 4-39. Results of the emissions test on the flare indicate that combustion of landfill gas may be a source of CDD/CDF emissions.

### 4.11 ORGANIC CHEMICALS MANUFACTURE AND USE

Chemical reactions involved in the manufacture of halogenated organic chemicals can produce small quantities of dioxin and furan by-products. These pollutants may be lost to the air during product manufacture or emitted later during the use of the contaminated products. This section documents potential mechanisms for CDD/CDF formation and the potential occurrence of these contaminants in the production and use of specific halogenated organic chemicals. In addition, data on actual product analysis for some of these compounds is presented. The presented information has been limited to chlorinated and brominated compounds currently produced in the United States that are most likely to be contaminated with dioxins and furans.

#### 4.11.1 General Chemical Formation Mechanisms

Four major mechanisms have been postulated for the formation of halogenated dioxins and furans in the manufacture of halogenated organic chemicals:<sup>94,95</sup> (1) direct halogenation of dioxins or furans (Figure 4-32a); (2) reaction of an ortho halogen with a phenate (Figure 4-32b); (3) loss of the halogen (e.g., chlorine or bromine) from a halogenated phenate to

TABLE 4-39. EMISSION FACTORS FROM A LANDFILL GAS  
 COMBUSTION SYSTEM<sup>a</sup>  
 SCC: 5-02-006-01  
 FACTOR QUALITY RATING: D

Isomer	lb/MMBtu	g/MJ
2,3,7,8-TCDD	$2.30 \times 10^{-12}$	$9.89 \times 10^{-13}$
1,2,3,7,8-PeCDD	$1.15 \times 10^{-11}$	$4.95 \times 10^{-12}$
1,2,3,4,6,8-HxCDD	$9.20 \times 10^{-12}$	$3.96 \times 10^{-12}$
1,2,3,4,7,8-HxCDD	$9.20 \times 10^{-12}$	$3.96 \times 10^{-12}$
1,2,3,7,8,9-HxCDD	$3.23 \times 10^{-11}$	$1.39 \times 10^{-11}$
1,2,3,4,6,7,8-HpCDD	$9.45 \times 10^{-11}$	$4.06 \times 10^{-11}$
Total OCDD	$5.52 \times 10^{-10}$	$2.37 \times 10^{-10}$
Total CDD	$7.11 \times 10^{-10}$	$3.05 \times 10^{-10}$
2,3,7,8-TCDF	$1.76 \times 10^{-9}$	$7.57 \times 10^{-10}$
1,2,3,7,8-PeCDF	$4.82 \times 10^{-11}$	$2.07 \times 10^{-11}$
2,3,4,7,8-PeCDF	$1.42 \times 10^{-10}$	$6.11 \times 10^{-11}$
1,2,3,4,7,8-HxCDF	$1.82 \times 10^{-10}$	$7.83 \times 10^{-11}$
1,2,3,6,7,8-HxCDF	$5.28 \times 10^{-11}$	$2.27 \times 10^{-11}$
1,2,3,7,8,9-HxCDF	$1.38 \times 10^{-11}$	$5.93 \times 10^{-12}$
2,3,4,6,7,8-HxCDF	$8.52 \times 10^{-11}$	$3.66 \times 10^{-11}$
1,2,3,4,6,7,8-HpCDF	$1.52 \times 10^{-10}$	$6.54 \times 10^{-11}$
1,2,3,4,7,8,9-HpCDF	$9.19 \times 10^{-12}$	$3.95 \times 10^{-12}$
Total OCDF	$7.99 \times 10^{-11}$	$3.44 \times 10^{-11}$
Total CDF	$2.53 \times 10^{-9}$	$1.09 \times 10^{-9}$

Source: Reference 93.

<sup>a</sup> Control device is an afterburner where test was taken.



**a. Halogenation of Dioxins or Furans**

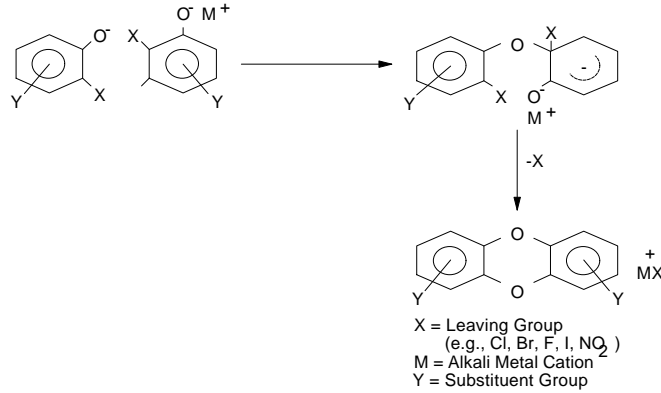

**b. Reaction of an Ortho Halogen with a Phenate**

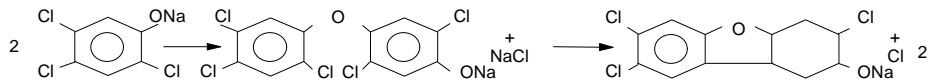

**c. Loss of Halogen (e.g., Chlorine or Bromine) from a Halogenated Phenate to form Halogenated Furans**

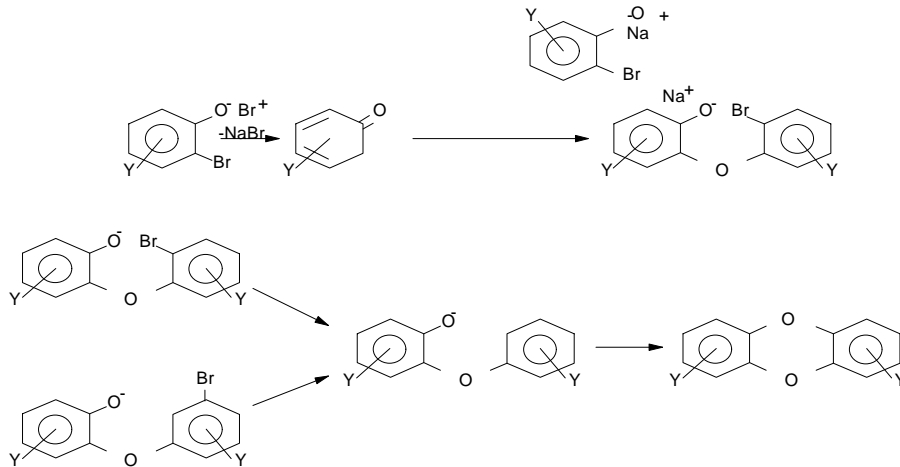

**d. Reactions Between Ortho - and Meta Substituted Halogens**

Figure 4-32(a-d). Mechanisms for Halogenated Dioxin and Furan Production

Source: References 94, 95.

form halogenated furans (Figure 4-32c); and (4) reactions between ortho- and meta-substituted halogens (Figure 4-32d).

A number of factors influence the amount of dioxins and furans that may be formed in a given manufacturing process, including temperature, pH, catalyst, and reaction kinetics.<sup>95</sup>

The effect of temperature on the formation of halogenated dioxins and furans is well recognized. A mathematical relationship between temperature and dioxin formation has been proposed to calculate the theoretical amount of dioxins that can be expected.<sup>95</sup> This relationship is expressed as:

$$7y = 0.025t^2 e^{-3|(t-200)/200|}$$

where:

y = dioxin concentration

t = temperature

This relationship, graphically represented in Figure 4-33, shows that dioxin formation peaks at 392°F (200°C) and decreases unsymmetrically with increasing temperature. The use of this predictive model also assumes that (1) impurities in the feedstock (including any dioxins) are carried through to the final product, based on the chemical stability and low concentration of dioxins formed; (2) there is a catalyst present to promote the reaction; and (3) there is no purification of the product.<sup>95</sup>

#### 4.11.2 Chlorophenols

Formation mechanisms and potential emissions of dioxins and furans for the production and use of chlorophenols are discussed in this subsection.

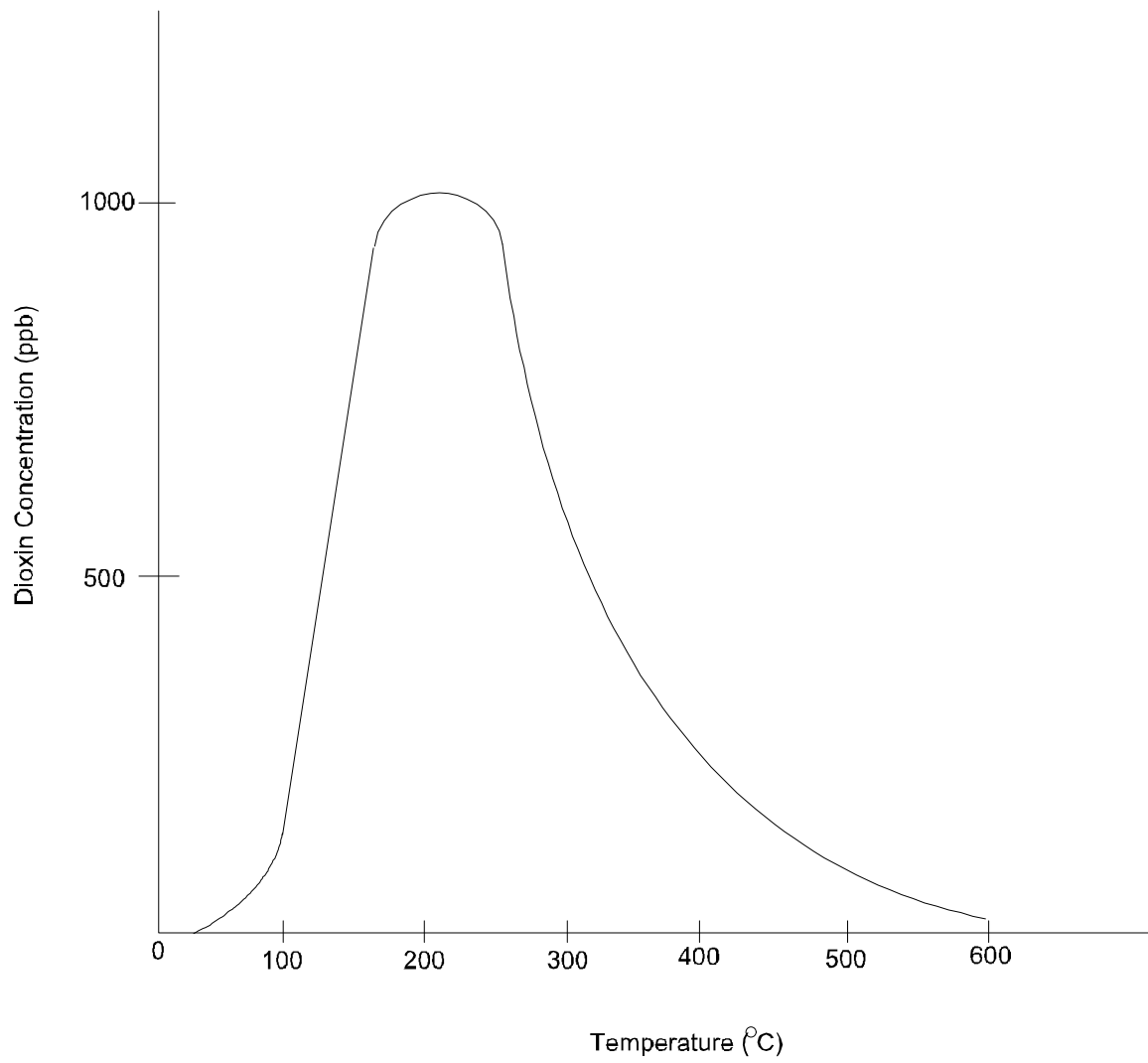

Figure 4-33. Dioxin Concentration Versus Temperature

Source: Reference 95.

## Chlorophenol Use

Since the 1950s, chlorophenols have been used as herbicides, insecticides, fungicides, mold inhibitors, antiseptics, disinfectants and, most importantly, woodpreservatives.

Polychlorinated phenols (PCP) are currently used in the United States as industrial wood preservatives. The principal and most effective method of application is pressure treating, which forces PCP into wood fibers. The bactericide, fungicide, and insecticide properties of PCP help to preserve outdoor lumber, including railroad ties, marine pilings, highway barriers, and, primarily, utility poles. All other United States uses of PCP have been discontinued.<sup>96</sup>

2,4-dichlorophenol (2,4-DCP) is produced commercially for use as an intermediate in the manufacture of industrial and agricultural products. One of the primary uses of 2,4-DCP includes feedstock for the production of 2,4-dichlorophenoxyacetic acid (2,4-D) and derivatives, which are used as pesticides, germicides, and soil sterilants. 2,4-DCP is also used in the production of certain methyl compounds used in mothproofing, antiseptics, and seed disinfectants. Furthermore, 2,4-DCP may be chlorinated with benzene sulfonyl chloride to produce miticides, or further chlorinated to produce PCP.<sup>95</sup>

## Dioxin and Furan Contamination in the Manufacture and Use of Chlorophenols

Chlorinated phenols, including DCP and PCP, are manufactured by the chlorination of the phenols using catalysts or by the alkaline hydrolysis of a chlorobenzene. Both of these reactions can produce CDD/CDF by-products that show up as contaminants in commercially produced chlorophenols and chlorophenol derivatives such as phenoxy acids. Potentially contaminated chlorophenol products and their derivatives are listed in Table 4-40. Although most of the following discussion are pertains to the formation of CDD, the reaction mechanisms for the formation of CDF the same.<sup>94</sup>



TABLE 4-40. SOME COMMERCIAL CHLOROPHENOL PRODUCTS AND DERIVATIVES THAT MAY BE CONTAMINATED WITH DIOXINS OR FURANS

Common Name	Chemical Name	Primary Use
2,4-D (esters and salts)	2,4-dichlorophenoxyacetic acid and esters and salts	Pesticide
2,4-DB and salts	2,4-dichlorophenoxybutyric	Pesticide
2,4-DP	2-2,4-dichlorophenoxy propionic acid	Pesticide
PCP and salts	Pentachlorophenol and salts	Wood treatment

Source: Reference 95.

Dioxins may form as a contaminant in commercial products by the intermolecular condensation of polyhalophenols to polyhalodibenzo-p-dioxins, including the condensation of phenates with various chlorine substituents. Condensation reactions of chlorophenols are influenced by the following factors:<sup>95</sup>

- The total number of chlorine substituents, which determines the ease of chlorine removal and the ether-bond formation.
- In the case of solid-state reactions, the arrangement of the molecules within a crystal are influenced by the metal cation involved.
- Steric effects from molecular conformations that impact site-specific nucleophilic substitution.
- Electronic effects, which allow chlorine atoms in some positions to be removed more readily than those in the other positions on the ring.

In laboratory preparations, yields of 10-20 percent have been reported for the Ullman-type self-condensation of 2,4-DCP to 2,7-dichlorodibenzo-p-dioxin.<sup>94,95</sup> Another study on the chemistry of chlorinated dioxins obtained 80 percent OCDD in the solid-state condensation of sodium pentachlorophenate molecules.<sup>94,95</sup> This high yield was attributed to lattice or steric

effects of sodium pentachlorophenate, which open the oxygen atom to attack and thus lead to dioxin formation. The same study yielded 30 percent HxCDD in the solid-state condensation of sodium 2,3,4,6-tetrachlorophenate. The lower yield and the finding of two isomers of HxCDD indicate that the tetrachlorophenate is less stereo-specific than the pentachlorophenate.

CDD Formation in PCP Manufacture--PCP may be manufactured commercially by direct chlorination of phenol or as a mixture of chlorophenols, as shown below:

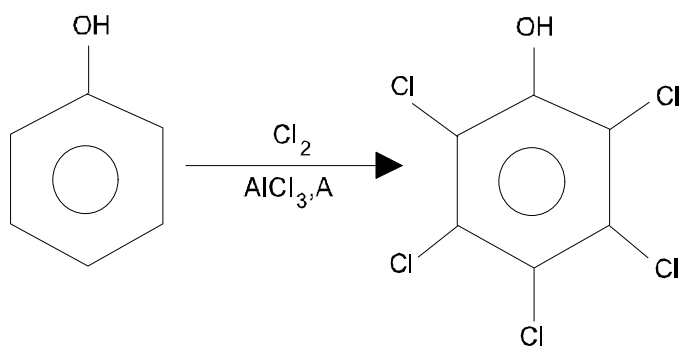

In one manufacturing process, phenol is chlorinated under anhydrous conditions, with aluminum chloride as the catalyst. In this process, three to four chlorine atoms are added to the phenol. The off-gas from the chlorinator (primarily HCl with some chlorine) is passed through a scrubber-reactor system containing excess phenol. The temperature is held at the point where the chlorine is almost completely reacted to give the lower chlorinated phenols, which may be either separated or fed back to the reactor for further chlorination.

PCP manufacture can produce a variety of CDD via phenoxy radical reactions. Specifically, phenoxy radicals are produced from decomposition of polychlorocyclohexadienones produced by excess chlorination of tri-, tetra-, or PCP. The electrophilic phenoxy radical attacks electronegative sites (ortho or para positions) on a polychlorophenol molecule to form phenoxyphenols, which undergo further reactions to form CDD. In the PCP manufacturing process, chlorination is normally stopped when 3 to 7 percent tetrachlorophenol remains. Further chlorination results in increased decomposition.

#### CDD/CDF Emissions from PCP Wood Treatment--Concentrations of CDD/CDF

vary greatly over time and are a function of heat, sunlight, and co-solvents. PCP pressure treatment of wood varies from facility to facility. However, the treatment method generally involves the following steps. First, the pre-cut wood is loaded into a pressure cylinder, which is then filled with PCP dissolved in a petroleum solvent. The cylinder is then pressurized with steam until the required amount of the preservative has been absorbed. The cylinder is then depressurized and the preservative returned to storage, and the wood is placed in a vacuum to remove excess preservative. In the final step, the wood is removed from the cylinder and allowed to cool. Figure 4-34 displays a schematic of a pressure treating plant.<sup>97</sup>

Wood treatment cylinders emit PCP in the steam that is released to the atmosphere when the cylinder is opened to remove the treated lumber. Typically, these cylinders are opened only once a day for a period of roughly 30 minutes. Evaporative losses of PCP from the hot wood surface as well as fugitive emissions from pipes and fittings occur but are roughly two orders of magnitude less than the losses from the pressure cylinder.

Emissions data from five wood treatment facilities were used to develop a 2,3,7,8-TCDD TEQ emission factor of  $7.06 \times 10^{-6}$  lb/ton of PCP used.<sup>97</sup>

CDD Formation in DCP Manufacture--Commercial manufacture of DCP involves the alkaline hydrolysis of trichlorobenzene.<sup>97</sup> 1,2,4-trichlorobenzene is reacted with sodium hydroxide in methanol at approximately 93°F (200°C) to yield the sodium salt of 2,5-, 2,4-, and 3,4-DCP, followed by acidification to produce the 2,5-, 2,4-, and 3,4-DCP products.

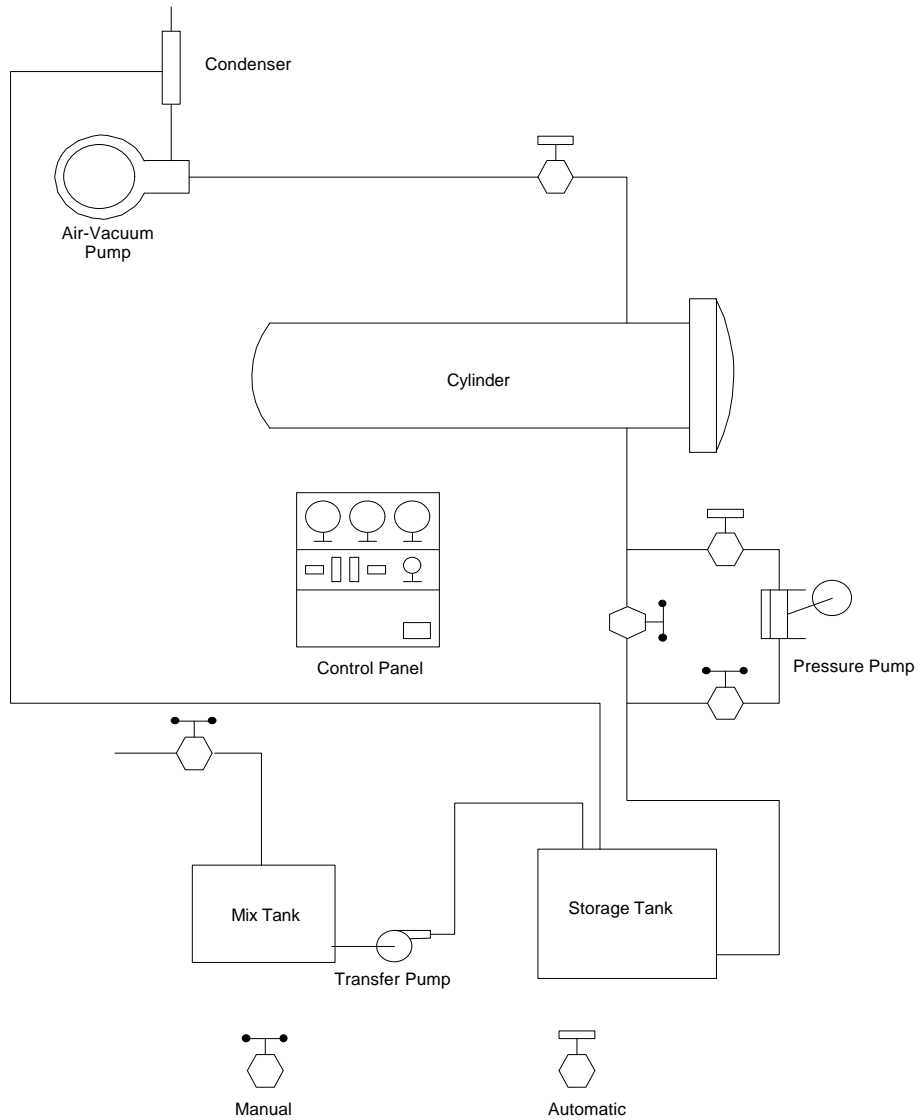

Figure 4-34. Schematic Drawing of a Pressure Treating Plant

Source: Reference 96.

The alkaline hydrolysis of 1,2,4-trichlorobenzene in the manufacture of PCP may produce CDD such as 2,7-dichlorodibenzo-p-dioxin.<sup>95</sup> In addition to alkaline hydrolysis of 1,2,4-trichlorobenzene, the use of other chlorobenzenes in the manufacture of chlorophenols may form CDD contaminants as shown in Table 4-41.

TABLE 4-41. DIOXIN CONTAMINANTS ASSOCIATED WITH CHLOROBENZENES

Chlorobenzene	Dioxin Contaminant
1,2-Dichlorobenzene	Dibenzo-p-dioxin
1,2,3-Trichlorobenzene	1,6-Dichlorodibenzo-p-dioxin
1,2,4-Trichlorobenzene	2,7-Dichlorodibenzo-p-dioxin
1,2,3,4-Tetrachlorobenzene	1,2,6,7-TCDD
1,2,3,5-Tetrachlorobenzene	1,3,6,8-TCDD
1,2,4,5-Tetrachlorobenzene	2,3,7,8-TCDD

Source: Reference 94.

#### 4.11.3 Brominated Compounds

Extensive research on CDD/CDF has produced much information on their chemistry. However, much less is known about their brominated counterparts. On the basis of laboratory studies on the formation of polybrominated dibenzo-p-dioxins (BDD) and polybrominated dibenzofurans (BDF) from certain brominated compounds, an assumption can be made that the mechanisms of dioxin and furan formation for brominated substances are similar to those for chlorinated substances.<sup>94</sup> Thus, bromine analogues of chlorinated compounds that have been associated with dioxin contamination could reasonably be expected to be associated with BDD/BDF contamination. However, unlike the high-temperature chlorination process, bromination of organic compounds is a low-temperature process. These low-temperature bromination conditions are not as conducive to the formation of dioxins.

Information on the formation of BDD/BDF provided by one study demonstrated that they could be formed during the chemical synthesis of flame retardants such as 2,4,6-tribromophenol, pentabromophenol, and tetrabromobisphenol A. Combustion of these flame retardants also resulted in formation of BDD/BDF. High-resolution capillary column gas chromatography coupled with mass spectrometry (HRGC/MS) analysis of 2,4,6-tribromophenol indicated the presence of di- and tri-BDD, TBDD, PeBDF, HxBDF, HpBDF, and OBDF.<sup>94</sup>

Table 4-42 contains profiles of some industrial brominated chemicals, and include information on the manufacturing process, possible contaminants, and most likely BDD/BDF isomers. The predicted number of possible BDD/BDF formation pathways are given in Table 4-43.

#### 4.12 PORTLAND CEMENT PRODUCTION

Most of the hydraulic cement produced in the United States is Portland cement, which is a cementitious, crystalline compound composed of metallic oxides. The end-product cement, in its fused state, is referred to as "clinker." Raw materials used in the process can be calcium carbonate- and aluminum-containing limestone, iron, silicon oxides, shale, clay, and sand.<sup>98</sup> There are four primary components in Portland cement manufacturing: raw materials handling, kiln feed preparation, pyroprocessing, and finished cement grinding. Pyroprocessing, the fuel intensive process accomplished in cement kilns, has been identified as a potential source of CDD/CDF emissions and constitutes the primary focus of this chapter.

##### 4.12.1 Process Description

In Portland cement production, most raw materials typically are quarried on site and transferred by conveyor to crushers and raw mills. After the raw materials are reduced to the desired particle size, they are blended and fed to a large rotary kiln. The feed enters the kiln at the elevated end, and the burner is located at the opposite end. The raw materials are then changed into cementitious oxides of metal by a countercurrent heat exchange process. The materials are

TABLE 4-42. INDUSTRIAL BROMINATED COMPOUNDS

Compound	Manufacturing Process	Possible Contaminants	Most Likely BDD/BDF Isomers
2,4-Dibromophenol	Bromination of phenol in water or another polar hydroxylic solvent.	2,4,6-Tribromophenol; 2,4,5-tribromophenol; and possibly tetrabromophenol and pentabromophenol.	2,7-Dibromodibenzo-p-dioxin.
2,4,6-Tribromophenol	Bromination of phenol in the presence of water or other polar hydroxylic solvent; reaction is uncatalyzed.	2,4,5-Tribromophenol; tetrabromophenols.	2,4,7,9-Tetrabromodibenzo-p-dioxin.
Bromophenols (o-,m-, and p-isomers)	Bromination of phenol in water or another hydroxylic solvent.	Phenol, dibromophenol.	Unfavorable kinetics and thermodynamic conditions. Low probability of BDDs and/or BDFs formation. Possible mono/dibromdibenzodioxin isomer.
2,6-Dibromo-4-nitrophenol	Bromination of p-nitrophenol with excess Br <sub>2</sub> ; catalyst is probably not necessary.	2,5-Dibromo-4-nitrophenol.	None, due to steric hindrance and other effects from NO <sub>2</sub> groups on aromatic ring.
Decabromodiphenyloxide	Perbromination of diphenyloxide with at least 150 percent excess Br <sub>2</sub> in the presence of AlBr <sub>3</sub> at 95°F (35°C), followed by an increase in temperature to around 140°F (60°C).	Diphenyloxide with varying degrees of bromination.	Octabromodibenzofuran.
Octabromodiphenyloxide	Bromination of benzene with Br <sub>2</sub> and FeCl <sub>3</sub> as catalyst 176 to 212°F (80 to 100°C).	Varying degrees of brominated benzene.	Depends on the particular bromobenzene.
Pentabromotoluene	Perbromination at room temperature in presence of catalyst (U.S. Patent No. 4287373, Great Lakes Chemical Corporation, 1981).	Varying brominated toluenes.	BDDs and BDFs could be formed under combustion conditions similar to that of the chlorinated benzenes in PCBs transformers. The specific isomers depends on the condensation of the particular brominated toluenes, several dimethyl polybrominated dioxins and furans are possible.

TABLE 4-42. INDUSTRIAL BROMINATED COMPOUNDS (CONTINUED)

Compound	Manufacturing Process	Possible Contaminants	Most Likely BDD/BDF Isomers
Tetrabromophthalic Anhydride	U.S. Patent No. 3382254, Chemische Fabrik Kalk GMBH DE, 1968: phthalic anhydride, in 50-80 percent oleum, is brominated using halogenation catalyst at 176 to 194 °F (80 to 90 °C); then, temperature is raised to about 221 °F (100 to 110 °C) at end of Br <sub>2</sub> addition; then, heat to 248 to 302 °F (120 to 150 °C) to get rid of excess SO <sub>3</sub> and Br reactants.	Phthalic anhydride with varying degrees of bromination.	None.
1,2,4-Tribromobenzene	By-product from the preparation of 1,3,5-tribromobenzene.	See bromobenzene and pentabromotoluene.	See bromophenols and pentabromotoluene.
1,3,5-Tribromobenzene	Bromination of benzene with Br <sub>2</sub> using AlBr <sub>3</sub> as catalyst; since 1,3,5-isomer is most stable, will tend toward this configuration (yield 1,3,5-isomer ≥ 50 percent).	See 1,2,4-tribromobenzene.	See 1,2,4-tribromobenzene.
Tetrabromobisphenol A	Bromination of bisphenol A in organic solvent with Br <sub>2</sub> at 68 to 104 °F (20 to 40 °C) and then increasing incubation temperature to 149 to 158 °F (65 to 70 °C).	Brominated phenols.	Octabromodibenzo-p-dioxin.

Source: Reference 94.



TABLE 4-43. BROMINATED COMPOUNDS WITH THE POTENTIAL FOR BDD/BDF FORMATION

Chemical Name	Predicted Number of Possible BDD/BDF Formation Pathways
2,4-Dibromophenol	5
2,4,6-Tribromophenol	2
o-, m-, and p-Bromophenol	2
2,6-Dibromo-4-nitrophenol	1
Decabromodiphenyloxide	1
Octabromodiphenyloxide	1
Bromobenzene (mono- and di-)	0 <sup>a</sup>
Pentabromotoluene	0 <sup>b</sup>
Tetrabromophthalic anhydride	0
1,2,4-Tribromobenzene	0 <sup>a,b</sup>
1,3,5-Tribromobenzene	0 <sup>a,b</sup>
Pentabromodiphenyloxide	1
Tetrabromobisphenol A	1

Source: Reference 94.

<sup>a</sup> Under combustion conditions, brominated benzenes could condense to BDD and BDF similar to chlorinated benzenes.

<sup>b</sup> BDD and BDF could be formed under combustion conditions similar to those of chlorinated benzenes in PCB transformers.

continuously and slowly moved to the low end by the rotation of the kiln while being heated to high temperatures (2,700°F [1,482°C]) by direct firing. In this stage, chemical reactions occur, and a rock-like substance called "clinker" is formed. This clinker is then cooled, crushed, and blended with gypsum to produce Portland cement.<sup>98</sup> The cement is then either bagged or bulk-loaded and transported out.<sup>98</sup>

Cement may be made via a wet or a dry process. Many older kilns use the wet process. In the past, wet grinding and mixing technologies provided more uniform and consistent material mixing, resulting in a higher quality clinker. Dry process technologies have improved, however, to the point that all of the new kilns since 1975 use the dry process.<sup>100</sup> In the wet process, water is added to the mill while the raw materials are being ground. The resulting slurry is fed to the kiln. In the dry process, raw materials are also ground finely in a mill, but no water is added and the feed enters the kiln in a dry state.

More fuel is required for the wet process than the dry process to evaporate the water from the feed. However, for either the wet or dry process, Portland cement production is fuel-intensive. The primary fuel burned in the kiln may be natural gas, oil, or coal. Many cement plants burn supplemental fuels such as waste solvents, chipped rubber, shredded municipal garbage, and coke.<sup>98</sup> A major trend in the industry is the increased use of waste fuels. In 1989, 33 plants in the United States and Canada reported using waste fuels; the number increased to 55 plants in 1990.<sup>98</sup>

The increased use of hazardous waste-derived fuels (HWDFs) for the kilns is attributed to lower cost and increased availability. As waste generators reduce or eliminate solvents from their waste streams, the streams contain more sludge and solids. As a result, two new hazardous waste fueling methods have emerged at cement kilns. The first method pumps solids (either slurried with liquids or dried and ground) into the hot end of the kiln. The second method (patented by cement kiln processor and fuel blender Cadence, Inc.) introduces containers of solid waste into the calcining zone of the kiln.<sup>100</sup>

The kiln system for the manufacture of Portland cement by dry process with preheater is shown in Figure 4-35. The raw material enters a four-stage suspension preheater, where hot gases from the kiln heat the raw feed and provide about 40-percent calcination before the feed enters the kiln. Some installations include a precalcining furnace, which provides about 85-percent calcination before the feed enters the kiln.<sup>98</sup>

Facilities that burn HWDF are subject to the Boilers and Industrial Furnaces (BIF) rule under the Resource Conservation and Recovery Act (RCRA) promulgated February 21, 1991. The BIF rule requires that a facility that burns hazardous waste demonstrate a 99.99 percent destruction efficiency for principal organic hazardous constituents in the waste stream. To guard against products of incomplete combustion, the BIF rule limits CO levels in the kiln and or total hydrocarbon levels in stack gases.<sup>100,101</sup> In addition, a NESHAP for control of HAPs from Portland cement kilns is under development by the Emission Standards Division of OAQPS.

#### 4.12.2 Emission Control Techniques

Fuel combustion at Portland cement plants can emit a wide range of pollutants in small quantities. If the combustion reactions do not reach completion, CO and VOCs can be emitted. When waste fuels are burned, incomplete combustion can lead to emissions of specific HAPs, such as CDD/CDF. These pollutants are generally emitted at low levels.

In the pyroprocessing units, control devices employed are fabric filters (reverse air, pulse jet, or pulse plenum) and ESPs. Typical control measures for the kiln exhaust are reverse air fabric filters with an air-to-cloth ratio of 0.41:1 meter per minute (m/min) (1.5:1 acfm/ft<sup>2</sup>) and ESPs with a net specific collecting area (SCA) of 1,140 to 1,620 square meters per thousand m<sup>3</sup> (m<sup>2</sup>/1,100 m<sup>3</sup>) (350 to 500 square feet per thousand ft<sup>3</sup> [ft<sup>2</sup>/1,000 ft<sup>3</sup>]). Clinker cooler systems are controlled most frequently with pulse jet or pulse plenum fabric filters. The potential for secondary CDD/CDF formation exists within the ESP. CDD/CDF formation can occur in the

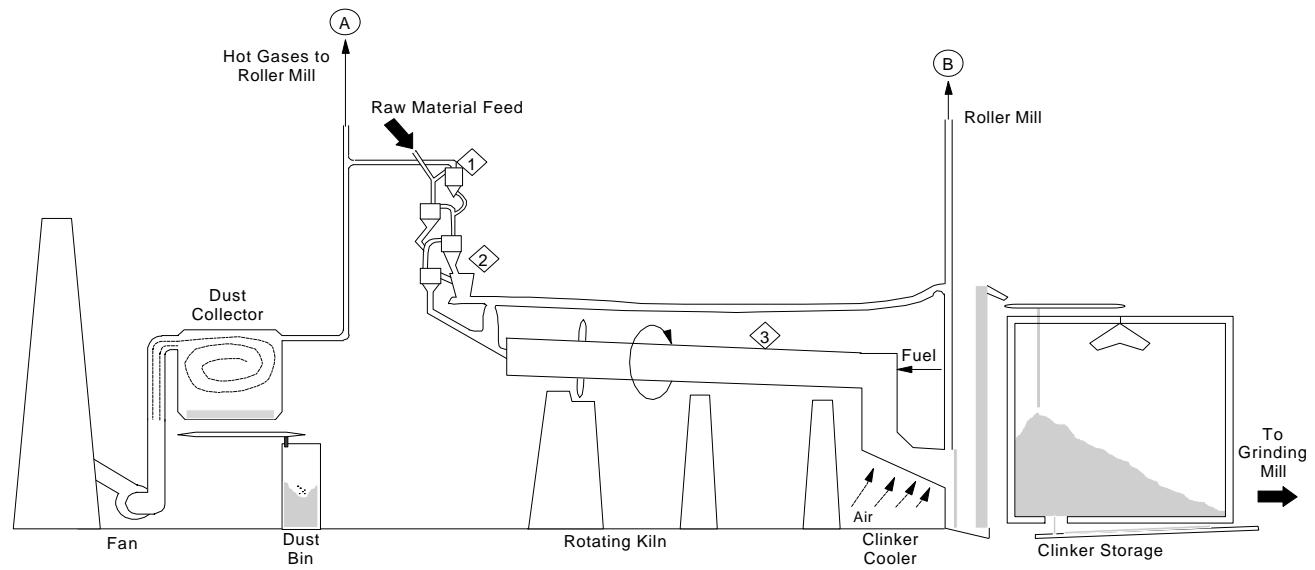

Figure 4-35. Process Diagram of Portland Cement Manufacturing by Dry Process with Preheater

Source: Reference 98.

presence of excess oxygen over a wide range of temperatures. Refer to Section 4.1.1 for a detailed discussion.

#### 4.12.3 Emission Factors

The raw materials used by some facilities may contain organic compounds, which constitute a precursor to potential CDD/CDF formation during the heating step. However, fuel combustion to heat the kiln is believed to be the greater source of CDD/CDF emissions. The data collected and presented in this section indicate that CDD/CDF are emitted when either fossil fuels, HWDFs, or combinations of the two are combusted in the kiln.<sup>98,101</sup>

CDD/CDF emissions data for Portland cement kilns with various process, fuel, and control configurations were compiled by the U.S. EPA's Office of Solid Waste in 1994.<sup>101</sup> Testing was conducted at 35 Portland cement manufacturing facilities to certify compliance with the BIF Rule. Emission factors developed from the study are presented in Tables 4-44 and 4-45.

It should be noted that Table 4-44 presents emission factors for kilns that burn hazardous waste (HW) and also kilns that do not burn hazardous waste (NHW). In addition, this document presents separate emissions estimates for HW and NHW kilns.

#### 4.12.4 Source Locations

The Portland cement manufacturing industry is dispersed geographically throughout the United States. Thirty-six states have at least one facility. As of December 1990, there were 112 operating Portland cement plants in the United States, operating 213 kilns with a total annual clinker capacity of approximately 80 million tons (73.7 million Mg). The kiln population included 80 wet process kilns and 133 dry process kilns.<sup>98</sup> Table 4-46 presents the number of Portland cement plants and kilns in the United States by State and the associated production capacities as of December 1990.

TABLE 4-44. CDD/CDF EMISSION FACTORS FOR DRY PROCESS PORTLAND CEMENT KILNS

SCC 3-05-006-06  
 FACTOR QUALITY RATING: D

Fuel Type	Control Device	Pollutant	Average Emission Factor in lb/ton (kg/Mg) <sup>a</sup>
Natural Gas	Electrostatic Precipitator <sup>b</sup>	2,3,7,8-TCDD	1.20x10 <sup>-10</sup> (6.00x10 <sup>-11</sup> )
		Total TCDD	4.93x10 <sup>-9</sup> (2.47x10 <sup>-9</sup> )
		Total PeCDD	1.12x10 <sup>-9</sup> (5.60x10 <sup>-10</sup> )
		Total HxCDD	4.73x10 <sup>-10</sup> (2.37x10 <sup>-10</sup> )
		Total HpCDD	3.07x10 <sup>-10</sup> (1.54x10 <sup>-10</sup> )
		Total OCDD	1.98x10 <sup>-9</sup> (9.90x10 <sup>-10</sup> )
		Total CDD	8.81x10 <sup>-9</sup> (4.41x10 <sup>-9</sup> )
		2,3,7,8-TCDF	2.98x10 <sup>-9</sup> (1.49x10 <sup>-9</sup> )
		Total TCDF	2.24x10 <sup>-8</sup> (1.12x10 <sup>-8</sup> )
		Total PeCDF	4.29x10 <sup>-9</sup> (2.15x10 <sup>-9</sup> )
		Total HxCDF	5.47x10 <sup>-10</sup> (2.74x10 <sup>-10</sup> )
		Total HpCDF	3.55x10 <sup>-11</sup> (1.78x10 <sup>-11</sup> )
		Total OCDF	6.62x10 <sup>-11</sup> (3.31x10 <sup>-11</sup> )
		Total CDF	2.72x10 <sup>-8</sup> (1.36x10 <sup>-8</sup> )
		Coal/Coke	Electrostatic Precipitator <sup>b</sup>
Total TCDD	1.73x10 <sup>-7</sup> (8.65x10 <sup>-8</sup> )		
Total PeCDD	2.62x10 <sup>-9</sup> (1.31x10 <sup>-9</sup> )		
Total HxCDD	2.53x10 <sup>-9</sup> (1.27x10 <sup>-9</sup> )		
Total HpCDD	1.61x10 <sup>-9</sup> (8.05x10 <sup>-10</sup> )		
Total OCDD	1.42x10 <sup>-9</sup> (7.10x10 <sup>-10</sup> )		
Total CDD	1.01x10 <sup>-8</sup> (5.05x10 <sup>-9</sup> )		
2,3,7,8-TCDF	4.48x10 <sup>-9</sup> (2.24x10 <sup>-9</sup> )		
Total TCDF	2.43x10 <sup>-8</sup> (1.22x10 <sup>-8</sup> )		

TABLE 4-44. CDD/CDF EMISSION FACTORS FOR DRY PROCESS PORTLAND CEMENT KILNS (CONTINUED)

Fuel Type	Control Device	Pollutant	Average Emission Factor in lb/ton (kg/Mg) <sup>a</sup>
Coal/Coke, continued	Electrostatic Precipitator, <sup>b</sup> continued	Total PeCDF	1.20x10 <sup>-8</sup> (6.00x10 <sup>-9</sup> )
		Total HxCDF	7.79x10 <sup>-9</sup> (3.90x10 <sup>-9</sup> )
		Total HpCDF	2.12x10 <sup>-9</sup> (1.06x10 <sup>-9</sup> )
		Total OCDF	2.86x10 <sup>-10</sup> (1.43x10 <sup>-10</sup> )
		Total CDF	4.64x10 <sup>-8</sup> (2.32x10 <sup>-8</sup> )
Coal	Electrostatic Precipitator <sup>c</sup>	2,3,7,8-TCDD	5.14x10 <sup>-8</sup> (2.57x10 <sup>-8</sup> )
		Total TCDD	2.54x10 <sup>-6</sup> (1.27x10 <sup>-6</sup> )
		Total PeCDD	2.67x10 <sup>-6</sup> (1.34x10 <sup>-6</sup> )
		Total HxCDD	2.73x10 <sup>-6</sup> (1.37x10 <sup>-6</sup> )
		Total HpCDD	5.42x10 <sup>-7</sup> (2.71x10 <sup>-7</sup> )
		Total OCDD	8.87x10 <sup>-8</sup> (4.44x10 <sup>-8</sup> )
		Total CDD	8.62x10 <sup>-6</sup> (4.31x10 <sup>-6</sup> )
		2,3,7,8-TCDF	3.30x10 <sup>-7</sup> (1.65x10 <sup>-7</sup> )
		Total TCDF	8.45x10 <sup>-6</sup> (4.23x10 <sup>-6</sup> )
		Total PeCDF	4.53x10 <sup>-6</sup> (2.27x10 <sup>-6</sup> )
		Total HxCDF	1.71x10 <sup>-6</sup> (8.55x10 <sup>-7</sup> )
		Total HpCDF	3.15x10 <sup>-7</sup> (1.58x10 <sup>-7</sup> )
		Total OCDF	5.08x10 <sup>-8</sup> (2.54x10 <sup>-8</sup> )
		Total CDF	1.54x10 <sup>-5</sup> (7.69x10 <sup>-6</sup> )
		Coke/Hazardous Waste	Electrostatic Precipitator <sup>d</sup>
Total TCDD	5.86x10 <sup>-7</sup> (2.93x10 <sup>-7</sup> )		
Total PeCDD	4.67x10 <sup>-7</sup> (2.34x10 <sup>-7</sup> )		
Total HxCDD	4.59x10 <sup>-7</sup> (2.30x10 <sup>-7</sup> )		
Total HpCDD	5.45x10 <sup>-8</sup> (2.73x10 <sup>-8</sup> )		
Total OCDD	1.88x10 <sup>-8</sup> (9.40x10 <sup>-9</sup> )		
		Total CDD	1.62x10 <sup>-6</sup> (8.10x10 <sup>-7</sup> )

TABLE 4-44. CDD/CDF EMISSION FACTORS FOR DRY PROCESS PORTLAND CEMENT KILNS (CONTINUED)

Fuel Type	Control Device	Pollutant	Average Emission Factor in lb/ton (kg/Mg) <sup>a</sup>
Coke/ Hazardous Waste, continued	Electrostatic Precipitator, <sup>d</sup> continued	2,3,7,8-TCDF	2.07x10 <sup>-7</sup> (1.04x10 <sup>-7</sup> )
		Total TCDF	5.18x10 <sup>-6</sup> (2.59x10 <sup>-6</sup> )
		Total PeCDF	9.95x10 <sup>-7</sup> (4.98x10 <sup>-7</sup> )
		Total HxCDF	5.70x10 <sup>-7</sup> (2.85x10 <sup>-7</sup> )
		Total HpCDF	2.28x10 <sup>-8</sup> (1.14x10 <sup>-8</sup> )
		Total OCDF	7.74x10 <sup>-9</sup> (3.87x10 <sup>-9</sup> )
		Total CDF	6.98x10 <sup>-6</sup> (3.49x10 <sup>-6</sup> )
Coke	Multicyclone/Fabric Filter <sup>e</sup>	2,3,7,8-TCDD	1.19x10 <sup>-11</sup> (5.95x10 <sup>-12</sup> )
		Total TCDD	2.47x10 <sup>-9</sup> (1.24x10 <sup>-9</sup> )
		Total PeCDD	3.28x10 <sup>-9</sup> (1.64x10 <sup>-9</sup> )
		Total HxCDD	7.67x10 <sup>-9</sup> (3.84x10 <sup>-9</sup> )
		Total HpCDD	8.52x10 <sup>-10</sup> (4.26x10 <sup>-10</sup> )
		Total OCDD	1.88x10 <sup>-8</sup> (9.40x10 <sup>-9</sup> )
		Total CDD	3.31x10 <sup>-8</sup> (1.65x10 <sup>-8</sup> )
		2,3,7,8-TCDF	5.83x10 <sup>-10</sup> (2.92x10 <sup>-10</sup> )
		Total TCDF	3.80x10 <sup>-9</sup> (1.90x10 <sup>-9</sup> )
		Total PeCDF	7.84x10 <sup>-10</sup> (3.92x10 <sup>-10</sup> )
		Total HxCDF	2.25x10 <sup>-10</sup> (1.13x10 <sup>-10</sup> )
		Total HpCDF	4.68x10 <sup>-11</sup> (2.34x10 <sup>-11</sup> )
		Total OCDF	2.81x10 <sup>-10</sup> (1.41x10 <sup>-10</sup> )
		Total CDF	5.72x10 <sup>-9</sup> (2.86x10 <sup>-9</sup> )

Source: Reference 101.

<sup>a</sup> Emission factors in lb (kg) of pollutant emitted per ton (Mg) of clinker produced.

<sup>b</sup> Kiln operating conditions: high combustion temperature; minimum electrostatic precipitator power.

<sup>c</sup> Kiln operating conditions: maximum feed, kilns 1 and 2.

<sup>d</sup> Kiln operating conditions: maximum hazardous waste feed.

<sup>e</sup> Kiln operating conditions: high combustion temperature; maximum production.



TABLE 4-45. CDD/CDF EMISSION FACTORS FOR WET PROCESS  
PORTLAND CEMENT KILNS

SCC 3-05-007-06  
FACTOR QUALITY RATING: D

Fuel Type	Control Device	Pollutant	Average Emission Factor in lb/ton (kg/Mg) <sup>a</sup>
Coal	Electrostatic Precipitator <sup>b</sup>	2,3,7,8-TCDD	6.41x10 <sup>-9</sup> (3.21x10 <sup>-9</sup> )
		Total TCDD	4.74x10 <sup>-7</sup> (2.37x10 <sup>-7</sup> )
		Total PeCDD	6.63x10 <sup>-7</sup> (3.32x10 <sup>-7</sup> )
		Total HxCDD	6.52x10 <sup>-7</sup> (3.26x10 <sup>-7</sup> )
		Total HpCDD	1.02x10 <sup>-7</sup> (5.10x10 <sup>-8</sup> )
		Total OCDD	2.21x10 <sup>-7</sup> (1.11x10 <sup>-7</sup> )
		Total CDD	2.12x10 <sup>-6</sup> (1.06x10 <sup>-6</sup> )
		2,3,7,8-TCDF	3.73x10 <sup>-8</sup> (1.87x10 <sup>-8</sup> )
		Total TCDF	1.77x10 <sup>-7</sup> (8.85x10 <sup>-8</sup> )
		Total PeCDF	9.52x10 <sup>-8</sup> (4.76x10 <sup>-8</sup> )
		Total HxCDF	1.21x10 <sup>-7</sup> (6.05x10 <sup>-8</sup> )
		Total HpCDF	2.90x10 <sup>-8</sup> (1.45x10 <sup>-8</sup> )
		Total OCDF	7.92x10 <sup>-9</sup> (3.96x10 <sup>-9</sup> )
		Total CDF	4.67x10 <sup>-7</sup> (2.34x10 <sup>-7</sup> )
Coal/Coke	Electrostatic Precipitator <sup>b</sup>	2,3,7,8-TCDD	2.65x10 <sup>-10</sup> (1.33x10 <sup>-10</sup> )
		Total TCDD	1.13x10 <sup>-7</sup> (5.65x10 <sup>-8</sup> )
		Total PeCDD	1.61x10 <sup>-7</sup> (8.05x10 <sup>-8</sup> )
		Total HxCDD	2.77x10 <sup>-7</sup> (1.39x10 <sup>-7</sup> )
		Total HpCDD	3.50x10 <sup>-8</sup> (1.75x10 <sup>-8</sup> )
		Total OCDD	1.02x10 <sup>-8</sup> (5.10x10 <sup>-9</sup> )
		Total CDD	5.96x10 <sup>-7</sup> (2.98x10 <sup>-7</sup> )
		2,3,7,8-TCDF	1.55x10 <sup>-8</sup> (7.75x10 <sup>-9</sup> )
		Total TCDF	8.07x10 <sup>-8</sup> (4.04x10 <sup>-8</sup> )
		Total PeCDF	3.37x10 <sup>-8</sup> (1.69x10 <sup>-8</sup> )

TABLE 4-45. CDD/CDF EMISSION FACTORS FOR WET PROCESS  
PORTLAND CEMENT KILNS (CONTINUED)

Fuel Type	Control Device	Pollutant	Average Emission Factor in lb/ton (kg/Mg) <sup>a</sup>
Coal/Coke, continued	Electrostatic Precipitator, <sup>b</sup> continued	Total HxCDF	1.03x10 <sup>-8</sup> (5.15x10 <sup>-9</sup> )
		Total HpCDF	2.27x10 <sup>-9</sup> (1.14x10 <sup>-9</sup> )
		Total OCDF	2.42x10 <sup>-10</sup> (1.21x10 <sup>-10</sup> )
		Total CDF	1.27x10 <sup>-7</sup> (6.35x10 <sup>-8</sup> )
	Electrostatic Precipitator <sup>b</sup>	2,3,7,8-TCDD	4.17x10 <sup>-10</sup> (2.09x10 <sup>-10</sup> )
Total TCDD		2.08x10 <sup>-7</sup> (1.04x10 <sup>-7</sup> )	
Total PeCDD		2.96x10 <sup>-7</sup> (1.48x10 <sup>-7</sup> )	
Total HxCDD		8.51x10 <sup>-7</sup> (4.26x10 <sup>-7</sup> )	
Total HpCDD		1.02x10 <sup>-7</sup> (5.10x10 <sup>-8</sup> )	
Total OCDD		2.54x10 <sup>-8</sup> (1.27x10 <sup>-8</sup> )	
Total CDD		1.48x10 <sup>-6</sup> (7.41x10 <sup>-7</sup> )	
2,3,7,8-TCDF		2.54x10 <sup>-8</sup> (1.27x10 <sup>-8</sup> )	
Total TCDF		1.34x10 <sup>-7</sup> (6.70x10 <sup>-8</sup> )	
Total PeCDF		5.00x10 <sup>-8</sup> (2.50x10 <sup>-8</sup> )	
Total HxCDF		2.31x10 <sup>-8</sup> (1.16x10 <sup>-8</sup> )	
Total HpCDF		8.71x10 <sup>-9</sup> (4.36x10 <sup>-9</sup> )	
Total OCDF		4.30x10 <sup>-9</sup> (2.15x10 <sup>-9</sup> )	
Total CDF		2.46x10 <sup>-7</sup> (1.23x10 <sup>-7</sup> )	

Source: Reference 101.

<sup>a</sup> Emission factors in lb (kg) of pollutant emitted per ton (Mg) of clinker produced.

<sup>b</sup> Kiln operating conditions: high combustion temperature; minimum electrostatic precipitator power.

TABLE 4-46. SUMMARY OF PORTLAND CEMENT  
PLANT CAPACITY INFORMATION

Location	Number of Plants (kilns)	Capacity 10 <sup>3</sup> tons/yr (10 <sup>3</sup> Mg/yr)
Alabama	5 (6)	4,260 (3,873)
Alaska	1 (0) <sup>a</sup>	0 (0)
Arizona	2 (7)	1,770 (1,609)
Arkansas	2 (5)	1,314 (1,195)
California	12 (20)	10,392 (9,447)
Colorado	3 (5)	1,804 (1,640)
Florida	6 (8)	3,363 (3,057)
Georgia	2 (4)	1,378 (1,253)
Hawaii	1 (1)	263 (239)
Idaho	1 (2)	210 (191)
Illinois	4 (8)	2,585 (2,350)
Indiana	4 (8)	2,830 (2,573)
Iowa	4 (7)	2,806 (2,551)
Kansas	4 (11)	1,888 (1,716)
Kentucky	1 (1)	724 (658)
Maine	1 (1)	455 (414)
Maryland	3 (7)	1,860 (1,691)
Michigan	5 (9)	4,898 (4,453)
Mississippi	1 (1)	504 (458)
Missouri	5 (7)	4,677 (4,252)
Montana	2 (2)	592 (538)
Nebraska	1 (2)	961 (874)
Nevada	1 (2)	415 (377)
New Mexico	1 (2)	494 (449)
New York	4 (5)	3,097 (2,815)
Ohio	4 (5)	1,703 (1,548)

TABLE 4-46. SUMMARY OF PORTLAND CEMENT  
PLANT CAPACITY INFORMATION (CONTINUED)

Location	Number of Plants (kilns)	Capacity 10 <sup>3</sup> tons/yr (10 <sup>3</sup> Mg/yr)
Oklahoma	3 (7)	1,887 (1,715)
Oregon	1 (1)	480 (436)
Pennsylvania	11 (24)	6,643 (6,039)
South Carolina	3 (7)	2,579 (2,345)
South Dakota	1 (3)	766 (696)
Tennessee	2 (3)	1,050 (955)
Texas	12 (20)	8,587 (7,806)
Utah	2 (3)	928 (844)
Virginia	1 (5)	1,117 (1,015)
Washington	1 (1)	473 (430)
West Virginia	1 (3)	822 (747)
Wyoming	1 (1)	461 (419)

Source: Reference 98.

<sup>a</sup> Grinding plant only.

## SECTION 5.0

### SOURCE TEST PROCEDURES

Several sampling and analysis techniques have been employed for determining CDD and CDF emissions. Measurement of CDD and CDF involves three steps: (1) sample collection; (2) sample recovery and preparation; and (3) quantitative analysis. This section briefly describes general methodologies associated with each of these steps. The purpose of this section is to present basic sampling and analysis principles used to gather emissions data on CDD and CDF from stationary sources. The presentation of non-EPA methods in this report does not constitute endorsement or recommendation or signify that their contents necessarily reflect EPA's views and policies.

#### 5.1 SAMPLE COLLECTION

Collection of CDD and CDF from stationary sources is achieved by using a sampling system that captures both particulate and condensibles. The most prevalent method is EPA Method 0010, also referred to as the Modified Method 5 (MM5) Sampling Train, which is equipped with a sorbent resin for collecting condensibles. A schematic of the MM5 sampling train used for collecting CDD and CDF is shown in Figure 5-1.

The Source Assessment Sampling System (SASS), a high-volume variation of MM5 capable of sampling particulate and vapor emissions from stationary sources has also been used.<sup>102,103</sup> A schematic of the SASS train is shown in Figure 5-2.

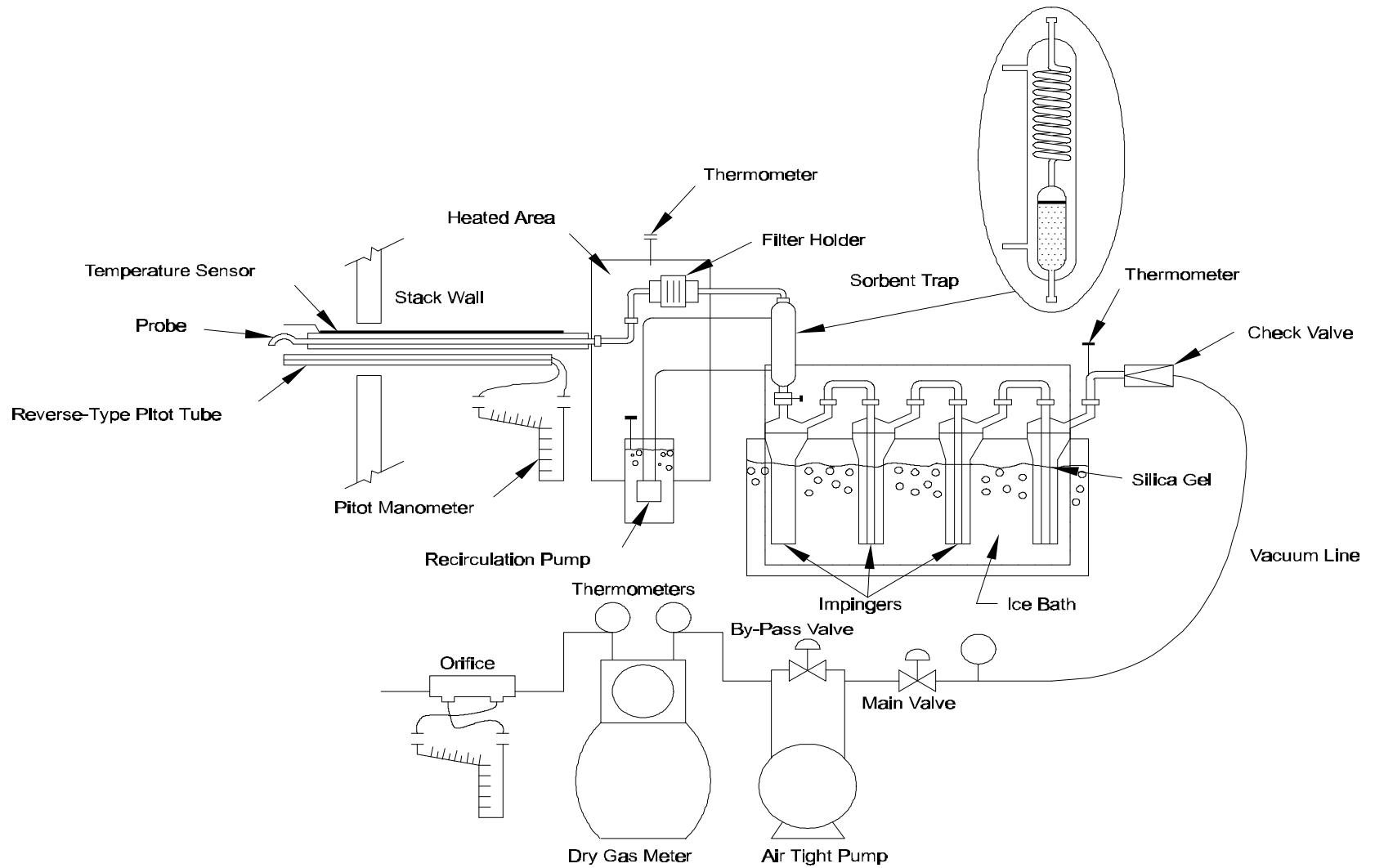

Figure 5-1. Modified Method 5 Sampling Train Configuration

Source: References 102,103.

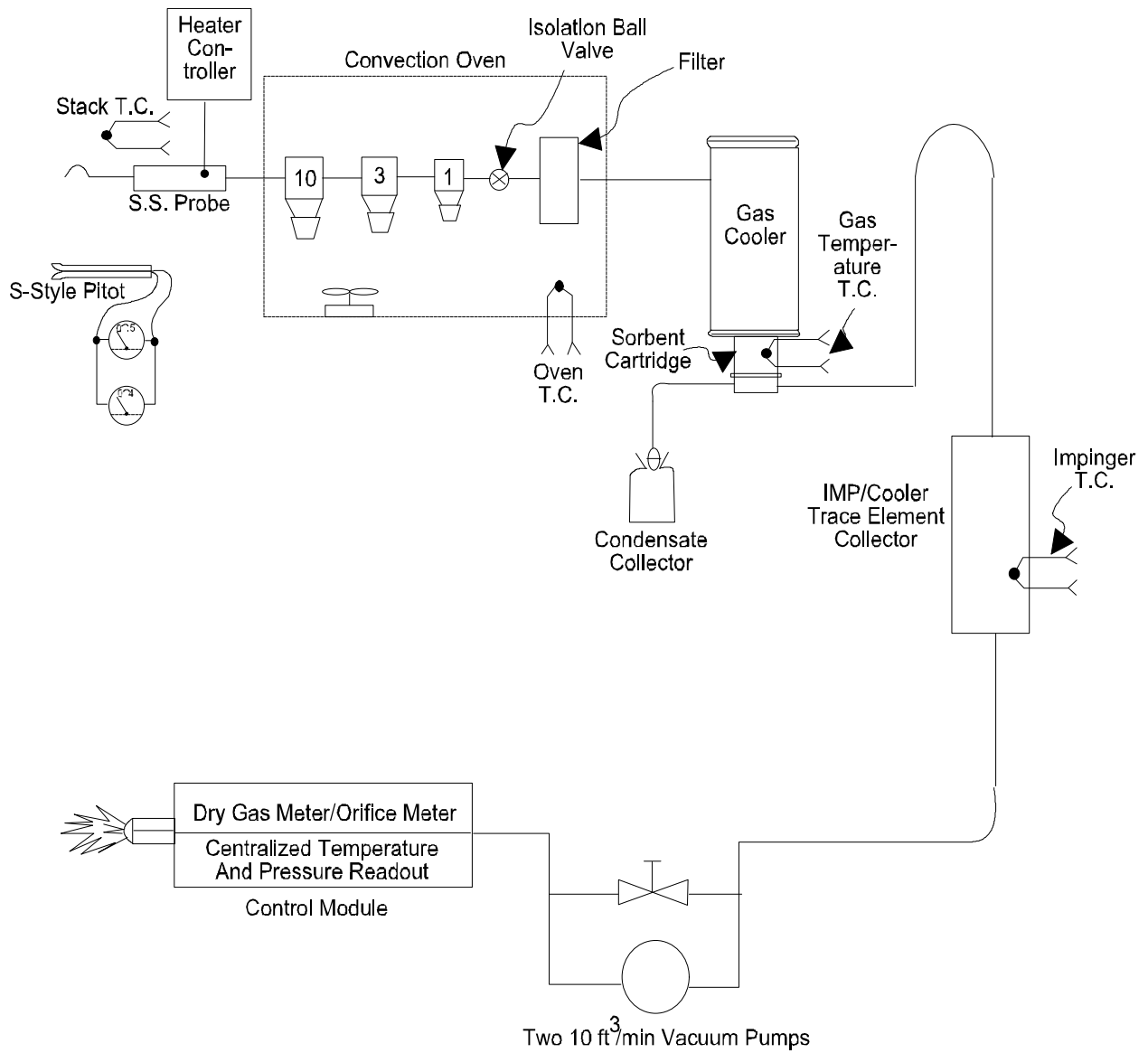

Figure 5-2. Schematic of a SASS Train

Source: References 102,103.

The general characteristics of the SASS and MM5 trains are compared in Table 5-1. The major differences between the two methods are in the sampling rate and volume of gas collected. The smaller gas volume used in the MM5 train (about 10 times smaller than the SASS train) requires less XAD-2<sup>®</sup> resin. Also, in a SASS train, the filter is normally held at a higher temperature than in the MM5 train.<sup>102,103</sup>

TABLE 5-1. COMPARISON OF MM5 AND SASS CHARACTERISTICS

Characteristics	MM5	SASS
Inert materials of construction	Yes	No
Percent isokineticity achievable	90 - 110	70 - 150 <sup>a</sup>
Typically used to traverse	Yes	No
Particle sizing of sample	No	Yes
Sample size over a 4-6 hour period (dscm)	3	30
Sampling flow rate (dscmm)	0.02 - 0.03	0.09 - 0.14

Source: References 103

<sup>a</sup> Assuming reasonably uniform, non-stratified flow.

In the MM5 sampling train, a water-cooled condenser and XAD-2<sup>®</sup> resin cartridge are placed immediately before the impinger section. XAD-2<sup>®</sup> is designed to adsorb a broad range of volatile organic species. The gas stream leaving the filter is cooled and conditioned in the condenser prior to entering the sorbent trap, which contains the XAD-2<sup>®</sup> resin. From the sorbent trap, the sample gas is routed through impingers, a pump, and a dry gas meter. The MM5 train is designed to operate at flow rates of approximately 0.015 dry standard cubic meters per minute (dscmm) or, equivalently, 0.5 dry standard cubic feet per minute (dscfm) over a 4-hour sampling period. Sample volumes of 3 dscm (100 dscf) are typical.<sup>103</sup>



An advantage of using the MM5 train is that it is constructed of inert materials. A disadvantage is that long sampling periods (2 hours) are required to collect sufficient sample for quantitative analysis.

The SASS train is a multi-component sampling system designed for collecting particulates, volatile organics, and trace metals. The train contains three heated cyclones and a heated filter that allow size fractionation of the particulate sample. Volatile organic material is collected in a sorbent trap containing XAD-2<sup>®</sup> resin. Volatile inorganic species are collected in a series of impingers before the sample gas exits the system through a pump and a dry gas meter. Large sample volumes are required to ensure adequate recovery of sample fractions. The system is designed to operate at a flow rate of 0.113 scmm (4.0 scfm), with typical sample volumes of 30 dscm (1,000 dscf).<sup>102</sup>

An advantage of the SASS train is that a large quantity of sample is collected. A disadvantage is that the system does not have the ability to traverse the stack. Also, because constant flow is required to ensure proper size fractionation, the SASS train is less amenable to compliance determinations because isokinetic conditions are not achieved. Another disadvantage is the potential of corrosion of the stainless steel components of the SASS train by acidic stack gases.<sup>11</sup>

Other methods that have been used to collect and determine concentrations of CDD and CDF from stationary sources are EPA Reference Method 23,<sup>104</sup> California Air Resources Board (CARB) Method 428,<sup>105</sup> and a draft ASME (American Society of Mechanical Engineers) protocol that was distributed in December 1984.<sup>106</sup>

EPA Reference Method 23 is a combined sampling and analytical method that uses a sampling train identical to the one described in EPA Method 5, with the exceptions and modifications specified in the method.<sup>104</sup>

CARB Method 428 is another combined sampling and analytical method. With Method 428, particulate and gaseous phase CDD and CDF are extracted isokinetically from a stack and collected on a filter, on XAD-2<sup>®</sup> resin, in impingers, or in upstream sampling train components. The sampling train in Method 428 is similar to the train in EPA Method 23 except that the CARB Method 428 train includes one impinger containing either water or ethylene glycol and the EPA Method 23 train includes two impingers containing water.

The draft ASME protocol assumes that all of the compounds of interest are collected either on XAD-2<sup>®</sup> resin or in upstream sampling train (MM5) components. The minimum detectable stack gas concentration should generally be in the nanogram/cubic meter (ng/m<sup>3</sup>) or lower range.

## 5.2 SAMPLE RECOVERY AND PREPARATION

Quantitative recovery of CDD and CDF requires the separation of these compounds from the remainder of the collected material, as well as efficient removal from the collection media. A technique commonly used for recovery of CDD and CDF from filters, and adsorbent and liquid media is soxhlet extraction.

Most recovery methods entail (1) the addition of isotopically labeled internal standards and/or surrogate compounds, (2) concentration of the sample volume to 1-5 mL or less, (3) sample cleanup involving a multi-column procedure, and (4) concentration of the sample to the final desired volume.

EPA Method 23, CARB Method 428, and the draft ASME protocol employ soxhlet extraction for the extraction of CDD and CDF from both filter and sorbent catches. The primary difference among these methods is in the recovery solvents used.

EPA Method 23 sample recovery solvent for rinsing the sample train glassware is acetone, with a final quality assurance rinse of toluene; however, the results from the toluene rinse are not used in calculating total CDD and CDF emissions. Toluene is used for soxhlet extraction. The columns used for sample cleanup include silica gel, modified silica gel, basic alumina, and carbon/celite.

In CARB 428, sample recovery solvents for rinsing the sample train glassware include methanol, benzene, methylene chloride and distilled deionized water. The filter and sorbent catches are dried with sodium sulfate ( $\text{Na}_2\text{SO}_4$ ) prior to soxhlet extraction with benzene or toluene. A minimum two-column cleanup system (silica gel/alumina) is required. A third column, the carbon/celite cleanup procedure, may be necessary.

The draft ASME protocol specifies the use of acetone followed by hexane as sample recovery solvents and toluene as the soxhlet extraction solvent. Silica and alumina column cleanup procedures are the minimum requirement, with cleanup on carbon/celite and silica/diol columns if necessary.

EPA Reference Methods 8280 and 8290 are analytical methods used to determine TCDD/TCDF through OCDD/OCDF in chemical wastes, including still bottoms, fuel oils, sludges, fly ash, reactor residues, soil, and water. Both methods involve the addition of internal standards to the sample prior to a matrix-specific extraction procedure as specified in the method. The extracts are submitted to an acid-base washing treatment and dried. Following a solvent exchange step, the residue is cleaned up by column chromatography on neutral alumina and carbon on celite.<sup>102,105</sup>

EPA Method 8280 employs seven  $^{13}\text{C}$  labeled standards and one  $^{37}\text{Cl}$  labeled standard. Two are used as recovery standards, five are used as internal standards, and one is used as a cleanup standard. There are no labeled standards for the PeCDD/PeCDF homologues, the HxCDF homologues, and the HpCDD homologues. This means that for these CDD/CDF

homologues, the efficiency of the extraction and cleanup procedures cannot be measured.<sup>107</sup> The method does not include the use of surrogate standards, which are normally added to the adsorbent trap, because Method 8280 is only an analytical method.

EPA Method 8290 employs eleven <sup>13</sup>C labeled standards. Two are used as recovery standards and nine are used as internal standards. TCDD/TCDF through HpCDD/HpCDF and OCDD are represented by the internal standards. This use of standards allows for monitoring of all but OCDF for extraction and cleanup recoveries.<sup>106,107</sup>

### 5.3 QUANTITATIVE ANALYSIS

The analytical techniques employed to identify and quantify CDD/CDF in environmental samples include high-resolution capillary column gas chromatography coupled with low-resolution mass spectrometry (HRGC/LRMS) or high-resolution mass spectrometry (HRGC/HRMS). EPA Method 8280 and the draft ASME protocol use HRGC/LRMS; EPA Method 23 and EPA Reference Method 8290 use HRGC/HRMS. Either technique can be used in CARB 428.

Separation of isomers or series of isomers is accomplished by HRGC, and quantification is accomplished by operating the mass spectrometer in the selected ion monitoring (SIM) mode. A high-resolution fused silica capillary column (60 m DB-5) is used to resolve as many CDD/CDF isomers as possible; however, no single column is known to resolve all isomers.

Identification is based on gas chromatograph retention time and correct chlorine isotope ratio. Strict identification criteria for CDD/CDF are listed in each individual method. Quantification generally involves relative response factors determined from multi-level calibration standards. An initial calibration curve is required prior to the analysis of any sample and then intermittent calibrations (i.e., analysis of a column performance-check solution and a mid-range concentration solution) are performed throughout sample analyses.

In the draft ASME protocol, two different columns are required if data on both 2,3,7,8-TCDD and 2,3,7,8-TCDF, as well as on total CDD/CDF by chlorinated class, are desired. The appropriate columns are a fused silica capillary column (60 m DB-5) and a 30 m capillary (DB-225). The DB-5 column is used to separate several groups of TCDD/TCDF through OCDD/OCDF. Although this column does not resolve all of the isomers within each chlorinated group, it effectively resolves each of the chlorinated groups from all of the other chlorinated groups, thereby providing data on the total concentration of each group (that is, total TCDD/TCDF through OCDD/OCDF). The DB-225 column is used to quantify 2,3,7,8-TCDF because it adequately resolves this isomer from the other TCDF isomers.<sup>106</sup>

The capillary gas chromatographic columns recommended in CARB Method 428 and EPA Method 23 include the 60 m DB-5 or the SP-2331. The peak areas for the two ions monitored by the mass spectrometer for each analyte are summed to yield the total response for each analyte. Each internal standard is used to quantify the CDD/CDF in its homologous series.

A DB-5 (30 m) or SP-2250 capillary column is recommended for EPA Methods 8280 and 8290. The analytical procedures specified in EPA Method 8290 are similar to those in Method 23, with the addition of the surrogate standards used to measure sample collection efficiency. Identification of the compounds for which an isotopically labeled standard is used is based on elution at the exact retention time established by analysis of standards and simultaneous detection of the two most abundant ions in the molecular ion region. Compounds for which no isotopically labeled standard is available are identified by their relative retention times, which must fall within the established retention windows, and the simultaneous detection of the two most abundant ions in the molecular ion region in the correct abundance ratio. The retention windows are established by analysis of a GC performance evaluation solution. Identification is confirmed by comparing the ratio of the integrated ion abundance of the molecular ion species to the theoretical abundance ratio.

Quantification of the individual homologues and total CDD/CDF is based upon a multi-point calibration curve for each homologue.<sup>107,108</sup> The major difference between Method 8280 and Method 8290 is the resolving power of the mass spectrometer. The HRMS provides a higher-quality analysis than does the LRMS because of its ability to incorporate additional labeled standards to cover almost all of the TCDD/TCDF through OCDD/OCDF homologues.

## SECTION 6.0

### REFERENCES

1. U.S. EPA. *Compilation of Air Pollutant Emission Factors*, 5th ed. (AP-42), Vol. I: Stationary Point and Area Sources. Research Triangle Park, North Carolina: U.S. Environmental Protection Agency, 1995.
2. U.S. EPA. *Technical Procedures for Developing AP-42 Emission Factors and Preparing AP-42 Sections*. EPA-454/B-93-050. Research Triangle Park, North Carolina: U.S. Environmental Protection Agency, Office of Air Quality Planning and Standards, 1993.
3. Pope, A. (U.S. Environmental Protection Agency, Emission Inventory Branch); R.B. Jones (Midwest Research Institute); and G. Brooks (Radian Corporation). Group discussion on applying "U" rating to emission factors. Research Triangle Park, North Carolina. December 8, 1992.
4. World Health Organization. Sources of Environmental Pollution. *Polychlorinated Dibenzo-p-dioxins and Dibenzofurans, Environmental Health Criteria 88*. Geneva, Switzerland: World Health Organization, 1989.
5. U.S. EPA. *Health and Environmental Effects Profile for Tetra-, Penta-, and Hexachlorodibenzofurans*. EPA-600/X-84/114. Cincinnati, Ohio: U.S. Environmental Protection Agency, Office of Health and Environmental Assessment, 1983. p. 1-1.
6. U.S. EPA. *Health Assessment Document for Polychlorinated Dibenzo-p-dioxins*. EPA-600/8-84-014A. Washington, D.C.: U.S. Environmental Protection Agency, Office of Health and Environmental Assessment, 1984. pp. 3-5.
7. Podoll, R.T., H.M. Jaber, and T. Mill. Tetrachlorodibenzodioxin: Rates of Volatilization and Photolysis in the Environment. *Environmental Science and Technology*. 20(1986):490.

8. Lustenhouwer, J.W.A., K. Olie, and O. Hutzinger. Chlorinated Dibenzo-p-dioxins and Related Compounds in Incinerator Effluents: A Review of Measurements and Mechanisms of Formation. *Chemosphere*. 9:512, 1990.
9. U.S. EPA. *National Dioxin Study Tier 4--Combustion Sources: Engineering Analysis Report*. EPA-450/4-84-014h. Research Triangle Park, North Carolina: U.S. Environmental Protection Agency, 1987.
10. U.S. EPA. *National Dioxin Study Tier 4--Combustion Sources: Project Summary Report*. EPA-450/4-84-014g. Research Triangle Park, North Carolina: U.S. Environmental Protection Agency, 1987.
11. Barnes, D.G., F.W. Kutz (U.S. Environmental Protection Agency, Office of Research and Development); D.P. Bottimore (Versar, Inc.). *Interim Procedures for Estimating Risks Associated with Exposures to Mixtures of Chlorinated Dibenzo-p-dioxins and Dibenzofurans (CDD and CDF) and 1989 Update*. EPA-625/3-89/016. Washington, D.C.: U.S. Environmental Protection Agency, 1989.
12. National Dioxin Emission Estimates from Municipal Waste Combustors. U.S. Environmental Protection Agency, Emission Standards Division, Office of Air Quality Planning and Standards, Research Triangle Park, North Carolina. June 1996. Docket A-90-45, Item VII-A-001.
13. National Dioxin Emission from Medical Waste Incinerators. U.S. Environmental Protection Agency, Emission Standards Division, Office of Air Quality Planning and Standards, Research Triangle Park, North Carolina. June 1996.
14. U.S. EPA. *Locating and Estimating Air Emissions from Sources of Polycyclic Organic Matter*, Final Report. Research Triangle Park, North Carolina: U.S. Environmental Protection Agency, November 1996.
15. Fenn, D.A., and K.L. Nebel (Radian Corporation). Memorandum to W.H. Stevenson (U.S. Environmental Protection Agency, Emission Standards Division) concerning MWC Database. March 1992.
16. AP-42, 5th ed., *op. cit.*, note 3. Section 2.1, Refuse Combustion, 1995.
17. U.S. EPA. *Municipal Waste Combustion Assessment: Technical Basis for Good Combustion Practice*. EPA-600/8-89-063. Research Triangle Park, North Carolina: U.S. Environmental Protection Agency, 1989.



18. U.S. EPA. *Locating and Estimating Air Toxics Emissions from Sewage Sludge Incinerators*. EPA-450/2-90-009. Research Triangle Park, North Carolina: U.S. Environmental Protection Agency, 1990.
19. U.S. EPA. Standards of Performance for New Stationary Sources: Municipal Waste Combustors, 59 FR 48216, September 20, 1994.
20. U.S. EPA. *Municipal Waste Combustors--Background Information for Proposed Standards: Post-Combustion Technology Performance*. EPA-450/3-89-27c. Research Triangle Park, North Carolina: U.S. Environmental Protection Agency, 1989.
21. U.S. EPA. *Locating and Estimating Air Toxic Emissions from Medical Waste Incinerators*. EPA-454/R-93-053. Research Triangle Park, North Carolina: U.S. Environmental Protection Agency, 1993.
22. AP-42, 5th ed., *op. cit.*, note 3. Section 2.3, Medical Waste Incineration, 1995.
23. Moody, T.K. (Radian Corporation), and R. Copland (U.S. Environmental Protection Agency, Emission Standards Division). Teleconference concerning hospital incinerators. July 17, 1995.
24. Radian Corporation. *Site 4 Final Emission Test Report, Sewage Sludge Test Program*. Research Triangle Park, North Carolina: U.S. Environmental Protection Agency, 1989.
25. ERT. *Non-Criteria Emissions Monitoring Program for the Envirotech Nine-Hearth Sewage Sludge Incinerator at the Metropolitan Wastewater Treatment Facility*. St. Paul, Minnesota: Metropolitan Waste Control Commission, 1986.
26. U.S. EPA. *National Dioxin Study Tier 4--Combustion Sources, Final Test Report--Site 1 Sewage Sludge Incinerator SSI-A*. EPA-450/4-84-014j. Research Triangle Park, North Carolina: U.S. Environmental Protection Agency, 1987.
27. U.S. EPA. *National Dioxin Study Tier 4--Combustion Sources, Final Test Report--Site 3 Sewage Sludge Incinerator SSI-B*. EPA-450/4-84-014l. Research Triangle Park, North Carolina: U.S. Environmental Protection Agency, 1987.
28. U.S. EPA. *National Dioxin Study Tier 4--Combustion Sources, Final Test Report--Site 12 Sewage Sludge Incinerator SSI-C*. EPA-450/4-84-014l. Research Triangle Park, North Carolina: U.S. Environmental Protection Agency, 1987.
29. Acurex Corporation. *1990 Source Test Data for the Sewage Sludge Incinerator*. Prepared for the Palo Alto Water Quality Control Plant. Palo Alto, California: Acurex Corporation, 1991.

30. Entropy Environmentalists, Inc. *Emissions of Metals, Chromium and Nickel Species, and Organics from Municipal Wastewater Sludge Incinerators*, Vol. I: Summary Report. Cincinnati, Ohio: U.S. Environmental Protection Agency, 1992.
31. AP-42, 5th ed., *op. cit.*, note 3. Section 2.2, Sewage Sludge Incineration, 1995.
32. Whitworth, W.E., and L.R. Waterland. *Pilot-Scale Incineration of PCB-Contaminated Sediments from the Hot Spot of the New Bedford Harbor Superfund Site*. Jefferson, Arkansas: Acurex Corporation, 1992.
33. Oppelt, E.T. Incineration of Hazardous Waste--A Critical Review. *Journal of Air Pollution Control Association*. 37(5):558-586, 1987.
34. Standards for Owners and Operators of Hazardous Waste Incinerators and Burning of Hazardous Wastes in Boilers and Industrial Furnaces. 40 CFR Parts 260, 261, 264, and 270. *Federal Register*. 55(82):17-93, April 27, 1990.
35. U.S. EPA. *Permit Writer's Guide to Test Burn Data, Hazardous Waste Incineration*. EPA-625/6-86-012. Cincinnati, Ohio: U.S. Environmental Protection Agency, 1986.
36. U.S. EPA. *National Dioxin Study Tier 4--Combustion Sources, Final Test Report--Site 2 Industrial Solid Waste Incinerator ISW-A*. EPA-450/4-84-014k. Research Triangle Park, North Carolina: U.S. Environmental Protection Agency, 1987.
37. Radian Corporation. *Summary of Trace Emissions from and Recommendations of Risk Assessment Methodologies for Coal and Oil Combustion Sources*. DCN No. 86-203-024-41-10. Research Triangle Park, North Carolina: U.S. Environmental Protection Agency, 1986.
38. Cole, J. (Research Triangle Institute). Memorandum to W. Maxwell (U.S. Environmental Protection Agency) on HAP Emission Factors. January 19, 1995.
39. Someshwar, A.V. and J.E. Pinkerton. *Air Pollution Engineering Manual*, Chapter 18: Wood Processing Industry. Air and Waste Management Association. New York, New York: Van Nostrand Reinhold, 1992.
40. AP-42, 5th ed., *op. cit.*, note 3. Section 1.6, Wood Waste Combustion Boilers, 1995.
41. Someshwar, A.V. Summary of Mill Test Reports on Wood Residue Combustion, Black Liquor Combustion, and Kraft Mill Sludge Burning. NCASI Files. Gainesville, Florida: National Council of the Paper Industry for Air and Stream Improvement, Inc., 1995.
42. AP-42, 5th ed., *op. cit.*, note 3. Section 1.10, Residential Wood Stoves, 1995.

43. Johnson, N.D., and M.T. Schultz (ORTECH Corporation). *MOE Toxic Chemical Emissions Inventory for Ontario and Eastern North America*. Final Report No. P92-T61-5429/OG. Rexdale, Ontario: Ontario Ministry of the Environment, Air Resources Branch, 1992.
44. AP-42, 5th ed., *op. cit.*, note 3. Section 1.9, Residential Fireplaces, 1995.
45. AP-42, 5th ed., *op. cit.*, note 3. Section 1.3, Fuel Oil Combustion, 1995.
46. U.S. EPA. *National Dioxin Study Tier 4--Combustion Sources: Final Test Report--Site 13 Residential Wood Stove WS-A*. EPA-450/4-84-014v. Research Triangle Park, North Carolina: U.S. Environmental Protection Agency, 1987.
47. U.S. EPA. *Estimating Exposure to Dioxin-Like Compounds*, Volume II: Properties, Sources, Occurrence, and Background Exposures, External Review Draft. EPA-600/6-88-005bC. Washington, D.C.: U.S. Environmental Protection Agency, Exposure Assessment Group, Office of Health and Environmental Assessment, June 1994.
48. U.S. EPA. *Markets for Scrap Tires*. EPA/530-SW-90-074A. Washington, D.C.: U.S. Environmental Protection Agency, Office of Solid Waste and Emergency Response, 1991.
49. Scrap Tire Management Council. *Scrap Tire Use/Disposal Study*, 1992 Update. 1992.
50. Radian Corporation. *Modesto Energy Company Waste Tire-to-Energy Facility, Westley, California*, Final Emission Test Report. Report No. 243-047-20. Research Triangle Park, North Carolina: Radian Corporation, 1988.
51. California Air Resources Board. *Emissions Testing of a Propane Fired Incinerator at a Crematorium*. Report No. ERC-39. Sacramento, California: California Air Resources Board, 1992.
52. Cremation Association of North America. *Cremation Statistics*. *Cremationist*. Chicago, Illinois: Cremation Association of North America, 1992.
53. U.S. EPA. *Emission Factors for Iron Foundries--Criterion and Toxic Pollutants*. EPA-60/2-90-044. Cincinnati, Ohio: U.S. Environmental Protection Agency, Control Technology Center, Office of Research and Development, 1990.
54. U.S. EPA. *Electric Arc Furnaces in Ferrous Foundries, Background Information for Proposed Standards*. Report No. 3-80-020a. Research Triangle Park, North Carolina: U.S. Environmental Protection Agency, Office of Air Quality Planning and Standards, 1980.

55. California Air Resources Board. *Emissions Measurement of Toxic Compounds from a Cupola Baghouse at a Steel Foundry*. Report No. ERC-61. Sacramento, California: California Air Resources Board, 1993.
56. Keller, P.A. (Radian Corporation). Teleconference with J. Maysilles, (U.S. Environmental Protection Agency). April 2, 1994.
57. AP-42, 5th ed., *op. cit.*, note 3. Section 12.9, Secondary Copper Smelting and Alloying, 1995.
58. U.S. EPA. *National Dioxin Study Tier 4--Combustion Sources: Final Test Report--Site 10 Secondary Copper Recovery Cupola Furnace MET-A*. EPA-450/4-84-0145. Research Triangle Park, North Carolina: U.S. Environmental Protection Agency, 1987.
59. AP-42, 5th ed., *op. cit.*, note 3. Section 12.8, Secondary Aluminum Operations, 1995.
60. California Air Resources Board. *Dioxin/Furan Emissions Estimates from a Secondary Aluminum Facility*. Report No. ERC-9. Sacramento, California: California Air Resources Board, 1992.
61. California Air Resources Board. *Emissions Measurements on Delacquering System*. Report No. ERC-32. Sacramento, California: California Air Resources Board, 1992.
62. U.S. EPA. *Secondary Lead Smelting Background Information Document For Proposed Standards*, Vol. 1. EPA-450/R-94-024a. Research Triangle Park, North Carolina: U.S. Environmental Protection Agency, Office of Air Quality Planning and Standards, 1994.
63. Steinwurtzel, R.N. (Counsel for Association of Battery Recyclers), and D.W. Safreit (U.S. Environmental Protection Agency, Emission Factor and Inventory Group). Personal communication. May 4, 1995.
64. U.S. EPA. *HAP Emission Testing on Selected Sources at a Secondary Lead Smelter--Tejas Resources, Inc.*, Draft Emission Test Report. Prepared by Roy F. Weston, Inc. EPA Contract No. 68-D1-0104. Research Triangle Park: U.S. Environmental Protection Agency, 1992.
65. U.S. EPA. *HAP Emission Testing on Selected Sources at a Secondary Lead Smelter--Schuylkill Metals Corporation*, Draft Emission Test Report. Prepared by Roy F. Weston, Inc. EPA Contract No. 68-D1-0104. Research Triangle Park: U.S. Environmental Protection Agency, 1992.

66. U.S. EPA. *HAP Emission Testing on Selected Sources at a Secondary Lead Smelter--East Penn Manufacturing Company*, Draft Emission Test Report. Prepared by Roy F. Weston, Inc. EPA Contract No. 68-D1-0104. Research Triangle Park: U.S. Environmental Protection Agency, 1992.
67. U.S. EPA. *Secondary Lead Smelting Background Information Document For Proposed Standards*, Vol. 2: Appendices. EPA-450/R-94-024b. Research Triangle Park, North Carolina: U.S. Environmental Protection Agency, Office of Air Quality Planning and Standards, 1994.
68. U.S. EPA. *National Dioxin Study Tier 4--Combustion Sources: Final Test Report--Site 6 Wire Reclamation Incinerator WRI-A*. EPA-450/4-84-0140. Research Triangle Park, North Carolina: U.S. Environmental Protection Agency, 1987.
69. U.S. EPA. *National Dioxin Study Tier 4--Combustion Sources: Final Test Report--Site 11 Drum and Barrel Reclamation Furnace DBR-A*. EPA-450/4-8-0144. Research Triangle Park, North Carolina: U.S. Environmental Protection Agency, 1987.
70. AP-42, 5th ed., *op. cit.*, note 3. Section 10.2, Chemical Wood Pulping, 1995.
71. Dyer, H., S. Gajita, and D. Fisher. *1992 Lockwood-Post's Directory of the Pulp, Paper and Allied Trades*. Miller Freeman Publications. San Francisco, California, 1991.
72. Dyer, H., S. Gajita, and D. Fisher. *1997 Lockwood-Post's Directory of the Pulp, Paper and Allied Trades*. Miller Freeman Publications. San Francisco, California, 1997.
73. National Council of the Paper Industry for Air and Stream Improvement, Inc. *A Study of Kraft Recovery Furnace Hydrochloric Acid Emissions*. Technical Bulletin No. 674. Gainesville, Florida: National Council of the Paper Industry for Air and Stream Improvement, Inc., August, 1994.
74. Carruth, G., ed. *The Volume Library*, Energy and Power Sources. Nashville, Tennessee: The Southwestern Company, 1986.
75. Ballschmiter, K., et al. Automobile Exhausts Versus Municipal Waste Incineration as Sources of the Polychloro-dibenzodioxins (PCDD) and -furans (PCDF) Found in the Environment. *Chemosphere*. 15(7):901-915, 1986.
76. Marklund, S., C. Rappe, M. Tysklind, and K. Egeback. Identification of Polychlorinated Dibenzofurans and Dioxins in Exhausts from Cars Run on Leaded Gasoline. *Chemosphere*. 16(1):29-36, 1987.

77. Marklund, S., et al. Emissions of PCDDs and PCDFs in Gasoline and Diesel Fueled Cars. *Chemosphere*. 20(5):553-561, 1990.
78. Oehme, M., S. Larson, and E.M. Bvevik. Emission Factors of PCDD and PCDF for Road Vehicles Obtained by Tunnel Experiment. *Chemosphere*. 23(11/12):1699-1708, 1991.
79. U.S. Environmental Protection Agency. *Emissions Inventory of Section 112(c)(6) Pollutants: Polycyclic Organic Matter (POM), 2,3,7,8-Tetrachlorodibenzo-P-Dioxin (TCDD)/2,3,7,8-Tetrachlorodibenzofuran (TCDF), Polychlorinated Biphenyl Compounds (PCBs), Hexachlorobenzene, Mercury, and Alkylated Lead*. Draft Report. Office of Air Quality Planning and Standards, Research Triangle Park, North Carolina, 1996.
80. Humer, C. Activated Carbon Plant Starts for American Novit. *Chemical Marketing Reporter*. June 8, 1992. p. 2.
81. U.S. EPA. *National Dioxin Study, Tier 4--Combustion Sources, Final Test Report-- Site 9, Carbon Regeneration Furnace CRF-A*. EPA-450/4-84-014r. Research Triangle Park, North Carolina: U.S. Environmental Protection Agency, Office of Air Quality Planning and Standards, 1987.
82. Schuliger, W.G. and L.G. Knapil. *Reactivation Systems*. Paper presented at the annual conference of the American Water Works Association, June 1990.
83. Byers, W.D. Charcoal/Activated Carbon. *Air Pollution Engineering Manual*. A.J. Buonicore and W.J. Davis, eds. New York, New York: Van Nostrand Reinhold, 1991.
84. Koffskey, W.E. and B.W. Lykins, Jr. GAC Adsorption and Infrared Reactivation: Case Study. *Journal of American Water Works Association*. (January 1990) 48-56.
85. BTC Environmental, Inc. *AB-2588 Toxic Emission Testing*. Ventura, CA: Orange County Water District, 1991.
86. Raven, P.H. *Biology of Plants*. New York, New York: Worth Publishers, Inc., 1980.
87. Bacher, R., M. Swerev, and K. Ballschmiter. Profile and Pattern of Monochloro- through Octachlorodibenzodioxins and -dibenzofurans in Chimney Deposits from Wood Burning. *Environmental Science and Technology*. 26(8):1649-1655, 1992.
88. Nestruck, T.J., and L.L. Lamparski. Assessment of Chlorinated Dibenzo-p-dioxin Formation and Potential Emission to the Environment from Wood Combustion. *Chemosphere*. 12(4/5):617-626, 1983.

89. Tashiro, C. et al. Preliminary Report: Dioxins and Furans in Prescribed Burns. *Chemosphere*. 20:1533-1536, 1990.
90. U.S. Code of Federal Regulations. Title 40, Protection of the Environment, Part 761-- Polychlorinated Bi-phenyls (PCBs) Manufacturing, Processing, Distribution in Commerce, and Use Prohibitions. Washington, D.C.: U.S. Government Printing Office, 1994.
91. U.S. EPA. *National Dioxin Study Tier 4--Combustion Sources: Final Literature Review*. EPA-450/4-84-014i. Research Triangle Park, North Carolina: U.S. Environmental Protection Agency, 1986.
92. AP-42, 5th ed., *op. cit.*, note 3. Section 2.4, Landfills, 1995.
93. California Air Resources Board. *Compliance Testing for Non-Criteria Pollutants at a Landfill Flare*. Report No. ERC-2. Sacramento, California: California Air Resources Board, 1990.
94. Lee, A. et al. *Dioxins and Furan Contamination in the Manufacture of Halogenated Organic Chemicals*. EPA/600/2-86/101. Cincinnati, Ohio: U.S. Environmental Protection Agency, 1986.
95. Sittig, M. *Handbook of Toxic and Hazardous Chemicals and Carcinogens*, 2nd ed. Park Ridge, New Jersey: Noyor Publications, 1985.
96. Wilkinson, J. (Vulcan Chemicals). Letter to D. Safriet (U.S. Environmental Protection Agency, Emission Factor and Inventory Group) concerning dioxin exposure assessment comments, technical information staff. June 20, 1995.
97. Chinkin, L. et al. *Inventory of Chlorophenol Use in the Forest Products Industry and Investigation of Related Emissions of Chlorinated Dibenzodioxins and Dibenzofurans*. SYSAPP-87/078. Sacramento, California: California Air Resources Board, 1987.
98. AP-42, 5th ed., *op. cit.*, note 3. Section 11.6, Portland Cement Manufacturing, 1995.
99. Pierson, T. (Research Triangle Institute). *Summary of Portland Cement MACT Data*. Report to T. Lahre, (U.S. Environmental Protection Agency, Office of Air Quality Planning and Standards). Research Triangle Park, North Carolina: Research Triangle Institute, April 25, 1994.
100. Kim, I. Incinerators and Cement Kilns Face Off. *Chemical Engineering*. April 1994.

101. U.S. EPA. *Technical Support for Revision of the Hazardous Waste Combustion Regulations for Cement Kilns and Other Thermal Treatment Devices*, Second Draft. Prepared by Energy and Environmental Research Corporation, Irvine, California. Washington, D.C.: U.S. Environmental Protection Agency, Office of Solid Waste. May 17, 1994.
102. U.S. EPA. *IERL-RTP Procedure Manual: Level 1 Environmental Assessment* (2nd ed.). EPA-600/7-78-201. Interagency Energy/Environment R&D Program Report. U.S. Environmental Protection Agency, October 1978.
103. Cooke, M., F. DeRoos, and B. Rising. *Hot Flue Gas Spiking and Recovery Study for Tetrachlorodibenzodioxins (TCDD) Using Modified Method 5 and SASS (Source Assessment Sampling System) Sampling with a Simulated Incinerator*. EPA-600/2-84/159. Research Triangle Park, North Carolina: U.S. Environmental Protection Agency, Industrial Environmental Research Laboratory, 1984.
104. Standards of Performance for New Stationary Sources, Appendix A, Test Method 23 - Determination of Polychlorinated Dibenzo-p-Dioxins and Polychlorinated Dibenzofurans from Stationary Sources. *Federal Register*, 60(104)28378-28426, May 31, 1995.
105. California Air Resources Board. *Stationary Source Test Methods*, Volume III: Methods for Determining Emissions of Toxic Air Contaminants from Stationary Sources. Sacramento, California: California Air Resources Board, Monitoring and Laboratory Division, 1989.
106. American Society of Mechanical Engineers. *Analytical Procedures to Assay Stack Effluent Samples and Residual Combustion Products for Polychlorinated Dibenzo-p-Dioxins (PCDD) and Polychlorinated Dibenzofurans (PCDF)*. Washington, D.C.: U.S. Department of Energy and U.S. Environmental Protection Agency, 1984.
107. U.S. EPA. *Test Methods for Evaluating Solid Waste*, 3rd ed. Method 8280 - The Analysis of Polychlorinated Dibenzo-p-Dioxin and Polychlorinated Dibenzofurans. SW-846. Washington, D.C.: Office of Solid Waste, 1986.
108. U.S. EPA. *Test Methods for Evaluating Solid Waste*, 3rd ed. Method 8290 - The Analysis of Polychlorinated Dibenzo-p-Dioxin and Polychlorinated Dibenzofurans by High-Resolution Gas Chromatography/High-Resolution Mass Spectrometry. SW-846. Washington, D.C.: Office of Solid Waste, 1986.



## APPENDIX A

### METHODS FOR ESTIMATING NATIONAL CDD/CDF EMISSIONS

Note: The national emissions estimates presented here are those that were available at the time this document was published. Ongoing efforts and studies by the U.S. Environmental Protection Agency will most likely generate new estimates. The reader should contact the U.S. Environmental Protection Agency for the most recent estimates.

## TABLE OF CONTENTS

Municipal Waste Combustion .....	A-1
Medical Waste Incineration .....	A-14
Sewage Sludge Incineration .....	A-20
Hazardous Waste Incineration .....	A-21
Lightweight Aggregate Kilns (LWAKS) .....	A-23
Portland Cement .....	A-24
Waste Tire Incineration .....	A-26
Utility Coal Combustion .....	A-27
Utility Residual Oil Combustion .....	A-28
Industrial Wood Combustion .....	A-29
Residential Coal Combustion .....	A-31
Residential Distillate Fuel Oil Combustion .....	A-34
Residential Wood Combustion .....	A-36
Iron and Steel Foundries .....	A-38
Secondary Copper Smelters .....	A-40
Secondary Lead Smelters .....	A-41
Secondary Aluminum Smelters .....	A-43
Drum and Barrel Reclamation/Incineration .....	A-45
On-road Mobile Sources .....	A-46
Pulp and Paper--Kraft Recovery Furnaces .....	A-48

TABLE OF CONTENTS (Continued)

Wood Treatment ..... A-49

Carbon Regeneration/Reactivation ..... A-50

Forest Fires ..... A-52

Crematories ..... A-53

Remaining Source Categories ..... A-54

References ..... A-55

## MUNICIPAL WASTE COMBUSTION

### Basis for Calculation

The national dioxin/furan emissions estimates for MWCs were obtained directly from work done by EPA's Emission Standards Division (ESD) to support MACT standards for this source category.<sup>1</sup> The estimates are based on dioxin data collected by the EPA during its "MWC Survey" in 1994. The dioxin emissions data that were collected were combined with MWC plant design data, plant annual utilization rate data, and flue gas flow rate conversion factors to calculate annual dioxin emission estimates. ESD calculated estimates for three different time periods (1993, 1995, and 2000), and the 1995 estimate is presented in this document because it is the most recent estimate. A summary of the methods used to determine the estimates are provided here. More detailed information on the derivation of the estimates can be obtained from the cited reference 1.<sup>1</sup>

There are three main types of municipal waste incinerators in the United States: mass burn (MB), refuse derived fuel (RDF), and modular combustors (MOD). Mass burn combustors are the most common type of combustor, representing 54 percent of all municipal waste combustors (MWCs) in the United States, followed by modular facilities (32 percent) and RDF facilities (13 percent).<sup>2</sup>

According to the 1994 Maximum Achievable Control Technologies (MACT) Study there are 158 existing MWC facilities with design capacities above 38.6 tons/day. The facilities designed to burn less than 38.6 tons/day account for less than one percent of the total waste flow to MWC facilities.<sup>2</sup> Of the total MWC capacity in the United States, about 58 percent of municipal waste is treated in mass burn facilities, 29 percent in RDF-fired facilities, 9 percent in modular combustors, and 4 percent in other MWC designs.<sup>2</sup>

Dioxin test results for 1993 were compiled from emission source tests performed between 1985 and 1993 (see Table A-1). In a limited number of cases, test results from 1994 on individual units were used if there were no changes in MWC unit operation or air pollution control device (APCD) configurations since 1993. Where the emission test date in the table is noted as 1985 through 1989, the data were gathered by OAQPS to develop the new source performance standards and emissions guidelines proposed for MWCs in 1989 (December 1989). Where the emission test date is noted as 1990 through 1994, the data were gathered by OAQPS, or submitted to OAQPS, as part of one of the following efforts:

1. Data gathered by OAQPS to develop the revised new source performance standards and emission guidelines for MWCs proposed on September 20, 1994;
2. Data submitted to OAQPS in response to the "MWC Survey" of dioxin emissions; or
3. Data submitted to the docket (A-90-45) as public comments on the revised new source performance standards and emission guidelines proposed on September 20, 1994.

For facilities with dioxin test data, the following criteria were used to determine the most representative test results for each facility for 1993:

- For facilities with more than one test result, the most recent test was used. These results were chosen such that they were representative of plant operation at the end of 1993. Exceptions to this were in cases when two or more tests were conducted at a MWC over a relatively short period of time. Then, the average of these tests was used to represent the 1993 emissions.
- At facilities with multiple units where not all units were tested, an average of the test results from the tested units was used as a representative value for the untested units.

Test results were obtained for approximately 55 percent of the domestic MWCs. For the other 45 percent, a set of default values was created and used to estimate dioxin concentrations. The set of default values was compiled from test data, AP-42 emission factors, and from the EPA

**Table A-1**

**Test Data Used for 1993 National Dioxin Estimates for MWCs**

Region	Unit Name	State	Total Plant Capacity (tpd)	Number of Combustors	Combustor Type	Air Pollution Control Devices	Combustor Number	Combustor Capacity (tpd)	Dioxin/Furans (ng/dscm @ 7% O <sub>2</sub> )		
									Total	TEQ <sup>a</sup>	Year
4	Huntsville Refuse-Fired Steam Fac.	AL	690	2	MB/WW	FF/SD	2	345	3	0.080	1990
9	Commerce Refuse-to-Energy Fac.	CA	380	1	MB/WW	FF/SD SNCR	1	380	10	NA	1998
9	Long Beach (SERRF)	CA	1380	3	MW/WW	FF/SD SNCR	1	460	4	NA	1988
9	Stanislaus (Modesto)	CA	800	2	MB/WW	FF/SD SNCR	1	400	32	NA	1993
							2	400	9	NA	1993
1	Bristol RRF	CT	650	2	MB/WW	FF/SD	1	325	75	1.670	1990
							2	325	8	0.140	1990
1	Mid-Connecticut Project	CT	2000	3	RDF	FF/SD	1	667	1	NA	1988
1	Wallingford RRF	CT	420	3	MOD/EA	FF/SD	1	140	178	NA	1991
							2	140	50	NA	1991
							3	140	47	NA	1991
4	Dade Co. RRF	FL	3000	4	RDF	ESP	1	750	449	NA	1990
4	Hillsborough Co. RRF	FL	1200	3	MB/WW	ESP	1	400	178	NA	1994
4	McKay Bay REF	FL	1000	4	MB/WW	ESP	1	250	8533	265.000	1994
							3	250	893	21.000	1994
							4	250	2160	49.000	1994
4	Pasco Co. Solid Waste RRF	FL	1050	3	MB/WW	FF/SD	1	350	11	0.190	1994
4	Wheelabrator Pinellas RRF	FL	3000	3	MB/WW	ESP	3	1000	3400 <sup>b</sup>	71.800	1994
10	Honolulu Resource Recovery Venture	HI	2160	2	RDF	ESP/SD	1	1080	10	NA	1990
							2	1080	3	NA	1990

**Table A-1**

**Test Data Used for 1993 National Dioxin Estimates for MWCs (Continued)**

Region	Unit Name	State	Total Plant Capacity (tpd)	Number of Combustors	Combustor Type	Air Pollution Control Devices	Combustor Number	Combustor Capacity (tpd)	Dioxin/Furans (ng/dscm @ 7% O <sub>2</sub> )		
									Total	TEQ <sup>a</sup>	Year
10	Waipahu Incinerator	HI	600	2	MB/REF	ESP	1	300	5690	NA	1994
5	Northwest WTE	IL	1600	4	MB/WW	ESP	2	400	65	NA	1993
5	Indianapolis RRF	IN	2362	3	MB/WW	FF/SD	2	787	12	0.120	1989
							3	787	1	0.010	1993
1	Haverhill Lawrence RDF	MA	710	1	RDF	ESP/FSI	1	710	136	NA	1992
1	North Andover RESCO	MA	1500	2	MB/WW	ESP/FSI	1	750	53	NA	1989
1	SEMASS RRF	MA	2700	3	RDF	ESP/SD	1	900	9	NA	1989
							2	900	12	NA	1989
1	Wheelabrator Millbury	MA	1500	2	MB/WW	ESP/SD	2	750	59	NA	1988
3	Hartford Co. WTE Fac.	MD	360	4	MOD/SA	ESP	1	90	300	5.580	1993
3	Pulaski	MD	1500	5	MB/REF	ESP	1	300	3313	37.000	1993
							2	300	3313	37.000	1993
							3	300	5894	85.200	1993
							4	300	5894	85.200	1993
							5	300	9045	104.000	1993
3	Southwest RRF (RESCO)	MD	2250	3	MB/WW	ESP	1	750	142	3.410	1993
							2	750	102	2.380	1993
							3	750	199	NA	1993
1	Greater Portland Region RRF	ME	500	2	MB/WW	ESP/SD	1	250	173	NA	1987
1	Maine Energy Recovery (Biddeford)	ME	600	2	RDF	FF/SD	1	300	4	NA	1987
1	Penobscot Energy Recovery Comp.	ME	700	2	RDF	ESP	1	350	2	NA	1988
5	Central Wayne Co. Sanitation Auth.	MI	500	2	RDF	ESP	1	250	383	12.200	1994
5	Clinton Township	MI	600	2	MB/REF	ESP	1	300	3254	55.800	1994

A-4



**Table A-1**

**Test Data Used for 1993 National Dioxin Estimates for MWCs (Continued)**

Region	Unit Name	State	Total Plant Capacity (tpd)	Number of Combustors	Combustor Type	Air Pollution Control Devices	Combustor Number	Combustor Capacity (tpd)	Dioxin/Furans (ng/dscm @ 7% O <sub>2</sub> )		
									Total	TEQ <sup>a</sup>	Year
5	Greater Detroit RRF	MI	3300	3	RDF	ESP	1	1100	2851	NA	1993
						FF/SD	2	1100	2	NA	1994
5	Kent Co. WTE Fac.	MI	625	2	MB/WW	FF/SD	1	312	5	0.090	1992
							2	312	12	0.310	1992
5	Hennepin Energy Recovery Facility	MN	1200	2	MB/WW	FF/SD SNCR/CI	1	600	1	0.030	1992
							2	600	2	0.020	1992
5	Olmstead WTE Facility	MN	200	2	MB/WW	ESP	1	100	219	NA	1994
5	Perham Renewable RF	MN	114	2	MOD/SA	ESP	1	57	35	NA	1994
5	Polk Co. Solid Waste Resource Recovery	MN	80	2	MOD/SA	ESP	1	40	269	8.990	1988
5	Pope-Douglas Solid Waste	MN	72	2	MOD/SA	ESP	2	36	446	7.440	1989
5	Ramsey-Washington	MN	720	2	RDF	ESP	2	360	31	NA	1988
5	Red Wing Solid Waste Boiler Facility	MN	72	2	MOD/EA	ESP	1	36	489	13.300	1990
5	Western Lake Superior Sanit. Distr. (Duluth)	MN	260	2	RDF	VS	2	130	16	NA	1992
5	Wilmarth Plant (Mankato)	MN	720	2	RDF	FF/SD	1	360	2	NA	1988
4	University City RRF	NC	235	2	MB/WW	ESP	2	118	579	NA	1994
1	SES Claremont RRF	NH	200	2	MB/WW	FF/DSI	1	100	38	NA	1987
							2	100	32	NA	1987
2	Camden RRF	NJ	1050	3	MB/WW	ESP/SD	1	350	75	NA	1992
2	Warren Energy RF	NJ	400	2	MB/WW	FF/SD	1	200	8	0.180	1988
2	Adirondack RRF	NY	432	2	MB/WW	ESP/SD	1	216	28	NA	1992
							2	216	40	NA	1992

A-5

**Table A-1**

**Test Data Used for 1993 National Dioxin Estimates for MWCs (Continued)**

Region	Unit Name	State	Total Plant Capacity (tpd)	Number of Combustors	Combustor Type	Air Pollution Control Devices	Combustor Number	Combustor Capacity (tpd)	Dioxin/Furans (ng/dscm @ 7% O <sub>2</sub> )		
									Total	TEQ <sup>a</sup>	Year
2	Babylon RRF	NY	750	2	MB/WW	FF/SD	1	375	1	NA	1991
2	Babylon RRF	NY	750	2	MB/WW	FF/SD	2	375	1	NA	1993
2	Dutchess Co. RRF	NY	400	2	MB/RC	FF/DSI	1	200	5	NA	1989
							2	200	18	NA	1989
2	Hempstead	NY	2505	3	MB/WW	FF/SD	2	835	1	0.010	1993
2	Huntington RRF	NY	750	3	MB	FF/SD SNCR	1	250	12	0.340	1993
							2	250	7	0.170	1993
							3	250	7	0.180	1993
2	Long Beach RRF	NY	200	1	MB/WW	ESP	1	200	709	13.700	1992
2	MacArthur WTE	NY	518	2	MB/RC	FF/DSI	1	259	4	NA	1993
							2	259	1	NA	1993
2	Niagara Falls RDF WTE	NY	2200	2	RDF	ESP	1	1100	1217	NA	1989
2	Oneida Co. ERF	NY	200	4	MOD/SA	ESP	1	50	462	NA	1985
2	Oswego Co. WTE	NY	200	4	MPD/SA	ESP	1	50	386	NA	1986
2	Westchester RESCO	NY	2250	3	MB/WW	ESP	1	750	183	NA	1993
5	Akron Recycle Energy System	OH	1000	3	RDF	ESP	1	333	370 <sup>c</sup>	NA	1994
							2	333	370 <sup>c</sup>	NA	1994
5	City of Columbus SW Reduction Fac.	OH	2000	6	RDF	ESP	6	333	12998	NA	1992
5	Montgomery Co. North RRF	OH	900	3	MB/RC/REF	ESP	1	300	5500 <sup>d</sup>	NA	1989
							2	300	5500 <sup>d</sup>	NA	1989
							3	300	8097	148.000	1994

A-6

**Table A-1**

**Test Data Used for 1993 National Dioxin Estimates for MWCs (Continued)**

Region	Unit Name	State	Total Plant Capacity (tpd)	Number of Combustors	Combustor Type	Air Pollution Control Devices	Combustor Number	Combustor Capacity (tpd)	Dioxin/Furans (ng/dscm @ 7% O <sub>2</sub> )		
									Total	TEQ <sup>a</sup>	Year
5	Montgomery Co. South RRF	OH	900	3	MB/RC/REF	ESP	1	300	5500 <sup>d</sup>	NA	1989
							2	300	5500 <sup>d</sup>	NA	1989
							3	300	5500 <sup>d</sup>	NA	1989
6	Walter B. Hall RRF	OK	1125	3	MB/WW	ESP	1	375	34	NA	1986
							2	375	49	NA	1987
10	Marion Co. WTE	OR	550	2	MB/WW	FF/SD	1	275	1	NA	1991
							2	275	4	NA	1991
3	Delaware Co. RRF	PA	2688	6	MB/RC/WW	FF/SD	1	448	2	NA	1992
							2	448	4	NA	1992
							3	448	10	NA	1991
							4	448	11	NA	1992
							5	448	4	NA	1991
							6	448	10	NA	1991
3	Harrisburg WTE	PA	720	2	MB/WW	ESP	2	360	1156	27.400	1994
3	Lancaster Co. RRF	PA	1200	3	MB/WW	FF/SD	1	400	114	2.380	1993
							2	400	61	1.470	1993
							3	400	49	1.300	1993
3	York Co. RR Center	PA	1344	3	MB/RC/WW	FF/SD	1	448	5	NA	1993
							2	448	8	NA	1993
							3	448	8	NA	1993
4	Foster Wheeler Charleston RR	SC	600	2	MB/WW	ESP/SD	2	300	44	NA	1990
4	Nashville Thermal Transfer Corp.	TN	1050	3	MB/WW	ESP	3	350	143	NA	1994

A-7

**Table A-1**

**Test Data Used for 1993 National Dioxin Estimates for MWCs (Continued)**

Region	Unit Name	State	Total Plant Capacity (tpd)	Number of Combustors	Combustor Type	Air Pollution Control Devices	Combustor Number	Combustor Capacity (tpd)	Dioxin/Furans (ng/dscm @ 7% O <sub>2</sub> )		
									Total	TEQ <sup>a</sup>	Year
3	Alexandria/Arlington RRF	VA	975	3	MB/WW	ESP/DSI CI	1	325	14 <sup>e</sup>	NA	1987
							3	325	18 <sup>e</sup>	NA	1993
3	Hampton (NASA) Refuse-fired Steam Gen.	VA	200	2	MB/WW	ESP	1	100	102	2.520	1992
3	Harrisonburg RRF	VA	100	2	MB/WW	ESP	1	50	8459	115.000	1994
3	I-95 Energy RRF (Fairfax)	VA	3000	4	MB/WW	FF/SD	1	750	9	0.230	1993
							2	750	6	0.170	1993
							3	750	8	0.200	1993
							4	750	7	0.150	1993
3	Norfolk Navy Yard	VA	2000	4	RDF	ESP	1	500	21129	429.000	1993
							2	500	32237	595.000	1993
							3	500	42955	1500.000	1994
							4	500	26360	800.000	1993
5	LaCrosse Co.	WI	400	2	RDF/FB	DSI/EGB	1	200	63	NA	1993
5	St. Croix Co. WTE Fac.	WI	115	3	MOD/SA		1	38	8	NA	1988

<sup>a</sup> Dioxin concentrations are listed both in units of ng/dscm total mass and ng/dscm TEQ where both were available. The TEQ concentration data were used for TEQ emissions calculations where TEQ data were available, and where TEQ data were not available a conversion ratio of 50:1 (total:TEQ) was used to convert the total mass data to TEQ.

<sup>b</sup> Pinellas data are average of three separate tests done during one year.

<sup>c</sup> Akron data were from 1994 test, and assumed to be representative of Akron pre-1994. MWC Survey discussion indicates that high ESP temperature was reported.

<sup>d</sup> Montgomery North/South data (except for Unit No. 3 at North) are an average value determined based on numerous tests.

<sup>e</sup> Alexandria data in MWC survey were from a test run without carbon injection. Since the unit has carbon injection, an additional reduction of 75% was assumed.

NA = Data not available

document EPA-450/3-89-27e "Municipal Waste Combustors - Background Information for Proposed Guidelines for Existing Facilities"<sup>3</sup> (this document presented the results of a study on APCD retrofits on MWC units). Default values were generated for every MWC combustor type and APCD configuration for which a default value was needed. Test data available to OAQPS, as of January 15, 1995, were organized into groups based on MWC combustor type and APCD configurations and averaged. These averages were designated as the default values for the corresponding combustor/APCD configurations. For the combustor/APCD configurations where there were no test data available, default values were obtained from the MWC section in AP-42,<sup>4</sup> or from EPA document EPA-450/3-89-27e. A summary of the default values is given in Table A-2.

To estimate annual emissions, a capacity factor for each unit is needed. This factor represents the percentage of operational time a plant has operated during one year. By using the capacity factor and unit capacity, the annual throughput (combustion) of MSW or RDF can be calculated. Some facilities provided data to OAQPS on the tonnage of municipal waste burned in year 1993. For these facilities, a capacity factor was estimated by dividing the tonnage burned in one year by the unit's rated yearly capacity and was used for the 1993 emissions calculation. For most units, however, the capacity factors used were default values taken from EPA document EPA-450/3-89-27e. For all units except modular/starved-air combustors, the default capacity factor was 91 percent (0.91). For modular/starved-air units, the default capacity factor was 74 percent (0.74).

For many test results and for all dioxin default concentrations, TEQ concentrations were not available. Similar to the development of the default dioxin concentrations, a default total mass-to-TEQ ratio was also developed. Test results from units for which there were both total mass and TEQ results available were used to develop a default ratio of total dioxin concentration to TEQ concentration. The total:TEQ ratios from these units were averaged, resulting in a default ratio of

**Table A-2**

**Default Dioxin/Furan Emission Levels  
From MWC Configurations<sup>a</sup>**

Combustor Type	APCD Type	Average Dioxin Value (ng/dscm @ 7% O <sub>2</sub> , total mass)
MB/WW	ESP*	222
	DSI/ESP	60
	DSI/FF	35
	SD/ESP	70
	SD/FF	16
RDF (all except FB)	ESP*	240
	DSI/FF	17
	SD/ESP	9
	SD/FF	8
RDF/FB	DSI/EGB	63
MB/RC/WW	ESP*	400
	DSI/ESP	100
	DSI/FF	7
	SD/ESP	40
	SD/FF	5
MB/REF	ESP*	500
	DSI/ESP	57
	DSI/FF	17
	SD/ESP	40
	SD/FF	5
MOD/SA	Uncontrolled	300
	ESP*	288
	DSI/ESP	98
	DSI/FF	8
	SD/ESP	40
	SD/FF	5
MOD/EA	Uncontrolled	200
	ESP*	468
	DSI/ESP	50
	DSI/FF	8
	SD/FF	92

<sup>a</sup> Values presented in this table are averages of available data for various combustor type/APCD type combinations. Values were estimated based on a compilation of the MWC survey data, background information for the 1991 and 1994 MWC rulemakings, public comments received on the 1994 MWC rulemaking, and AP-42 (5th edition). None of the data listed provides credit for supplemental dioxin control (polishing) by carbon injection. The use of carbon injection typically reduces dioxin emissions by an additional 75 percent or more. (See Air Docket A-90-45, items VI-B-013 and VI-B-014).

\* ESP operated at less than 440°F.

APCD = air pollution control device  
 DSI = duct sorbent injection  
 EA = excess air  
 EGB = electrified gravel bed  
 ESP = electrostatic precipitator  
 FB = fluidized bed  
 FF = fabric filter  
 MB = mass burn

MOD = modular  
 RC = rotary combustor  
 RDF = refuse derived fuel  
 REF = refractory wall  
 SA = starved air  
 SD = spray dryer  
 WW = waterwall

50:1. This ratio was used for estimating TEQ emissions for all sources where TEQ test data were not available.

The  $F_d$  factor is a standard conversion factor used in combustion calculations to determine exhaust flowrates based on heat input. Full documentation of  $F_d$  factors is given in 40 CFR 60, Appendix A, Method 19. The specific  $F_d$  factor for municipal waste combustion, given by Method 19, is 9,570 dry standard cubic feet of flue gas per million Btu (dscf/MMBtu) of municipal waste combustion. This flow rate is based on 0 percent  $O_2$  in the flue gases.

Average heating values for fuels derived from municipal wastes are given in the Refuse Combustion section of AP-42. For unprocessed municipal solid waste (MSW), the heating value is 4,500 Btu per pound. For RDF, the heating value is 5,500 Btu per pound. The heating value for RDF is higher than general MSW because RDF goes through some degree of pre-processing to remove non-combustible materials.

The first step in calculating annual dioxin emissions from MWCs was to calculate the emissions from individual units. This task was accomplished with plant-specific information such as dioxin emission concentration, unit size, unit capacity factor, fuel heating value, and the  $F_d$  factor.

The following equation was used to convert dioxin stack concentrations (total and TEQ) to grams per year (g/yr) emitted:

$$\text{Emissions} \left( \frac{\text{g}}{\text{yr}} \right) = \frac{C \times V \times T \times CF}{10^9}$$

where:

- Emissions = Annual dioxin emissions (g/yr)
- C = Flue Gas Dioxin Concentration (ng/dscm @7 percent  $O_2$ )
- V = Volumetric Flow Factor (dscm @7 percent  $O_2$ /ton waste fired)

- T = Tons of MSW burned/year (@100 percent capacity for 365 days/year)
- CF = Capacity Factor (unitless)

The volumetric flow factor (V) is calculated as follows:

$$V = \frac{F_d \times HV \times 2000 \times 10^{-6}}{35.31} \times \frac{20.9}{20.9-7}$$

where:

HV = Heating Value (4,500  $\frac{\text{Btu}}{\text{lb}}$  for MSW and 5,500  $\frac{\text{Btu}}{\text{lb}}$  for RDF)

$$V = \frac{\left( 9,570 \frac{\text{dscf @ 0\% O}_2}{\text{MMBtu}} \right) \left( 4,500 \frac{\text{Btu}}{\text{lb}} \right) \left( 2,000 \frac{\text{lb}}{\text{ton}} \right)}{\left( 35.31 \frac{\text{dscf}}{\text{dscm}} \right) \left( 10^6 \frac{\text{Btu}}{\text{MMBtu}} \right)} \times \left( \frac{20.9}{20.9 - 7} \right)$$

$$= 3,668 \frac{\text{dscm @ 7\%O}_2}{\text{ton MSW}} \text{ for non-RDF units}$$

$$V = \frac{\left( 9,570 \frac{\text{dscf @ 0\% O}_2}{\text{MMBtu}} \right) \left( 5,500 \frac{\text{Btu}}{\text{lb}} \right) \left( 2,000 \frac{\text{lb}}{\text{ton}} \right)}{\left( 35.31 \frac{\text{dscf}}{\text{dscm}} \right) \left( 10^6 \frac{\text{Btu}}{\text{MMBtu}} \right)} \times \left( \frac{20.9}{20.9 - 7} \right)$$

$$= 4,482 \frac{\text{dscm @ 7\%O}_2}{\text{ton RDF}} \text{ for RDF units}$$



### Example Calculation

For a mass burn/waterwall (non-RDF) unit, rated at 500 tons/day capacity (365,000 tons/yr), with a dioxin concentration of 10 ng/dscm (total mass) @7 percent O<sub>2</sub>, annual dioxin emissions are calculated to be:

$$\frac{\left( \frac{10 \text{ ng}}{\text{dscm}} @ 7\% \text{ O}_2 \right) \left( 3,670 \frac{\text{dscm @ 7\% O}_2}{\text{ton}} \right) \left( 182,500 \frac{\text{ton}}{\text{yr}} \right) (0.91)}{10^9 \frac{\text{ng}}{\text{g}}}$$

= 6.1 g dioxin/yr (total mass), or

= 6.1/50 = 0.12 g dioxin/yr (TEQ)

Individual emission estimates were developed for all operational MWCs in the U.S., and the individual estimates were summed to provide the 1993 national CDD/CDF emissions estimate for MWCs.

The 1995 CDD/CDF estimate is based on the same data and methodology as that used to develop the 1993 estimate. To develop the 1995 estimate, data for 11 facilities were adjusted to reflect reduced emissions levels. During the 1993 inventory, 11 facilities were found to have elevated dioxin emission concentrations and corrective actions were initiated at these MWCs to reduce emissions. The 1995 CDD/CDF emissions estimate incorporates the expected emissions reductions at these facilities after corrective actions have been taken. The development of the 1995 CDD/CDF estimate is discussed in detail in Reference 1.

The national emissions estimate of 2,3,7,8-TCDD TEQ from MWCs is 1.61 lb/yr.

## MEDICAL WASTE INCINERATION

### Basis for Calculation

There are approximately 3,400 medical facilities in the United States.<sup>2</sup> Using facility capacities, it was estimated that about 846,000 tons of medical waste were incinerated in 1995.<sup>5</sup> The national dioxin/furan emissions estimates for medical waste incinerations (MWIs) were obtained directly from work done by EPA's Emission Standards Division (ESD) to support Maximum Achievable Control Technology (MACT) standards for this source category.<sup>6</sup> A summary of the methods used to determine the estimates are provided here. More detailed information on the derivation of the estimates can be obtained from Reference 6.

The starting point for the national estimates is a 1995 inventory of existing MWIs, which includes for each MWI the location, type (batch or non-batch), and the design capacity of the unit. The information used to develop the inventory was taken from a number of sources including a listing of MWIs prepared by the American Hospital Association (AHA), state air permits gathered by EPA, and a survey of MWIs in California and New York conducted by EPA in 1995. The AHA inventory was itself taken from two sources; an EPA "Locating and Estimating" document and a vendor listing. Once this information was compiled, the inventory was reviewed and modified based on updates from state surveys, commercial sources, and MWI vendors.

The capacity of each MWI was provided in the inventory. The capacities for the continuous and intermittent MWIs in the inventory were expressed in terms of an hourly charging rate in pounds per hour (lb/hr). Batch MWI capacities were provided in pounds per batch (lb/batch). Therefore, batch MWIs were evaluated separately from the continuous and intermittent MWIs and the batch capacities were not converted to hourly burning rates.<sup>6</sup>

Also included in the inventory was the applicable state particulate matter (PM) emission limit for each MWI. The AHA listing of MWIs and the state air permits included PM limits for each MWI.

Where PM limits were not listed, limits were applied based on State regulatory requirements using the same methods described in the MACT floor analysis for the proposed standards. PM limits could be used to estimate the type of emission control at MWIs for which the control was not identified for the MWI.

Nationwide MWI emissions were calculated by first calculating MWI emissions on a unit specific basis using the MWI inventory and considering unit specific parameters. Actual emission control data was used where available and was estimated when not available. In calculating emissions and estimating operating parameters, there are three distinct types of MWIs as follows: batch, intermittent, and continuous. The difference in these three MWI types is in the methods of charging waste to the MWI and removing ash from the primary chamber of the MWI. Continuous MWIs, which are the largest of the three types, have mechanical ram feeders and continuous ash removal systems. These features allow the unit to operate 24 hours per day for many days at a time. Most intermittent MWIs also have mechanical ram feeders that charge waste into the primary chamber. However, intermittent MWIs do not have an automatic ash removal system, and can only be operated for a limited number of hours before the unit must be shut down for ash removal. In batch MWIs, all of the waste to be burned is loaded into the primary chamber and, once the burning cycle begins, no additional waste is loaded. After the burn cycle for a batch unit is complete and the unit has cooled down, the ash is removed manually. In the inventory of existing MWIs used to estimate the nationwide dioxin emissions, a differentiation was made between batch and nonbatch (continuous and intermittent) MWIs. However, no distinction was made between continuous and intermittent MWIs in the final inventory.<sup>6</sup>

The hours of operation were estimated for each MWI type in the inventory in order to determine the annual waste incinerated. The hours of operation were defined as the hours during which the MWI combusts waste.

For batch MWIs, it is estimated that a typical MWI charges waste 160 times per year (i.e., 160 batches/yr; 3 batches per week). The amount of waste burned each year in a batch unit and the

yearly emissions produced depend primarily on the unit capacity and the annual number of batches. Because of this relationship, it was unnecessary to determine the actual hours of operation for batch MWIs.

For continuous and intermittent MWIs, operating hours were estimated for three size categories ( $\leq 500$ , 501 to 1,000, and  $>1,000$  lb/hr). All MWIs with capacities less than 500 lb/hr were assumed to be intermittent MWIs. The waste charging hours for intermittent MWIs with capacities less than 500 lb/hr were estimated at 1,250 hours per year (hr/yr). Since the inventory does not indicate whether an MWI is continuous or intermittent, a ratio of about 3 to 1, intermittent to onsite continuous, was used to estimate the hours of operation for onsite continuous and intermittent MWIs with capacities greater than 500 lb/hr. The average operating hours for continuous MWIs in the 501 to 1,000 lb/hr size category was 2,916 hr/yr and the average charging hours for intermittent MWIs in this size category was 1,500 hr/yr. The weighted average of the charging hours for the combined continuous and intermittent MWIs was determined as follows:

$$(1,500 \text{ hr/yr} \times 0.77) + (2,916 \text{ hr/yr} \times 0.23) = 1,826 \text{ hr/yr}$$

Large MWIs with design capacities greater than 1,000 lb/hr were estimated to operate 2,174 hr/yr and all commercial MWIs were estimated to operate 7,776 hr/yr. A summary of the waste charging hours for the continuous and intermittent MWIs is presented below.<sup>6</sup>

MWI Capacity	Charging Hours (hr/yr)	Capacity Factor (%)
<500 lb/hr	1,250	29
501-1,000 lb/hr	1,826	33
>1,000 lb/hr	2,174	40
All commercial MWIs	7,776	89

NOTE: "Capacity factor" means ratio of tons of waste actually burned per year divided by the tons of waste that could be burned per year had the unit been operating at full capacity.

A capacity factor represents the percentage of operational time a MWI has operated in 1 year. Capacity factors were calculated for each MWI size category based on the ratio of the actual annual charging hours to the maximum annual charging hours. For intermittent MWIs, the maximum annual charging hours were estimated to be 4,380 hr/yr. This is based on 12 charging hours per day and 365 days per year because intermittent MWIs must shut down for daily ash removal. The maximum annual charging hours for continuous MWIs were estimated to be 8,760 hr/yr based on 24 charging hours per day and 365 days per year. All commercial MWIs were assumed to be continuous units. The maximum annual charging hours for onsite MWIs with capacities greater than 500 lb/hr were estimated to be 5,475 hr/yr, based on the 3 to 1 ratio of intermittent to onsite continuous MWIs discussed previously. The calculated capacity factors for each MWI size category are shown in the box on the previous page.

Waste charging rates measured during emissions tests show the average hourly charging rates to be about two-thirds of the MWI design rates specified by incinerator manufacturers. Therefore, waste was assumed to be charged at two-thirds of the MWI design capacity. Using the operating hours per year (or number of batches per year for batch units) and the corrected waste charge rate (two-thirds of the design rate), the amount of waste burned annually was determined for each MWI.

Actual emission control data was used where available and was estimated when necessary. When emission control system type was unknown it was estimated based on (1) the average PM emission rates for the different types of emission controls and (2) the PM limit to which the MWI is subject. For example, the average PM emission rate for intermittent and continuous MWIs with 1/4-second combustion control was estimated from test data to be 0.30 grains per dry standard cubic feet (gr/dscf). Thus, any MWI with a PM emission limit greater than 0.30 gr/dscf was assumed to have a 1/4-second combustion system. The PM emission limit ranges for all of the emission controls are shown below.

PM Emission Limit (gr/dscf at 7% O <sub>2</sub> )	Assumed Level of Emission Control
Intermittent and continuous MWIs	
≥0.3	1/4-sec combustion control
0.16 ≤ x <0.3	1-sec combustion control
.10 ≤ x 0.16	2-sec combustion control
0.015 < x <0.10	Wet scrubbers
≤ 0.015	Dry scrubbers
Batch MWIs	
≥ 0.079	1/4-sec combustion control
0.042 ≤ x < 0.079	1-sec combustion control
0.026 ≤ x <0.042	2-sec combustion control
<0.026	Wet scrubbers

An analysis of EPA-sponsored emission test data showed a direct relationship between the CDD/CDF emissions on a "total" dioxin basis and a "TEQ" basis. For total CDD/CDF emissions greater than 150 nanograms per dry standard cubic meter (ng/dscm), the ratio of total CDD/CDF emissions to the TEQ emissions was 48:1. For total CDD/CDF emissions less than 150 ng/dscm, the ratio was 42:1. These ratios were used with test data on total CDD/CDF emissions to develop TEQ emission factors for each type of emission control. The resulting dioxin and TEQ emission factors are shown in Table A-3.

**Table A-3**

**Total Dioxin and TEQ Emission Factors**

Type of Emission Control	TEQ Factors, lb/TEQ Dioxin/lb Waste	Dioxin Factors, lb Total Dioxin/lb Waste
1/4-sec combustion control	3.96 x 10 <sup>-9</sup>	1.94 x 10 <sup>-7</sup>
1-sec combustion control	9.09 x 10 <sup>-10</sup>	4.45 x 10 <sup>-8</sup>
2-sec combustion control	7.44 x 10 <sup>-11</sup>	3.65 x 10 <sup>-9</sup>
Wet scrubbers	1.01 x 10 <sup>-11</sup>	4.26 x 10 <sup>-10</sup>
Dry scrubbers no carbon	7.44 x 10 <sup>-11</sup>	3.65 x 10 <sup>-10</sup>
Dry scrubbers with carbon	1.68 x 10 <sup>-12</sup>	7.04 x 10 <sup>-11</sup>
Fabric filter/packed bed	6.81 x 10 <sup>-10</sup>	3.34 x 10 <sup>-8</sup>

In combination with the MWI parametric data, control technology data, and emission factors the following equation calculates the annual dioxin emissions from each MWI in the MWI inventory:

$$\text{Emissions} = (C \times H \times C_1) \times F \times Q$$

Where:

Emissions	=	Annual dioxin emissions, g/yr
C	=	MWI capacity, lb/hr
H	=	Charging hours, hr/yr
C <sub>1</sub>	=	Ratio of waste charging rate to design capacity, 2:3
F	=	Emission factor for the appropriate level of control (lb dioxin/lb waste charged), and
Q	=	Conversion factor for pounds to grams, 453.6 grams/lb.

The CDD/CDF emissions from the individual MWIs in the inventory were calculated by multiplying the annual amount of waste burned by the appropriate emission factor from Table A-3. Next, the annual emissions from each MWI were summed to estimate the total 1995 CDD/CDF emissions from MWIs. CDD/CDF emissions from MWIs in 1995 are estimated to be 16 pounds on a total mass basis and 0.332 pounds on a 2,3,7,8-TCDD TEQ basis.<sup>6</sup>

## SEWAGE SLUDGE INCINERATION

### Basis for Calculation

In 1995, there were 143 operating sewage sludge facilities in the United States,<sup>2</sup> and more than 80 percent of the facilities were multiple hearth incinerators.<sup>7</sup> In 1992, approximately  $9.5 \times 10^5$  tons of dry sewage sludge were incinerated.<sup>2</sup> Emission factors for 2,3,7,8-TCDD and 2,3,7,8-TCDF from a multiple hearth incinerator with an impingement tray scrubber in place were obtained from AP-42.<sup>7</sup> The emission factors were multiplied by the tons of sludge incinerated to estimate emissions.

Activity Level	2,3,7,8-TCDD Emission Factor	2,3,7,8-TCDF Emission Factor	2,3,7,8-TCDD TEQ Emission Factor
$9.5 \times 10^5$ ton incinerated	$1.0 \times 10^{-9}$ lb/ton sludge incinerated	$3.6 \times 10^{-7}$ lb/ton sludge incinerated	$5.57 \times 10^{-8}$ lb/ton sludge incinerated

### Example Calculation

$$\begin{aligned} 2,3,7,8\text{-TCDD national emissions estimate} &= (9.5 \times 10^5 \text{ ton/yr incinerated}) \\ &\quad \times (1.0 \times 10^{-9} \text{ lb/ton incinerated}) \\ &= 9.5 \times 10^{-4} \text{ lb/yr} \end{aligned}$$

$$\begin{aligned} 2,3,7,8\text{-TCDF national emissions estimate} &= (9.5 \times 10^5 \text{ ton/yr incinerated}) \\ &\quad \times (3.6 \times 10^{-7} \text{ lb/ton incinerated}) \\ &= 3.42 \times 10^{-1} \text{ lb/yr} \end{aligned}$$

$$\begin{aligned} 2,3,7,8\text{-TCDD TEQ national emissions estimate} &= (9.5 \times 10^5 \text{ ton/yr incinerated}) \\ &\quad \times (5.57 \times 10^{-8} \text{ lb/ton incinerated}) \\ &= 5.29 \times 10^{-2} \text{ lb/yr} \end{aligned}$$



# HAZARDOUS WASTE INCINERATION

## Basis for Calculation

The activity data for dioxins/furans were derived from total quantities of hazardous waste generated. In 1992, approximately 249 million metric tons (274 million tons) of hazardous waste were generated.<sup>2</sup> It is estimated that of the total amount of hazardous waste generated, only 1.3 million metric tons (1.43 million tons) were burned in dedicated hazardous waste facilities, and 1.2 million metric tons (1.32 million tons) were burned in boilers and industrial furnaces (BIFs).<sup>8</sup>

Emission factors reported in Section 4.1.4 of this document for hazardous waste incinerators and the activity data reported in Reference 2 were used to estimate national emissions of 2,3,7,8-TCDD/TCDF. The factors were developed from testing performed at the EPA's Incineration Research Facility designed to evaluate PCB destruction and removal efficiency. The waste feed during testing was PCB-contaminated sediments. The test incinerator was equipped with a venturi scrubber followed by a packed column scrubber. The activity level and emission factor were multiplied to calculate national 2,3,7,8-TCDD/TCDF emissions from hazardous waste incinerators.

Activity Level	2,3,7,8-TCDD Emission Factor	2,3,7,8-TCDF Emission Factor
1.43x10 <sup>6</sup> ton incinerated	1.68x10 <sup>-10</sup> lb/ton waste incinerated	1.91x10 <sup>-8</sup> lb/ton waste incinerated

## Calculations

$$\begin{aligned} 2,3,7,8\text{-TCDD national emissions estimate} &= (1.68 \times 10^{-10} \text{ lb/ton waste incinerated}) \\ &\quad \times (1.43 \times 10^6 \text{ ton/yr waste incinerated}) \\ &= 2.40 \times 10^{-4} \text{ lb/yr} \end{aligned}$$

$$\begin{aligned} 2,3,7,8\text{-TCDF national emissions estimate} &= (1.91 \times 10^{-8} \text{ lb/ton waste incinerated}) \\ &\quad \times (1.43 \times 10^6 \text{ ton/yr waste incinerated}) \\ &= 0.0273 \text{ lb/yr} \end{aligned}$$

The national emissions estimate for 2,3,7,8-TCDD TEQ from HWIs was developed as part of recent EPA regulatory programs for hazardous waste combustors. The TEQ estimate is 22 grams/yr (0.049 lb/yr) and represents 1996 emissions.<sup>9,10</sup>

## LIGHTWEIGHT AGGREGATE KILNS (LWAKs)

### Basis for Calculation

The national emissions for LWAKs was obtained from an EPA document that presents national emissions estimates for hazardous waste combustor systems.<sup>10,11</sup> The document presents an estimate of  $6.92 \times 10^{-3}$  lb/yr of 2,3,7,8-T-CDD TEQ emissions from LWAKs.

## PORTLAND CEMENT

### Basis for Calculation

National emissions estimates for the Portland cement source category were developed for kilns burning non-hazardous waste (NHW) and for kilns burning hazardous waste (HW). The estimate for NHW kilns was taken directly from estimates prepared by the EPA to support the Portland Cement Manufacturing Industry NESHAP standards program.<sup>12,13</sup> The estimate for HW kilns was obtained from an EPA document that presents national emissions estimates for hazardous waste combustor systems.<sup>10,11</sup> The details of the estimation process and the data used to develop national estimates can be found in References 10 and 13.

### Non-Hazardous Waste (NHW) Kilns

Emissions from NHW kilns were only estimated on the basis of a dioxin/furan TEQ. Average TEQ concentrations were determined from actual test data for existing facilities of varying types, design, and control configurations. An average TEQ concentration of 0.25 ng/dry standard cubic meter (dscm) of flow was determined and used to calculate national emissions. The national kiln clinker production rate used in the calculation was 67.6 million tons of clinker produced per year from NHW kilns. Additional information used in the calculation were 66,225 dscf of flow/ton dry feed material and 1.65 ton dry feed/ton of clinker produced. The values for these variables are included in the Technical Background Document for the standard. The equation used to calculate the national emissions estimate from NHW kilns is as follows:<sup>12</sup>

$$\frac{\text{ng}}{\text{dscm}} \times \frac{\text{m}^3}{35.3 \text{ ft}^3} \times \frac{\text{g}}{10^9 \text{ ng}} \times \frac{\text{lb}}{454 \text{ g}} \times \frac{66,225 \text{ dscf}}{\text{ton dry feed}} \times \frac{1.65 \text{ ton dry feed}}{\text{ton clinker}} \times \frac{\text{ton clinker}}{\text{yr}} = \frac{\text{lb TEQ}}{\text{yr}}$$

The national estimate of 2,3,7,8-TCDD TEQ emissions from NHW kilns is 0.12 lb/yr.

### Hazardous Waste Kilns

The national emissions for HW kilns was obtained from an EPA document that presents national emissions estimates for hazardous waste combustor systems.<sup>10,11</sup> This document presents an estimate of 0.13 lb/yr of 2,3,7,8-TCDD TEQ emissions from HW kilns.

## WASTE TIRE INCINERATION

### Basis for Calculation

Emission factors for 2,3,7,8-TCDD/TCDF emissions from waste tire incineration (tire-to-energy facility using a spray dryer, flue gas desulfurization followed by a fabric filter) were obtained from source testing.<sup>14</sup> A national estimate of  $5.5 \times 10^5$  tons of waste tires incinerated per year was obtained from EPA's Office of Solid Waste.<sup>15</sup> The activity data and emission factors were multiplied to calculate national 2,3,7,8-TCDD/TCDF emissions from waste tire incinerators.

Activity Level	2,3,7,8-TCDD Emission Factor	2,3,7,8-TCDF Emission Factor	2,3,7,8-TCDD TEQ Emission Factor
$5.5 \times 10^5$ ton tires incinerated	$2.16 \times 10^{-11}$ lb/ton tires incinerated	$5.42 \times 10^{-11}$ lb/ton tires incinerated	$1.08 \times 10^{-9}$ lb/ton tires incinerated

### Calculation

$$\begin{aligned} 2,3,7,8\text{-TCDD national emissions estimate} &= (5.5 \times 10^5 \text{ ton/yr tires incinerated}) \\ &\quad \times (2.16 \times 10^{-11} \text{ lb/ton tires incinerated}) \\ &= 1.19 \times 10^{-5} \text{ lb/yr} \end{aligned}$$

$$\begin{aligned} 2,3,7,8\text{-TCDF national emissions estimate} &= (5.5 \times 10^5 \text{ ton/yr tires incinerated}) \\ &\quad \times (5.42 \times 10^{-11} \text{ lb/ton tires incinerated}) \\ &= 2.98 \times 10^{-5} \text{ lb/yr} \end{aligned}$$

$$\begin{aligned} 2,3,7,8\text{-TCDD TEQ national emissions estimate} &= (5.5 \times 10^5 \text{ ton/yr tires incinerated}) \\ &\quad \times (1.08 \times 10^{-9} \text{ lb/ton tires incinerated}) \\ &= 5.94 \times 10^{-4} \text{ lb/yr} \end{aligned}$$

## UTILITY COAL COMBUSTION

### Basis for Calculation

The national 2,3,7,8-TCDD, 2,3,7,8-TCDF, and 2,3,7,8-TCDD TEQ emissions estimates and factors for utility coal combustion were obtained from an EPA study on toxic pollutants from utility boilers conducted over the past several years.<sup>16</sup> The EPA is conducting this study in response to a Clean Air Act mandate to prepare a Report to Congress on toxic emissions from utility sources. It is important to note that these data are preliminary and have not yet been finalized by the EPA. Also, the factors do not represent a specific source but are composites of individual factors for various furnace configurations and control devices. The factors and estimates developed from the utility boiler study are presented below.

CDD/CDF	Emission Factor (lb/trillion Btu)	1990 Emission Estimate (ton/yr)	1990 Emission Estimate (lb/yr)
2,3,7,8-TCDD	$1.6 \times 10^{-4}$	$1.4 \times 10^{-5}$	0.028
2,3,7,8-TCDF	$3.9 \times 10^{-6}$	$3.4 \times 10^{-5}$	0.068
2,3,7,8-TCDD TEQ	Not reported	$1.5 \times 10^{-4}$	0.30

Note: These values are draft estimates and have not been finalized by the EPA.

## UTILITY RESIDUAL OIL COMBUSTION

### Basis for Calculation

The national 2,3,7,8-TCDD, 2,3,7,8-TCDF, and 2,3,7,8-TCDD TEQ emissions estimates and factors for utility residual oil combustion were obtained from an EPA study on toxic pollutants from utility boilers conducted over the past several years.<sup>16</sup> The EPA is conducting this study in response to a Clean Air Act mandate to prepare a Report to Congress on toxic emissions from utility sources. It is important to note that these data are preliminary and have not yet been finalized by the EPA. Also, the factors do not represent a specific source but are composites of individual factors for various furnace configurations and control devices. The factors and estimates developed from the utility boiler study are presented below.

CDD/CDF	Emission Factor (lb/trillion Btu)	1990 Emission Estimate (ton/yr) <sup>9</sup>	1990 Emissions Estimate (lb/yr)
2,3,7,8-TCDD	$6.5 \times 10^{-6}$	$4.0 \times 10^{-6}$	0.008
2,3,7,8-TCDF	$4.6 \times 10^{-6}$	$2.9 \times 10^{-6}$	0.0058
2,3,7,8-TCDD TEQ	Not Reported	$1.1 \times 10^{-5}$	0.022

Note: These values are draft estimates and have not been finalized by the EPA.



## INDUSTRIAL WOOD COMBUSTION

### Basis for Calculation

Emission factors for 2,3,7,8-TCDD and 2,3,7,8-TCDF emissions from industrial wood combustion were obtained from source test data and used to estimate national emissions. The emission factors represent the average of two processes, controls, and fuel types.<sup>2</sup> Data from the nine boilers tested by the National Council of the Paper Industry for Air and Stream Improvements, Inc. (NCASI) were used to develop the 2,3,7,8-TCDD TEQ emission factor that was used to estimate national emissions.<sup>17</sup> A national estimate of the amount of wood combusted in industrial boilers was obtained from the Department of Energy.<sup>18</sup> The activity data and the emission factor were multiplied to calculate national 2,3,7,8-TCDD/TCDF emissions from industrial wood combustion.

Activity Level	2,3,7,8-TCDD Emission Factor	2,3,7,8-TCDF Emission Factor	2,3,7,8-TCDD TEQ Emission Factor
$9.06 \times 10^7$ ton dry wood burned	$7.34 \times 10^{-11}$ lb/ton dry wood burned	$1.05 \times 10^{-10}$ lb/ton dry wood burned	$2.48 \times 10^{-9}$ lb/ton dry wood burned

### Example Calculation

$$\begin{aligned} 2,3,7,8\text{-TCDD TEQ national emissions estimate} &= (9.06 \times 10^7 \text{ ton/yr dry wood burned}) \\ &\quad \times (2.48 \times 10^{-9} \text{ lb/ton dry wood burned}) \\ &= 2.25 \times 10^{-1} \text{ lb/yr} \end{aligned}$$

$$\begin{aligned} 2,3,7,8\text{-TCDD national emissions estimate} &= (9.06 \times 10^7 \text{ ton/yr dry wood burned}) \\ &\quad \times (7.34 \times 10^{-11} \text{ lb/ton dry wood burned}) \\ &= 6.65 \times 10^{-3} \text{ lb/yr} \end{aligned}$$

$$\begin{aligned} 2,3,7,8\text{-TCDF national emissions estimate} &= (9.06 \times 10^7 \text{ ton/yr dry wood burned}) \\ &\quad \times (1.05 \times 10^{-10} \text{ lb/ton dry wood burned}) \\ &= 9.51 \times 10^{-3} \text{ lb/yr} \end{aligned}$$

## RESIDENTIAL COAL COMBUSTION

### Basis for Calculation

Emission factors based on dioxin/furan concentrations in soot samples collected from seven coal furnaces and AP-42 particulate matter (PM) emission factors were obtained for both bituminous and anthracite coal combustion.<sup>2</sup> For the purposes of estimating emissions, it was assumed that the concentrations of CDD/CDF in the PM emitted from residential coal combustion are the same as those measured in the soot samples. A 1990 national estimate of the amount of residential coal combusted for the two coal types was obtained from the Department of Energy report.<sup>19</sup> The activity levels and emission factors for the two coal types were multiplied and then added together to estimate national 2,3,7,8-TCDD/TCDF emissions from residential coal combustion.

Activity Level	2,3,7,8-TCDD Emission Factor	2,3,7,8-TCDF Emission Factor	2,3,7,8-TCDD TEQ Emission Factor
1.93 x 10 <sup>6</sup> ton bituminous coal	4.79 x 10 <sup>-9</sup> lb/ton bituminous coal burned	1.26 x 10 <sup>-7</sup> lb/ton bituminous coal burned	1.97 x 10 <sup>-7</sup> lb/ton bituminous coal burned
7.32 x 10 <sup>5</sup> ton anthracite coal	3.20 x 10 <sup>-9</sup> lb/ton anthracite coal burned	8.39 x 10 <sup>-8</sup> lb/ton anthracite coal burned	1.20 x 10 <sup>-7</sup> lb/ton anthracite coal burned

Note: These values are draft estimates and have not been finalized by the EPA.

## Calculation

$$\begin{aligned} \text{2,3,7,8-TCDD national emissions} &= (4.79 \times 10^{-9} \text{ lb/ton bituminous coal burned}) \\ \text{estimate, bituminuous coal} & \\ & \times (1.93 \times 10^6 \text{ ton/yr bituminous coal burned}) \\ & = 9.24 \times 10^{-3} \text{ lb/yr} \end{aligned}$$

$$\begin{aligned} \text{2,3,7,8-TCDD national emissions} &= (3.20 \times 10^{-9} \text{ lb/ton anthracite coal burned}) \\ \text{estimate, anthracite coal} & \\ & \times (7.32 \times 10^5 \text{ ton/yr anthracite coal burned}) \\ & = 2.34 \times 10^{-3} \text{ lb/yr} \end{aligned}$$

$$\begin{aligned} \text{2,3,7,8-TCDD national emissions} &= 2.34 \times 10^{-3} \text{ lb/yr} + 9.24 \times 10^{-3} \text{ lb/yr} \\ \text{estimate (both coal types)} & \\ & = 1.16 \times 10^{-2} \text{ lb/yr} \end{aligned}$$

$$\begin{aligned} \text{2,3,7,8-TCDF national emissions} &= (1.93 \times 10^6 \text{ ton/yr bituminous coal burned}) \\ \text{estimate, bituminuous coal} & \\ & \times (1.26 \times 10^{-7} \text{ lb/ton bituminous coal burned}) \\ & = 2.43 \times 10^{-1} \text{ lb/yr} \end{aligned}$$

$$\begin{aligned} \text{2,3,7,8-TCDF national emissions} &= (7.32 \times 10^5 \text{ ton/yr anthracite coal burned}) \\ \text{estimate, anthracite coal} & \\ & \times (8.39 \times 10^{-8} \text{ lb/ton anthracite coal burned}) \\ & = 6.14 \times 10^{-2} \text{ lb/yr} \end{aligned}$$

$$\begin{aligned} \text{2,3,7,8-TCDF national emissions} &= 2.43 \times 10^{-1} \text{ lb/yr} + 6.14 \times 10^{-2} \text{ lb/yr} \\ \text{estimate (both coal types)} & \\ & = 3.05 \times 10^{-1} \text{ lb/yr} \end{aligned}$$

$$\begin{aligned} \text{2,3,7,8-TCDD TEQ national emissions} &= (1.93 \times 10^6 \text{ ton/yr bituminous coal burned}) \\ \text{estimate, bituminuous coal} & \quad \times (1.97 \times 10^{-7} \text{ lb/ton bituminous coal burned}) \\ &= 3.80 \times 10^{-1} \text{ lb/yr} \end{aligned}$$

$$\begin{aligned} \text{2,3,7,8-TCDD TEQ national emissions} &= (7.32 \times 10^5 \text{ ton/yr anthracite coal burned}) \\ \text{estimate, anthracite coal} & \quad \times (1.20 \times 10^{-7} \text{ lb/ton anthracite coal burned}) \\ &= 8.78 \times 10^{-2} \text{ lb/yr} \end{aligned}$$

$$\begin{aligned} \text{2,3,7,8-TCDD TEQ national emissions} &= 3.80 \times 10^{-1} \text{ lb/yr} + 8.78 \times 10^{-2} \text{ lb/yr} \\ \text{estimate (both coal types)} & \\ &= 4.68 \times 10^{-1} \text{ lb/yr} \end{aligned}$$

## RESIDENTIAL DISTILLATE FUEL OIL COMBUSTION

### Basis for Calculation

Emission factors based on dioxin/furan concentrations in soot samples collected from 21 distillate fuel oil-fired furnaces used in central heating and AP-42 particulate emission (PM) factors for residential distillate oil-fired furnaces were obtained.<sup>2,4</sup> For the purpose of estimating emissions, it was assumed that the concentrations of CDD/CDF in the PM emitted from residential distillate fuel oil combustion are the same as those measured in the soot samples. 2,3,7,8-TCDD/TCDF isomer specific emission factors and homologue totals were used in calculating 2,3,7,8-TCDD TEQs. A 1990 national estimate of the amount of residential fuel oil combusted was obtained from the Department of Energy.<sup>19</sup> The activity data and the emission factor were multiplied to estimate national CDD/CDF emissions from residential distillate fuel oil combustion.

Activity Level	2,3,7,8-TCDD Emission Factor	2,3,7,8-TCDF Emission Factor	2,3,7,8-TCDD TEQ Emission Factor
1.44 x 10 <sup>8</sup> barrels burned	1.96 x 10 <sup>-8</sup> lb/10 <sup>3</sup> barrels burned	1.86 x 10 <sup>-8</sup> lb/10 <sup>3</sup> barrels burned	5.26 x 10 <sup>-8</sup> lb/10 <sup>3</sup> barrels burned

### Calculation

$$\begin{aligned} 2,3,7,8\text{-TCDD national emissions estimate} &= (1.44 \times 10^8 \text{ barrels/yr burned}) \\ &\quad \times (1.96 \times 10^{-8} \text{ lb/10}^3 \text{ barrels}) \\ &= 2.82 \times 10^{-3} \text{ lb/yr} \end{aligned}$$

$$\begin{aligned} 2,3,7,8\text{-TCDF national emissions estimate} &= (1.44 \times 10^8 \text{ barrels/yr burned}) \\ &\quad \times (1.86 \times 10^{-8} \text{ lb/10}^3 \text{ barrels burned}) \\ &= 2.68 \times 10^{-3} \text{ lb/yr} \end{aligned}$$

$$\begin{aligned} 2,3,7,8\text{-TCDD TEQ national emissions estimate} &= (1.44 \times 10^8 \text{ barrels/yr burned}) \\ &\quad \times (5.26 \times 10^{-8} \text{ lb/10}^3 \text{ barrels burned}) \\ &= 7.57 \times 10^{-3} \text{ lb/yr} \end{aligned}$$

## RESIDENTIAL WOOD COMBUSTION

### Basis for Calculation

29.1 million cords (33.8 million tons) of wood were combusted in residential wood combustors in 1990.<sup>20,21</sup> The nationwide percentage of wood consumption is 28 percent for fireplaces and 72 percent for woodstoves.<sup>2</sup> Of the 72 percent combusted in woodstoves, no more than five percent is combusted in catalytic and noncatalytic stoves.<sup>22</sup> For calculational purposes, it is assumed the remaining 95 percent (of the 72 percent) is combusted in conventional woodstoves.

The dioxin/furan factors used to estimate emissions from residential wood combustion are weighted emission factors that represent fireplace and woodstove use. Dioxin/furan emission estimates attributed to residential wood combustion were based on a methodology developed by EPA's Office of Health and Environmental Assessment (now named the National Center for Environmental Assessment).<sup>23</sup> Using two recent studies (conducted in Switzerland and Denmark) that reported direct measurement of CDD/CDF emissions from wood stoves, an average emission factor of  $2 \times 10^{-9}$  lb TEQ/ton (1 ng TEQ/kg) was derived.

Activity Level	2,3,7,8-TCDD Emission Factor	2,3,7,8-TCDF Emission Factor	2,3,7,8-TCDD TEQ Emission Factor
$3.38 \times 10^7$ ton dry wood burned	$2.55 \times 10^{-11}$ lb/ton dry wood burned	$8.90 \times 10^{-10}$ lb/ton dry wood burned	$2.00 \times 10^{-9}$ lb/ton dry wood burned

### Example Calculation

$$\begin{aligned}
 \text{2,3,7,8-TCDD TEQ national emissions estimate} &= (3.38 \times 10^7 \text{ ton/yr dry wood burned}) \\
 &\quad \times (2.0 \times 10^{-9} \text{ lb/ton dry wood burned}) \\
 &= 6.76 \times 10^{-2} \text{ lb/yr}
 \end{aligned}$$



$$\begin{aligned} 2,3,7,8\text{-TCDD national emissions estimate} &= (3.38 \times 10^7 \text{ ton/yr dry wood burned}) \\ &\quad \times (2.55 \times 10^{-11} \text{ lb/ton dry wood burned}) \\ &= 8.62 \times 10^{-4} \text{ lb/yr} \end{aligned}$$

$$\begin{aligned} 2,3,7,8\text{-TCDF national emissions estimate} &= (3.38 \times 10^7 \text{ ton/yr dry wood burned}) \\ &\quad \times (8.90 \times 10^{-10} \text{ lb/ton dry wood burned}) \\ &= 3.01 \times 10^{-2} \text{ lb/yr} \end{aligned}$$

## IRON AND STEEL FOUNDRIES

### Basis for Calculation

The national activity level for iron and steel foundries for 1990 is 10,199,820 ton of iron/steel product produced.<sup>2</sup> The national activity level estimate for ferrous foundries includes  $9.15 \times 10^6$  tons of iron castings and  $1.10 \times 10^6$  tons of steel castings produced by approximately 1100 foundries nationally in 1990.<sup>2</sup> The emission factors used to estimate CDD/CDF emissions from iron and steel foundries were derived from one facility test report.<sup>24</sup> The test report quantified emissions from a batch-operated cupola furnace charged with pig iron, scrap iron, steel scrap, coke, and limestone. Emission control devices in operation during the test were an oil-fired afterburner and a baghouse. Fully speciated dioxin/furan profiles were available to calculate 2,3,7,8-TCDD TEQs. The emission factors and activity level were multiplied to calculate 2,3,7,8-TCDD/TCDF emissions from iron and steel foundries.

Activity Level	2,3,7,8-TCDD Emission Factor	2,3,7,8-TCDF Emission Factor	2,3,7,8-TCDD TEQ Emission Factor
$1.02 \times 10^7$ ton iron/steel product	$2.47 \times 10^{-10}$ lb/ton product	$7.92 \times 10^{-9}$ lb/ton product	$3.68 \times 10^{-9}$ lb/ton product

### Example Calculation

$$\begin{aligned} 2,3,7,8\text{-TCDD national emissions estimate} &= (1.02 \times 10^7 \text{ ton/yr product}) \\ &\quad \times (2.47 \times 10^{-10} \text{ lb/ton product}) \\ &= 2.52 \times 10^{-3} \text{ lb/yr} \end{aligned}$$

$$\begin{aligned} 2,3,7,8\text{-TCDF national emissions estimate} &= (1.02 \times 10^7 \text{ ton/yr product}) \\ &\quad \times (7.92 \times 10^{-9} \text{ lb/ton product}) \\ &= 8.08 \times 10^{-2} \text{ lb/yr} \end{aligned}$$

$$\begin{aligned} 2,3,7,8\text{-TCDD TEQ national emissions estimate} &= (1.02 \times 10^7 \text{ ton/yr product}) \\ &\quad \times (3.68 \times 10^{-9} \text{ lb/ton product}) \\ &= 3.75 \times 10^{-2} \text{ lb/yr} \end{aligned}$$

## SECONDARY COPPER SMELTERS

### Basis for Calculation

The activity data for secondary copper smelters for 1990 is available, but there is no available emission factor that can be used with the activity data to estimate emissions.<sup>25</sup> Test data are available for 2,3,7,8-TCDD from one U.S. facility, but it is not possible to develop an emission factor from the data.<sup>25</sup> The test data were used to estimate annual 2,3,7,8-TCDD emissions from the single facility, and that estimate is reported as the national emissions estimate for the secondary copper smelting source category in this document. Also, the 2,3,7,8-TCDD emissions data were used to calculate an annual 2,3,7,8-TCDD TEQ emissions estimate and the estimate is presented in this document. Thus, it should be noted that the 2,3,7,8-TCDD TEQ emissions estimate is based on the 2,3,7,8-TCDD congener only. Emissions of other congeners are not accounted for in the 2,3,7,8-TCDD TEQ estimate because data were not available.<sup>26</sup> Also, it should be noted that the 2,3,7,8-TCDD and 2,3,7,8-TCDD TEQ national emissions estimate presented in this document represent only one facility.

The national emissions estimates for 2,3,7,8-TCDD and 2,3,7,8-TCDD TEQ from secondary copper smelters are  $1.36 \times 10^{-2}$  lb/yr and  $1.36 \times 10^{-2}$  lb/yr, respectively. An estimate for 2,3,7,8-TCDF emissions is not available.

## SECONDARY LEAD SMELTERS

### Basis for Calculation

The national activity level for secondary lead smelters for 1990 is 948,000 tons lead produced.<sup>27</sup> National emission estimates were developed using emission factors, control technology, and production data compiled under the Secondary Lead Smelting NESHAP program.<sup>28</sup>

There are three principal furnace types in operation at secondary lead smelting facilities in the U.S.: the blast furnace, the rotary furnace and the reverberatory furnace. Emission control technologies used include baghouses or a baghouse with a scrubber.

Table A-4 lists the emission factors that were used to develop the national CDD/CDF emissions estimate for secondary lead smelters. The dioxin/furan emission factors were derived from industry test reports of three facilities representing the three principal furnace types in use.<sup>29-31</sup> Controlled (baghouse and scrubber) and uncontrolled (baghouse only) emission factors for each furnace type were input into the NESHAP industry database to estimate State level emissions. Fully speciated dioxin/furan profiles were available to calculate 2,3,7,8-TCDD toxic equivalency.<sup>28</sup>

**Table A-4. Secondary Lead Smelting Emission Factors (lb/ton Lead Produced)**

<b>Pollutant</b>	<b>Baghouse Outlet</b>	<b>Scrubber Outlet</b>
<b>Rotary Furnace</b>		
2,3,7,8-TCDD	$3.16 \times 10^{-10}$	$3.96 \times 10^{-10}$
2,3,7,8-TCDF	$2.00 \times 10^{-9}$	$2.00 \times 10^{-9}$
2,3,7,8-TCDD TEQ	$1.42 \times 10^{-9}$	$1.21 \times 10^{-10}$
Total CDD	$1.49 \times 10^{-8}$	$1.85 \times 10^{-9}$
Total CDF	$5.16 \times 10^{-8}$	$5.16 \times 10^{-8}$

**Table A-4. Secondary Lead Smelting Emission Factors (lb/ton Lead Produced) (Continued)**

Pollutant	Baghouse Outlet	Scrubber Outlet
<b>Blast Furnace</b>		
2,3,7,8-TCDD	$4.46 \times 10^{-9}$	$5.38 \times 10^{-10}$
2,3,7,8-TCDF	$1.85 \times 10^{-8}$	$1.97 \times 10^{-9}$
2,3,7,8-TCDD TEQ	$1.76 \times 10^{-8}$	$1.68 \times 10^{-9}$
Total CDD	$2.94 \times 10^{-7}$	$2.26 \times 10^{-8}$
Total CDF	$5.10 \times 10^{-7}$	$4.74 \times 10^{-8}$
<b>Blast/Reverb Furnace</b>		
2,3,7,8-TCDD	$1.48 \times 10^{-10}$	$1.75 \times 10^{-10}$
2,3,7,8-TCDF	$8.34 \times 10^{-9}$	$2.88 \times 10^{-9}$
2,3,7,8-TCDD TEQ	$2.68 \times 10^{-9}$	$8.14 \times 10^{-10}$
Total CDD	$1.12 \times 10^{-8}$	$1.42 \times 10^{-8}$
Total CDF	$7.66 \times 10^{-8}$	$3.16 \times 10^{-8}$

The NESHAP estimates for dioxins/furans emissions are as follows:

- 2,3,7,8-TCDD -  $1.95 \times 10^{-3}$  lb/yr
- 2,3,7,8-TCDF -  $1.20 \times 10^{-2}$  lb/yr
- 2,3,7,8-TCDD TEQ -  $8.49 \times 10^{-3}$  lb/yr
- Total CDD -  $1.27 \times 10^{-1}$  lb/yr
- Total CDF -  $2.50 \times 10^{-1}$  lb/yr

## SECONDARY ALUMINUM SMELTERS

### Basis for Calculation

A national 2,3,7,8-TCDD TEQ emissions estimate for secondary aluminum production was developed from data provided by The Aluminum Association to the U.S. EPA.<sup>32,33</sup> Data that could be used to develop mass emissions estimates of dioxins/furans were not available.

The emissions estimate is based on model processes that represent typical processes and emission controls used by the secondary aluminum industry. An annual 2,3,7,8-TCDD TEQ emission rate was developed for each process/control configuration, based on 8,760 hours of operation per year. In addition, a utilization factor (the percent of time that the process is actually in operation) was developed for each configuration and the number of process units for each configuration were identified. To estimate actual annual TEQ emissions from a process/control, the TEQ emission rate (lb/yr) was multiplied by the utilization factor (percent or fraction) and the number of process units in operation. The data used to develop the emissions estimates are presented in Table A-5.

**Table A-5**

<b>Process</b>	<b>Controls</b>	<b>TEQ Emission Rate (lb/yr)</b>	<b>Utilization Factor</b>	<b>Number of Units</b>	<b>TEQ Emissions (lbs)</b>
Scrap Dyers	Afterburner	$1.3 \times 10^{-2}$	0.8	19	$2.0 \times 10^{-1}$
Scrap Dyers	Afterburner/ Baghouse	$5.9 \times 10^{-3}$	0.8	5	$2.4 \times 10^{-2}$
Delacquering Units	Afterburner	$1.5 \times 10^{-4}$	0.8	14	$1.7 \times 10^{-3}$
Delacquering Units	Afterburner/ Baghouse	$2.0 \times 10^{-5}$	0.8	7	$1.1 \times 10^{-4}$
Foundry Side-wells	Baghouse	$5.1 \times 10^{-4}$	0.7	41	$1.5 \times 10^{-2}$
Foundry Side-wells	Uncontrolled	$4.25 \times 10^{-3}$	0.7	39	$1.2 \times 10^{-1}$
Nonfoundry Side-wells	Uncontrolled	$5.6 \times 10^{-5}$	0.8	8	$3.6 \times 10^{-4}$
Other Reverberatory Furnaces	Uncontrolled	$5.6 \times 10^{-5}$	0.8	564	$2.5 \times 10^{-2}$
Total Emissions					$3.8 \times 10^{-1}$



## DRUM AND BARREL RECLAMATION/INCINERATION

### Basis for Calculation

Approximately 2.8 to 6.4 million 55-gallon drums are reconditioned annually in the United States.<sup>2</sup> For purposes of this report, the average national activity for 1990 is 4,600,000 drums reclaimed.<sup>2</sup> National emission estimates were made using emission factors developed from one facility test report and the reported total number of drums thermally reclaimed.

2,3,7,8-TCDD/TCDF isomer specific emission factors and homologue totals were used in calculating 2,3,7,8-TCDD TEQs.

Activity Level	2,3,7,8-TCDD Emission Factor	2,3,7,8-TCDF Emission Factor	2,3,7,8-TCDD TEQ Emission Factor
4.60x10 <sup>6</sup> 55-gallon drums/yr reclaimed	4.61x10 <sup>-9</sup> lb/10 <sup>3</sup> drums reclaimed	8.05x10 <sup>-8</sup> lb/10 <sup>3</sup> drums reclaimed	1.09x10 <sup>-7</sup> lb/10 <sup>3</sup> drums reclaimed

### Example Calculation

$$\begin{aligned} 2,3,7,8\text{-TCDD national emissions estimate} &= (4.60 \times 10^6 \text{ drum/yr reclaimed}) \\ &\quad \times (4.61 \times 10^{-9} \text{ lb/10}^3 \text{ drum}) \\ &= 2.12 \times 10^{-5} \text{ lb/yr} \end{aligned}$$

$$\begin{aligned} 2,3,7,8\text{-TCDF national emissions estimate} &= (4.60 \times 10^6 \text{ drum/yr reclaimed}) \\ &\quad \times (8.05 \times 10^{-8} \text{ lb/10}^3 \text{ drum}) \\ &= 3.70 \times 10^{-4} \text{ lb/yr} \end{aligned}$$

$$\begin{aligned} 2,3,7,8\text{-TCDD TEQ national emissions estimate} &= (4.60 \times 10^6 \text{ drum/yr reclaimed}) \\ &\quad \times (1.09 \times 10^{-7} \text{ lb/10}^3 \text{ drum}) \\ &= 5.01 \times 10^{-4} \text{ lb/yr} \end{aligned}$$

## ON-ROAD MOBILE SOURCES

### Basis for Calculation

The Federal Highway Administration's (FHWA) estimated 1992 national activity level for on-road mobile sources is  $2.2398 \times 10^{12}$  vehicle miles of travel (VMT).<sup>34</sup> This national activity level estimate was developed from the 1992 annual Highway Performance Monitoring System (HPMS) reports from each State in the nation; the HPMS reports are the standardized format for reporting vehicle activity levels expressed as VMT to the FHWA. The VMT estimates account for travel by passenger cars, trucks, and motorcycles on all urban and rural roadways within each State.

The emission factors developed for this category reflect the level of pollution control and the fuel type for the vehicles from which the emissions were originally sampled. Using EPA's MOBILE5 model, separate dioxin/furan emission factors were derived for unleaded gasoline powered vehicles (0.36 pg TEQ/km, for a national annual emission range of 0.4 to 4.1 g TEQ/yr), leaded gasoline powered vehicles (range of 1.1 to 108 pg TEQ/km, for a national annual emission range of 0.2 to 19 g TEQ), and diesel powered vehicles (0.5 ng TEQ/km, for a national annual emission range of 27 to 270 g TEQ/yr).<sup>35</sup>

The VMT mix distribution in MOBILE5a represents the national average distribution of VMT among eight gasoline and diesel vehicle classes. The combined fraction for gasoline vehicles in the MOBILE5a distribution is 94 percent; for diesel vehicles it is 6 percent.

Activity Level	2,3,7,8-TCDD Emission Factor	2,3,7,8-TCDF Emission Factor	2,3,7,8-TCDD TEQ Emission Factor
$2.2398 \times 10^{12}$ VMT	$3.60 \times 10^{-15}$ lb/VMT	$5.65 \times 10^{-14}$ lb/VMT	$8.85 \times 10^{-14}$ lb/VMT

### Example Calculation

$$\begin{aligned} 2,3,7,8\text{-TCDD TEQ national emissions estimate} &= (2.2398 \times 10^{12} \text{ VMT/yr}) \\ &\quad \times (8.85 \times 10^{-14} \text{ lb/VMT}) \\ &= 1.98 \times 10^{-1} \text{ lb/yr} \end{aligned}$$

$$\begin{aligned} 2,3,7,8\text{-TCDD national emissions estimate} &= (2.2398 \times 10^{12} \text{ VMT/yr}) \\ &\quad \times (3.60 \times 10^{-15} \text{ lb/VMT}) \\ &= 8.06 \times 10^{-3} \text{ lb/yr} \end{aligned}$$

$$\begin{aligned} 2,3,7,8\text{-TCDF national emissions estimate} &= (2.2398 \times 10^{12} \text{ VMT/yr}) \\ &\quad \times (5.65 \times 10^{-14} \text{ lb/VMT}) \\ &= 1.27 \times 10^{-1} \text{ lb/yr} \end{aligned}$$

## PULP AND PAPER--KRAFT RECOVERY FURNACES

### Basis for Calculation

The national activity level for pulp and paper industry kraft recovery furnaces for 1990 is 31,080,000 tons of black liquor solids burned.<sup>36</sup> The emission factor for 2,3,7,8-TCDD TEQ, as calculated from data collected by the National Council of the Paper Industry for Air and Stream Improvement (NCASI), is presented below for kraft recovery furnaces.<sup>17</sup> Emission factors and the national activity data from kraft recovery furnaces were used to estimate 2,3,7,8-TCDD TEQ emissions.

Activity Level	2,3,7,8-TCDD TEQ Emission Factor
$3.11 \times 10^7$ ton black liquor solids burned	$2.20 \times 10^{-11}$ lb/ton black liquor solids

### Example Calculation

$$\begin{aligned} 2,3,7,8\text{-TCDD TEQ national emissions estimate} &= (3.11 \times 10^7 \text{ ton/yr black liquor solids bur} \\ &\quad \times (2.2 \times 10^{-11} \text{ lb/ton black liquor solids}) \\ &= 6.84 \times 10^{-4} \text{ lb/yr} \end{aligned}$$

## WOOD TREATMENT

### Basis for Calculation

The most current national activity data acquired for PCP wood treatment is for 1988 and is 10,800 tons of PCP used in wood treatment operations.<sup>2</sup> The dioxin/furan emission factors were derived using reported average emissions of five pressure treatment facilities in California and their average associated PCP consumption.<sup>37</sup> The emission data used in factor development were derived using known concentrations of dioxin/furan species in PCP and calculated fugitive emission rates. Homologue totals were used in calculating 2,3,7,8-TCDD TEQs. It was assumed that because no 2,3,7,8-tetra congener contamination was detected in commercial PCP after dilution and mixture with co-solvents, 2,3,7,8-TCDD would not be emitted to the atmosphere from the PCP wood treatment process.<sup>37</sup>

Activity Level	2,3,7,8-TCDD TEQ Emission Factor
1.08x10 <sup>4</sup> ton PCP used for wood treatment	7.06x10 <sup>-6</sup> lb/ton PCP

### Example Calculation

$$\begin{aligned} 2,3,7,8\text{-TCDD TEQ national emissions estimate} &= (7.06 \times 10^{-6} \text{ lb/ton PCP}) \\ &\quad \times (1.08 \times 10^4 \text{ ton/yr PCP}) \\ &= 7.62 \times 10^{-2} \text{ lb/yr} \end{aligned}$$

## CARBON REGENERATION/REACTIVATION

### Basis for Calculation

The only data available for the amount of activated carbon consumed in a year is for water and wastewater treatment operations. The national activity level for activated carbon consumption in water and wastewater treatment operations for 1990 is 71,900 tons of activated carbon consumed.<sup>38</sup> For calculational purposes, it is assumed that all activated carbon used in water and wastewater treatment is regenerated. The dioxin/furan emission factors were derived by a weighted average of emission factors.<sup>2</sup> The weighted emission factors reflect the following assumptions: 50 percent of the total amount of activated carbon thermally reactivated is from industrial uses and occurs in large multiple-hearth or similar furnace types; 50 percent of the total is used for municipal wastewater/potable water treatment applications. 2,3,7,8-TCDD/TCDF isomer specific emission factors and homologue totals were used in calculating 2,3,7,8-TCDD toxic equivalency.

Activity Level	2,3,7,8-TCDD Emission Factor	2,3,7,8-TCDF Emission Factor	2,3,7,8-TCDD TEQ Emission Factor
7.19x10 <sup>4</sup> ton carbon reactivated	2.10x10 <sup>-10</sup> lb/ton carbon reactivated	1.36x10 <sup>-9</sup> lb/ton carbon reactivated	3.46x10 <sup>-9</sup> lb/ton carbon reactivated

### Example Calculation

$$\begin{aligned} 2,3,7,8\text{-TCDD national emissions estimate} &= (7.19 \times 10^4 \text{ ton/yr carbon}) \\ &\quad \times (2.10 \times 10^{-10} \text{ lb/ton carbon}) \\ &= 1.51 \times 10^{-5} \text{ lb/yr} \end{aligned}$$

$$\begin{aligned} 2,3,7,8\text{-TCDF national emissions estimate} &= (7.19 \times 10^4 \text{ ton/yr carbon}) \\ &\quad \times (1.36 \times 10^{-9} \text{ lb/ton carbon}) \\ &= 9.78 \times 10^{-5} \text{ lb/yr} \end{aligned}$$

$$\begin{aligned} 2,3,7,8\text{-TCDD TEQ national emissions estimate} &= (7.19 \times 10^4 \text{ ton/yr carbon}) \\ &\quad \times (3.46 \times 10^{-9} \text{ lb/ton carbon}) \\ &= 2.49 \times 10^{-4} \text{ lb/yr} \end{aligned}$$

## FOREST FIRES

### Basis for Calculation

Dioxin/furan emission estimates attributed to forest fires were based on a methodology developed by EPA's Office of Health and Environmental Assessment (this office is now named the National Center for Environmental Assessment).<sup>39</sup> An average of 5.1 million acres of biomass are burned in wildfires each year in the U.S., based on 40 years of USDA Forest Service data. In 1989, 5.1 million acres were burned as a result of prescribed burning. Biomass consumption rates were estimated at 10.4 ton/acre for wildfires, and 8.2 ton/acre for prescribed fires. From these estimates, the national activity level for wildfires was estimated at 53 million tons of biomass consumed and was estimated for prescribed fires at 42 million tons, for a total of 95 million tons.<sup>2</sup>

Applying the emission factor developed for combustion in a woodstove [which is 0.19 lb TEQ/ton (1 ng TEQ/kg) biomass burned], annual TEQ emissions from forest fires were estimated at 0.19 lb (86 g), with projected range from 0.06 lb (27 g) to 0.6 lb (270 g) TEQ/yr.<sup>40</sup>

Activity Level	2,3,7,8-TCDD TEQ Emission Factor
$9.50 \times 10^7$ ton biomass burned	$2.00 \times 10^{-9}$ lb/ton biomass burned

### Example Calculation

$$\begin{aligned} 2,3,7,8\text{-TCDD TEQ national emissions estimate} &= (9.50 \times 10^7 \text{ ton/yr biomass burned}) \\ &\quad \times (2.00 \times 10^{-9} \text{ lb/ton biomass burned}) \\ &= 1.90 \times 10^{-1} \text{ lb/yr} \end{aligned}$$



## CREMATORIES

### Basis for Calculation

Emission estimates attributed to crematories were based on emission factors from a CARB source test report<sup>41</sup> and 1991 activity data regarding the number of cremations per year.<sup>42</sup> The test report included emission factor data for 2,3,7,8-TCDD and 2,3,7,8-TCDF but not for 2,3,7,8-TCDD TEQ. The 2,3,7,8-TCDD and 2,3,7,8-TCDF emission factors were multiplied by the activity level to calculate national 2,3,7,8-TCDD/TCDF emissions from crematories. An emission factor for 2,3,7,8-TCDD TEQ was not available and, therefore, a national emissions estimate for 2,3,7,8-TCDD TEQ from crematories was not developed.

Activity Level	2,3,7,8-TCDD Emission Factor	2,3,7,8-TCDF Emission Factor
400,500 bodies/yr	$4.58 \times 10^{-14}$ lb/body	$3.31 \times 10^{-13}$ lb/body

### Example Calculation

$$\begin{aligned} 2,3,7,8\text{-TCDD national emissions estimate} &= (4.58 \times 10^{-14} \text{ lb/body}) \times (400,500 \text{ bodies/yr}) \\ &= 1.83 \times 10^{-8} \text{ lb/yr} \\ 2,3,7,8\text{-TCDF national emissions estimate} &= (3.31 \times 10^{-13} \text{ lb/body}) \times (400,500 \text{ bodies/yr}) \\ &= 1.33 \times 10^{-7} \text{ lb/yr} \end{aligned}$$

## REMAINING SOURCE CATEGORIES

National dioxin/furan emissions from the following source categories could not be calculated because of lack of additional information (e.g., activity data):

- Industrial waste incineration;
- Scrap metal incineration;
- PCB fires;
- Municipal solid waste landfills; and
- Organic chemical manufacturing.

## REFERENCES

1. National Dioxin Emission Estimates from Municipal Waste Combustors. U.S. Environmental Protection Agency, Emission Standards Division, Office of Air Quality Planning and Standards, Research Triangle Park, North Carolina. June 1996. Docket A-90-45, Item VII-A-001.
2. U.S. Environmental Protection Agency. *Emissions Inventory of Section 112(c)(6) Pollutants: Polycyclic Organic Matter (POM), 2,3,7,8-Tetrachlorodibenzo-P-Dioxin (TCDD)/2,3,7,8-Tetrachlorodibenzofuran (TCDF), Polychlorinated Biphenyl Compounds (PCBs), Hexachlorobenzene, Mercury, and Alkylated Lead*. Draft Report. Office of Air Quality Planning and Standards, Research Triangle Park, North Carolina, 1996.
3. U.S. EPA. Municipal Waste Combustors - Background Information for Proposed Guidelines for Existing Facilities. EPA-450/3-89-27e. August 1989.
4. U.S. EPA. *Compilation of Air Pollutant Emission Factors*, 5th ed. , Vol. I: Stationary Point and Area Sources. Research Triangle Park, North Carolina: U.S. Environmental Protection Agency, 1995.
5. Federal Register, Vol. 61, No. 120, June 20, 1996. Standards of Performance for New Stationary Sources and Emission Guidelines for Existing Sources: Medical Waste Incinerators. Proposed Rule.
6. National Dioxin Emissions From Medical Waste Incinerators. U.S. Environmental Protection Agency, Emission Standards Division, Office of Air Quality Planning and Standards, Research Triangle Park, North Carolina. June 1996. Docket #A-91-61, ITCM, IV-A-007.
7. U.S. EPA. *Emission Factor Documentation for AP-42, Chapter 2.5 Sewage Sludge Incineration*. Research Triangle Park, North Carolina: U.S. Environmental Protection Agency, 1993. pp. 2.5-13 to 2.5-17.
8. Oppelt, E.T. Incineration of Hazardous Waste--A Critical Review. *Journal of Air Pollution Control Association*. 37(5):558-586, 1987.
9. Memorandum from G. Rizeq, EER Corporation, to F. Behan, U.S. Environmental Protection Agency. "TEQ and Mercury National Emissions Estimate for Hazardous Waste Incinerators." April 3, 1997.

10. Draft Technical Support Document: *HAPs National Emissions Estimate for Hazardous Waste Combustor Systems*. Prepared by EER Corporation for the Environmental Protection Agency's Office of Solid Waste (OSW). April, 1997.
11. Memorandum from G. Rizeq, EER Corporation, to F. Bekan, U.S. Environmental Protection Agency. "National Emissions Estimates for TEQ and Mercury." April 7, 1997.
12. Memorandum from E. Heath, Research Triangle Institute to J. Wood, U.S. Environmental Protection Agency. March 18, 1996. "Dioxin/Furan Toxic Equivalent Emissions from Cement Kilns that do not Burn Hazardous Waste."
13. Draft Technical Support Document for Hazardous Waste Combustion (HWC) MACT Standards, Volume II: HWC Emissions Database, Appendix A: Cement Kiln Detailed Data Listing, U.S. Environmental Protection Agency, Office of Solid Waste and Emergency Response. September, 1995.
14. Radian Corporation. Modesto Energy Company Waste Tire-to-Energy Facility, Westley, California, Final Emission Test Report. Report No. 243-047-20. Research Triangle Park, North Carolina: Radian Corporation, 1988.
15. U.S. EPA. *Summary and Markets for Scrap Tires*. EPA/530-SW-90-074B. Washington, D.C.: Office of Solid Waste and Emergency Response, U.S. Environmental Protection Agency, 1992.
16. Cole, J. (Research Triangle Institute). Memorandum to W. Maxwell, (U.S. Environmental Protection Agency), Research Triangle Park, North Carolina. January 19, 1995.
17. Someshwar, A.V. *Summary of Mill Test Reports on Wood Residue Combustion, Black Liquor Combustion, and Kraft Mill Sludge Burning*. NCASI Files. Gainesville, Florida: National Council of the Paper Industry for Air and Stream Improvement, Inc., 1995.
18. Energy Information Administration. *Estimate of U.S. Biofuels Consumption 1990*. DOE/EIA-0548(90). Washington, D.C.: Office of Coal, Nuclear, Electric, and Alternative Fuels, U.S. Department of Energy, 1991. p. 9.
19. Energy Information Administration. *State Energy Data Report*. Washington, D.C.: Office of Energy Markets and End Use, U.S. Department of Energy, 1992.
20. Energy Information Administration. February, 1993. Household Energy Consumption and Expenditures 1990. DOE/EIA-0321(90).

21. Energy Information Administration. February 1993. Household Energy Consumption and Expenditures 1990, Supplement: Regional. Office of Energy Markets and End Use. DOE/EIA-0321(90/S). pp. 30, 115, 205, and 297.
22. Letter and attachments from David Menotti, Shaw, Potts, and Trowbridge, to Anne Pope, U.S. EPA. Comments to the draft 112(c)(6) emissions inventory report. November 27, 1996.
23. U.S. EPA. June 1994. *Estimating Exposures to Dioxin-Like Compounds, Volume II: Properties, Sources, Occurrence, and Background Exposures*. External Review Draft. EPA-600/6-88-005Cb. Office of Health and Environmental Assessment, Washington, DC. pp. 3-143-3-146.
24. California Air Resources Board. *Emissions Measurement of Toxic Compounds from a Cupola Baghouse at a Steel Foundry*. Report No. ERC-61. Sacramento, California: California Air Resources Board, 1993.
25. Research Triangle Institute. 1994. *Preliminary Source Assessment for the Secondary Copper Smelting Industry*. Prepared for the U.S. Environmental Protection Agency, Research Triangle Park, North Carolina.
26. U.S. EPA. 1987. *National Dioxin Study Tier 4-Combustion Sources. Final Test Report-Site 10 Secondary Copper Recovery Cupola Furnace MET-A*. EPA-450/4-87-014s. Research Triangle Park, North Carolina.
27. Larrabee, D.A. Lead. In: U.S. Industrial Outlook 1991. U.S. Department of Commerce, International Trade Administration, Washington, DC. 1991.
28. U.S. EPA. Secondary Lead Smelting Background Information Document for Promulgated Standards. EPA-453/R-95-008B. Research Triangle Park, North Carolina.
29. U.S. EPA. Draft Emission Test Report. HAP Emission Testing a Selected Sources at a Secondary Lead Smelter. East Penn Manufacturing Company. Prepared by Roy F. Weston, Inc. 1993.
30. U.S. EPA. Draft Emission Test Report. HAP Emission Testing on Selected Sources at a Secondary Lead Smelter. Tejas Resources, Inc. Prepared by Roy F. Weston, Inc. 1992.
31. U.S. EPA. Draft Emission Test Report. HAP Emission Testing in Selected Sources at a Secondary Lead Smelter. Schulkill Metals Corporation. Prepared by Roy F. Weston, Inc. 1993.

32. Memorandum from Bob Strieter, The Aluminum Association, to Juan Santiago, U.S. Environmental Protection Agency. Annual Dioxin Emissions from Secondary Aluminum Production. May 17, 1996.
33. Memorandum from Juan Santiago, U.S. Environmental Protection Agency, to Jack Johnson, Eastern Research Group, Inc. New Dioxin/Furan Emissions Data Received from the Aluminum Association, Research Triangle Park, North Carolina. January 22, 1997.
34. U.S. Federal Highway Administration's Highway Statistics. Washington, D.C.: U.S. Department of Transportation, 1992.
35. U.S. EPA. *MOBILE5a Emission Factor Model*. Ann Arbor, Michigan: Office of Mobile Sources, U.S. Environmental Protection Agency, 1993.
36. U.S. EPA. *1990 Census of Pulp, Paper and Paperboard Manufacturing Facilities. Response to 308 Questionnaire, Part A: Technical Information*. Washington, D.C.: Office of Water, U.S. Environmental Protection Agency, 1992.
37. California Air Resources Board. *Inventory of Chlorophenol Use in the Forest Products Industry and Investigation of Related Emissions of Chlorinated Dibenzodioxins and Dibenzofurans*, Final Report. Sacramento, CA: California Air Resources Board, 1987.
38. Humer, C. Activated Carbon Plant Starts for American Novit. Chemical Marketing Reporter. June 1992.
39. U.S. EPA. *Estimating Exposure to Dioxin-like Compounds*, Volume II: Properties, Sources, Occurrence, and Background Exposures, External Review Draft. EPA-600/6-88-005 Cb. Washington, D.C.: Exposure Assessment Group, Office of Health and Environmental Assessment, U.S. Environmental Protection Agency, 1994.
40. Peterson, J. (Mt. Baker--Snoqualmie National Forest) and D. Ward (Forest Service Fire Lab). An Inventory of Particulate Matter and Air Toxic Emissions from Prescribed Fires in the United States for 1989. *Proceedings of the Air and Waste Management Association 1993 Annual Meeting and Exhibition*. Denver, Colorado. June 14 to 18, 1993.
41. California Air Resources Board. *Emissions Testing of a Propane Fired Incinerator at a Crematorium*. Report No. ERC-39. Sacramento, California: California Air Resources Board, 1992.
42. Cremation Association of North America. Cremation Statistics. *Cremationist*. Chicago, Illinois: Cremation Association of North America, 1992.